

Advanced Parsing Techniques

Announcements

- **Written Assignment 2 out**, due Monday, July 18 at 5:00PM.
 - Start early; this problem set is tricky!
- **Programming Project 2** due Wednesday, July 11 at 11:59 PM.

Where We Are

Where We Are

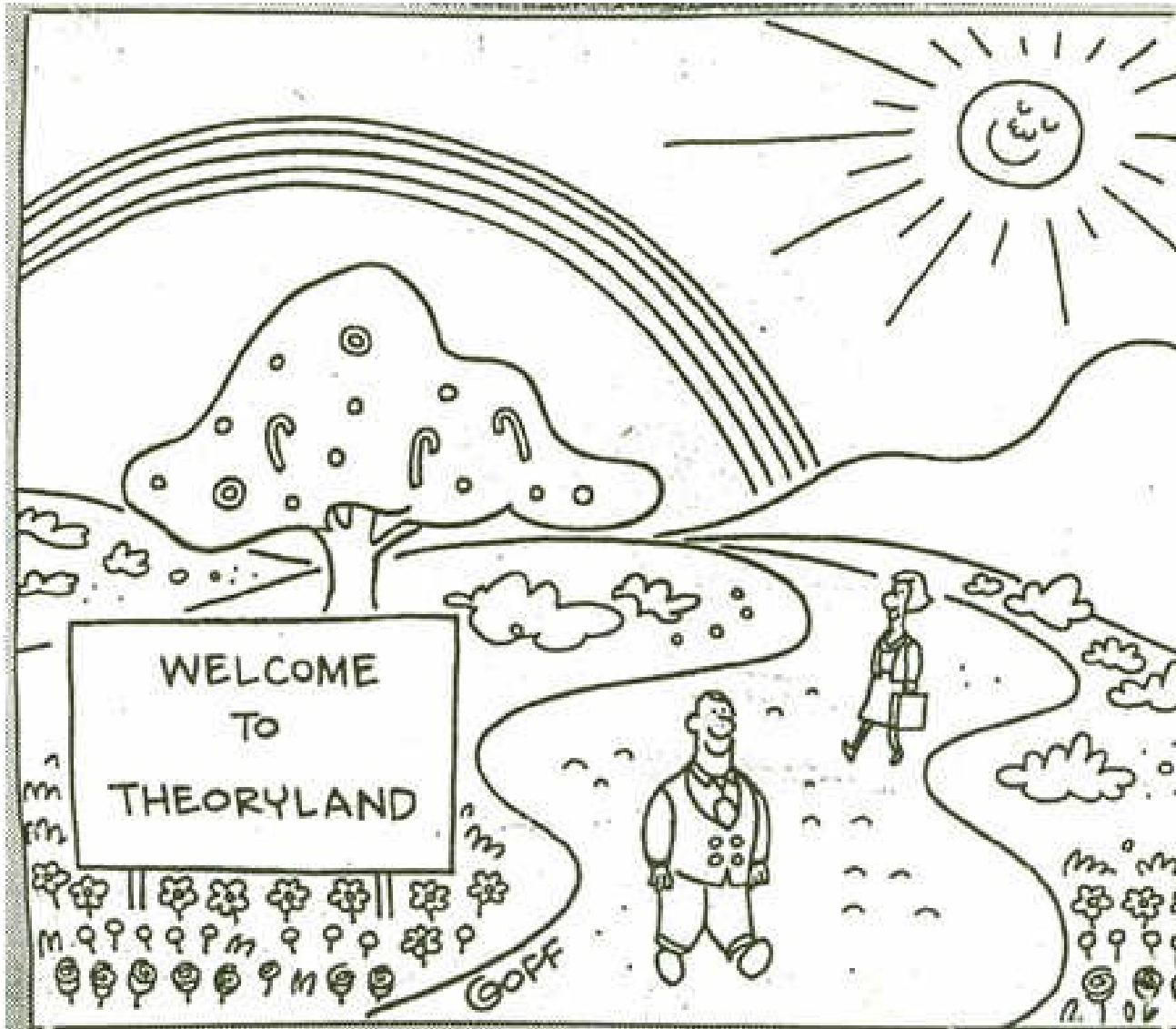

Parsing so Far

- We've explored five deterministic parsing algorithms:
 - LL(1)
 - LR(0)
 - SLR(1)
 - LALR(1)
 - LR(1)
- These algorithms all have their limitations.
- Can we parse **arbitrary** context-free grammars?

Why Parse Arbitrary Grammars?

- **They're easier to write.**
 - Can leave operator precedence and associativity out of the grammar.
 - No worries about shift/reduce or FIRST/FOLLOW conflicts.
- If ambiguous, can **filter out invalid trees** at the end.
 - Generate candidate parse trees, then eliminate them when not needed.
- **Practical concern** for some languages.
 - We need to have C and C++ compilers!

Questions for Today

- How do you go about parsing ambiguous grammars **efficiently**?
- How do you produce **all possible parse trees**?
- What else can we do with a general parser?

The Earley Parser

Motivation: The Limits of LR

- LR parsers use shift and reduce actions to reduce the input to the start symbol.
- LR parsers cannot deterministically handle shift/reduce or reduce/reduce conflicts.
- However, they can **nondeterministically** handle these conflicts by guessing which option to choose.
- What if we try **all options** and see if any of them work?

The Earley Parser

- Maintain a collection of **Earley items**, which are LR(0) items annotated with a start position.
 - The item $A \rightarrow u \cdot v @n$ means we are working on recognizing $A \rightarrow uv$, have seen u , and the start position of the item was the n th token.
- Each Earley item has a **position** in the input sequence denoting where the next symbol of input is.
- Using techniques similar to LR parsing, try to scan across the input creating these items.
- We're done when we find an item $S \rightarrow u \cdot @1$ at the very last position.

Earley in Action

$S \rightarrow E$
 $E \rightarrow E + E$
 $E \rightarrow \text{int}$

Earley in Action

int	+	int	+	int
-----	---	-----	---	-----

$S \rightarrow E$
 $E \rightarrow E + E$
 $E \rightarrow \text{int}$

Earley in Action

int + int + int

$S \rightarrow E$
 $E \rightarrow E + E$
 $E \rightarrow \text{int}$

Earley in Action

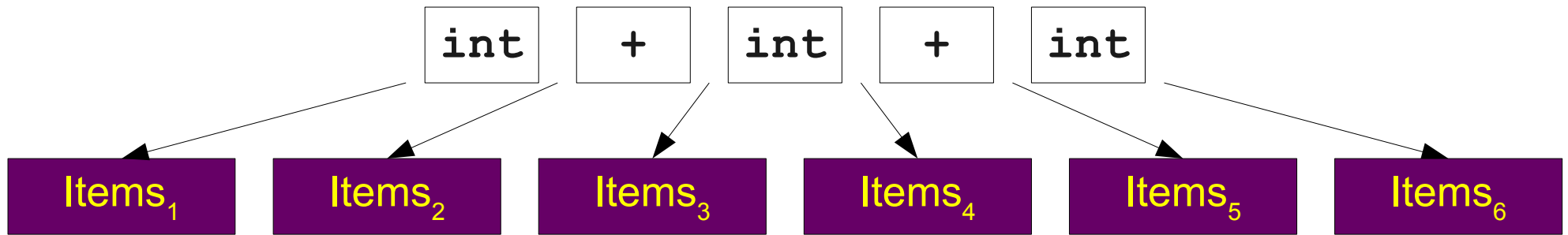

$S \rightarrow E$
 $E \rightarrow E + E$
 $E \rightarrow \text{int}$

Earley in Action

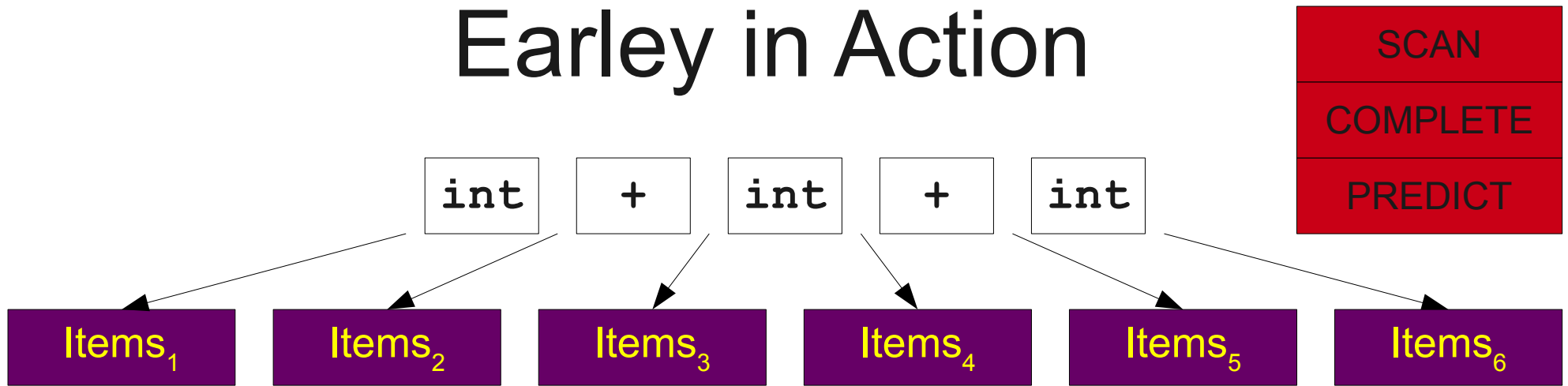

$S \rightarrow E$
 $E \rightarrow E + E$
 $E \rightarrow \text{int}$

Earley in Action

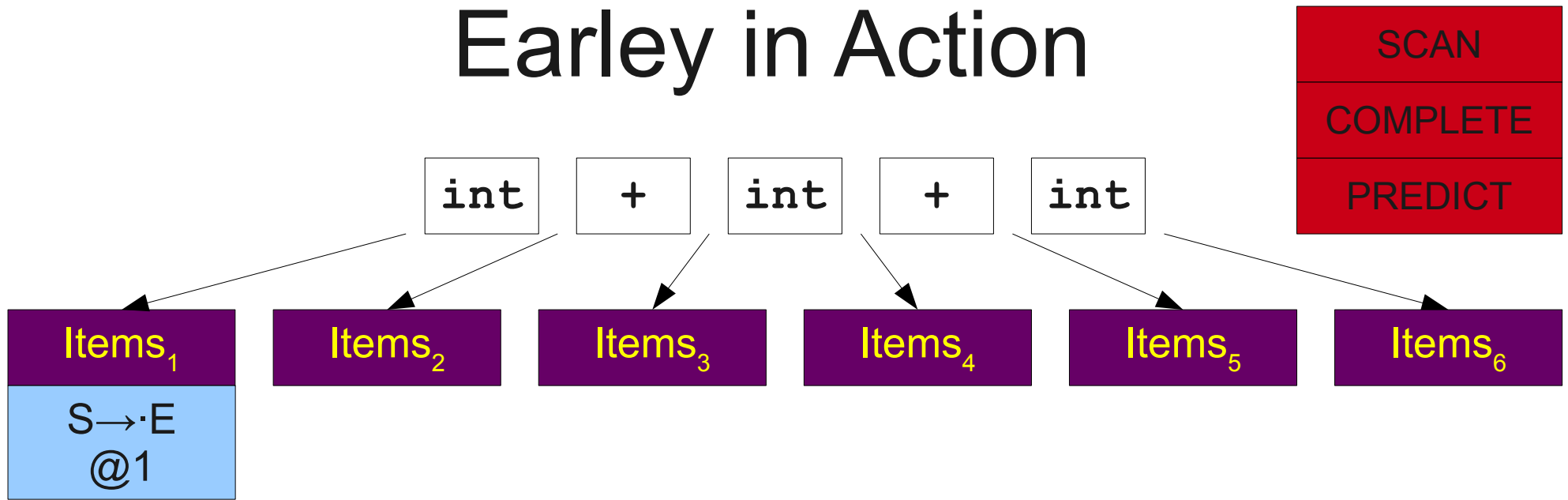

$S \rightarrow E$
 $E \rightarrow E + E$
 $E \rightarrow \text{int}$

Earley in Action

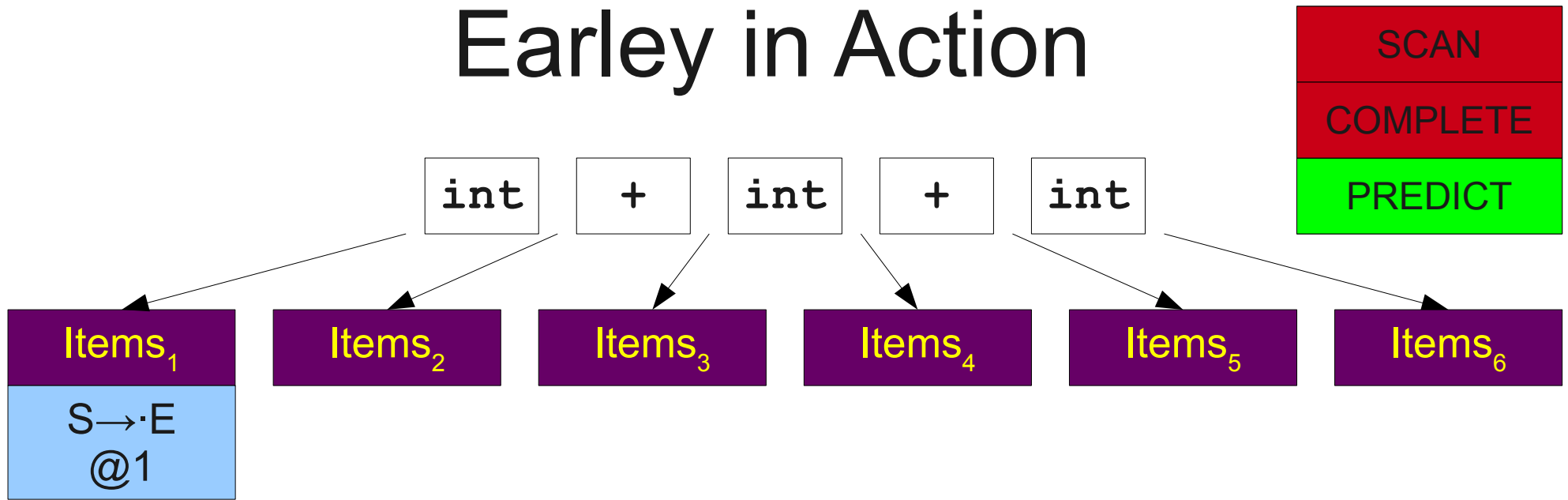

$S \rightarrow E$
 $E \rightarrow E + E$
 $E \rightarrow \text{int}$

Earley in Action

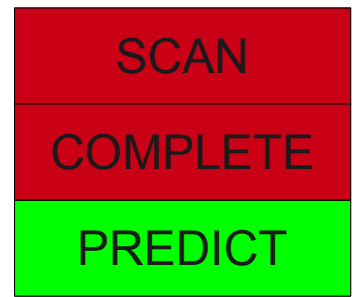

int + int + int

Items ₁
S → ·E @1
E → ·E+E @1
E → ·int @1

Items₂

Items₃

Items₄

Items₅

Items₆

S → E
E → E + E
E → int

Earley in Action

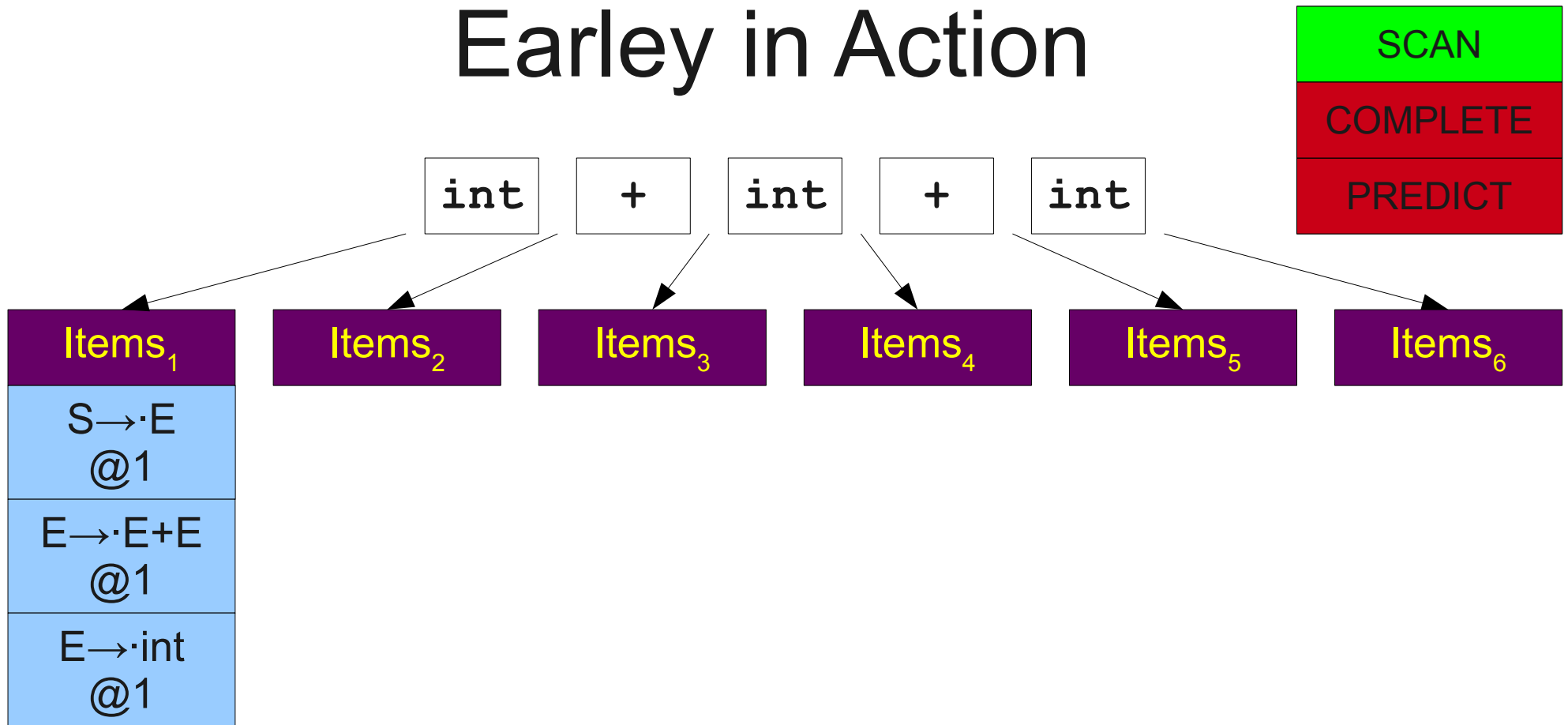

$S \rightarrow E$
 $E \rightarrow E + E$
 $E \rightarrow \text{int}$

Earley in Action

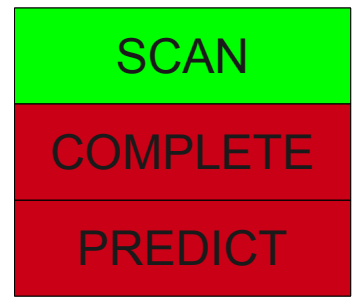

int + int + int

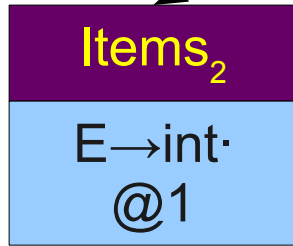
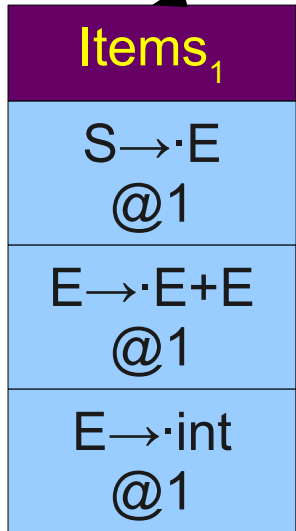

$S \rightarrow E$
 $E \rightarrow E + E$
 $E \rightarrow \text{int}$

Earley in Action

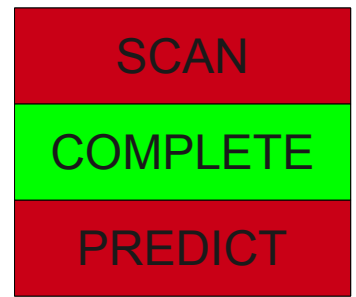

int + int + int

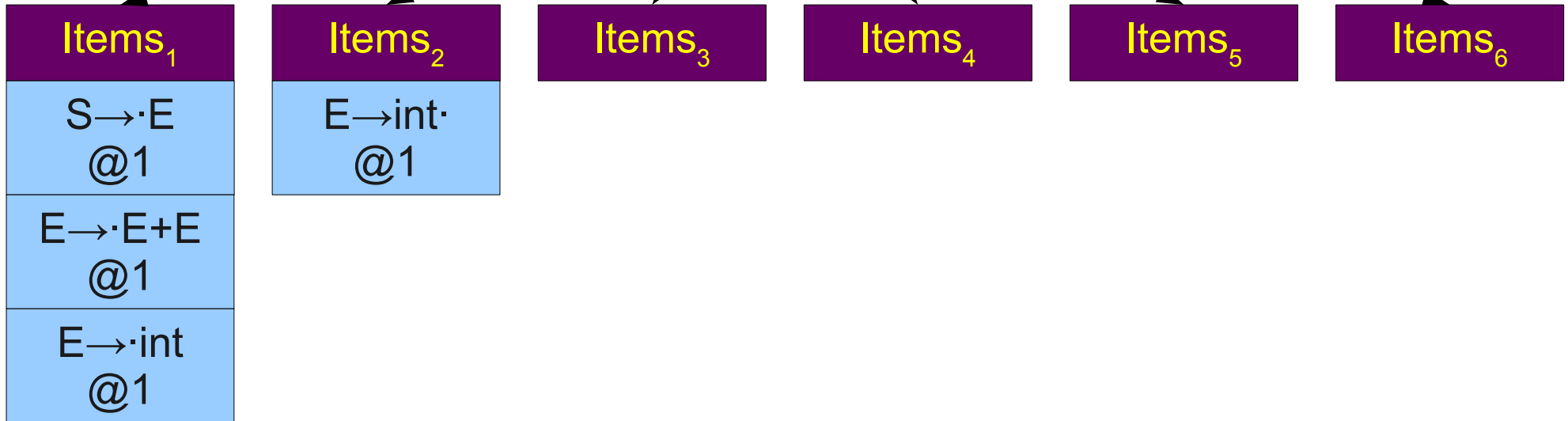

S → E
E → E + E
E → int

Earley in Action

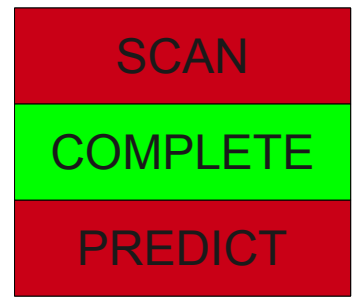

int + int + int

Items₁

$S \rightarrow \cdot E$ @1
$E \rightarrow \cdot E + E$ @1
$E \rightarrow \cdot \text{int}$ @1

Items₂

$E \rightarrow \text{int} \cdot$ @1
$S \rightarrow E \cdot$ @1
$E \rightarrow E \cdot + E$ @1

Items₃

Items₄

Items₅

Items₆

$S \rightarrow E$
 $E \rightarrow E + E$
 $E \rightarrow \text{int}$

Earley in Action

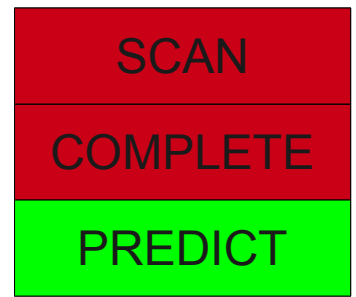

int + int + int

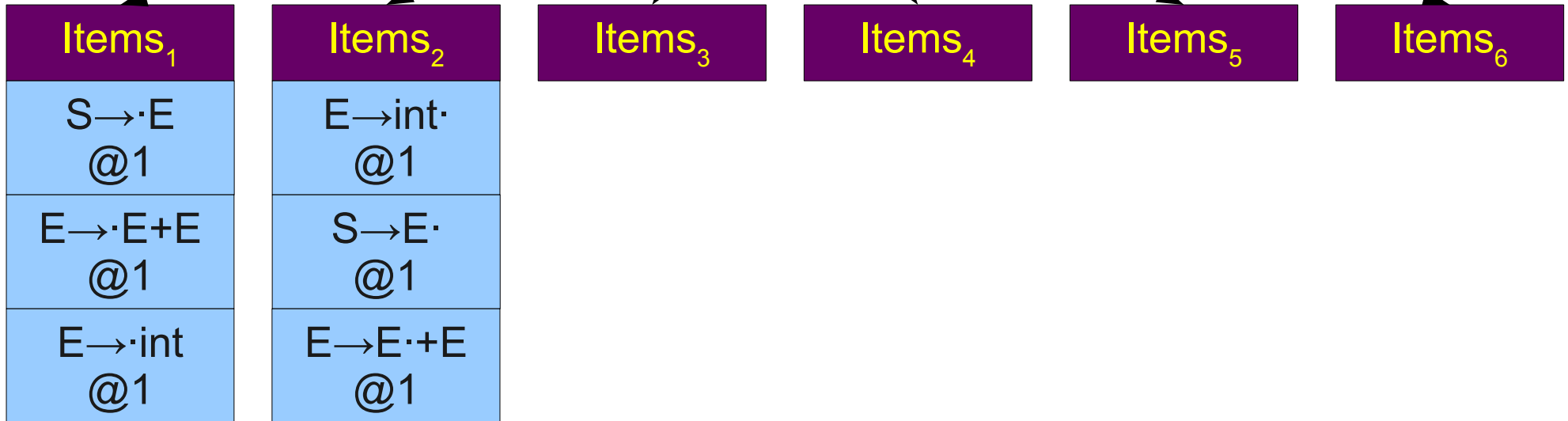

$S \rightarrow E$
 $E \rightarrow E + E$
 $E \rightarrow \text{int}$

Earley in Action

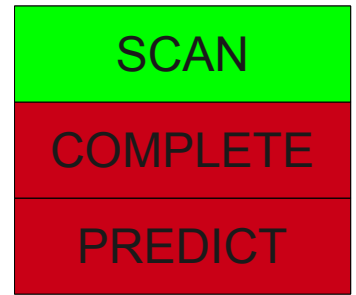

int + int + int

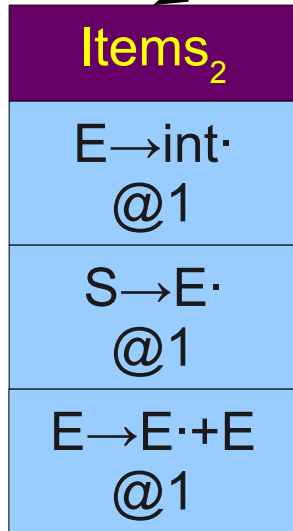
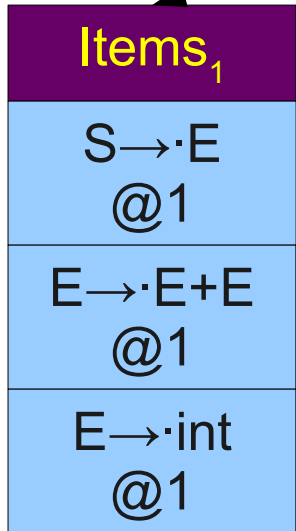

$S \rightarrow E$
 $E \rightarrow E + E$
 $E \rightarrow \text{int}$

Earley in Action

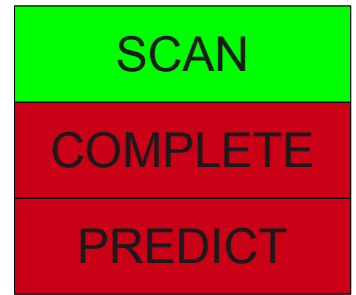

int + int + int

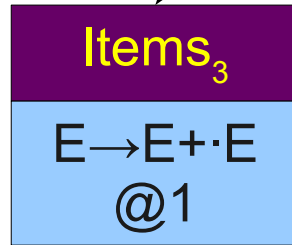
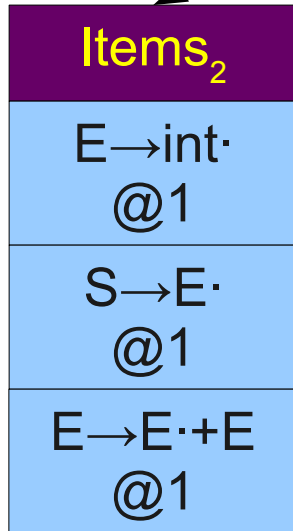
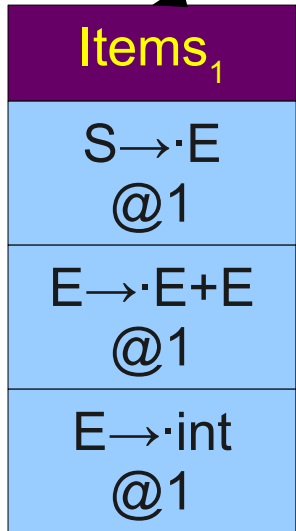

$S \rightarrow E$
 $E \rightarrow E + E$
 $E \rightarrow \text{int}$

Earley in Action

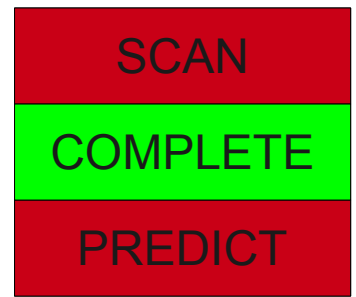

int + int + int

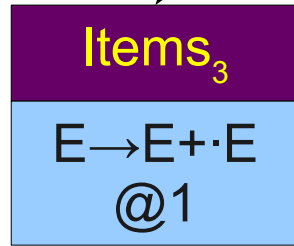
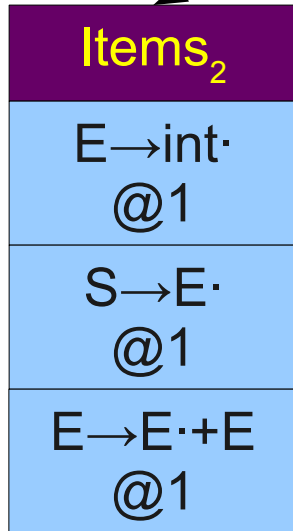
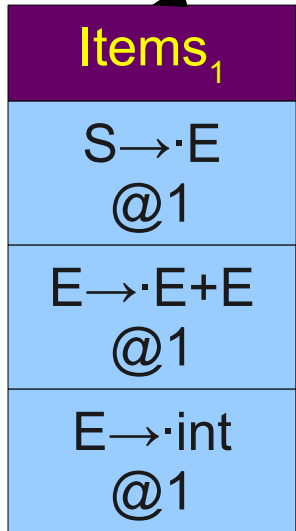

$S \rightarrow E$
 $E \rightarrow E + E$
 $E \rightarrow \text{int}$

Earley in Action

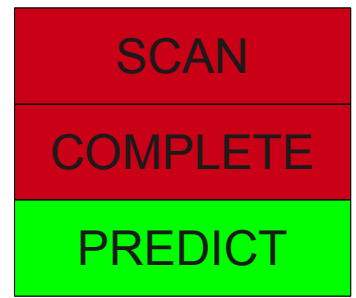

int + int + int

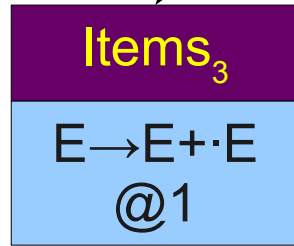
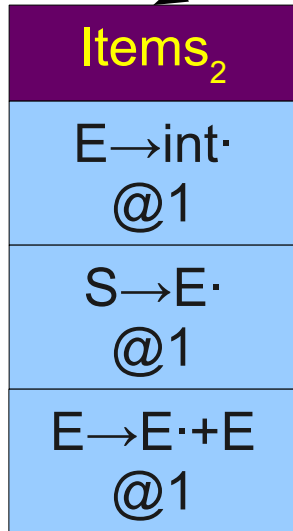
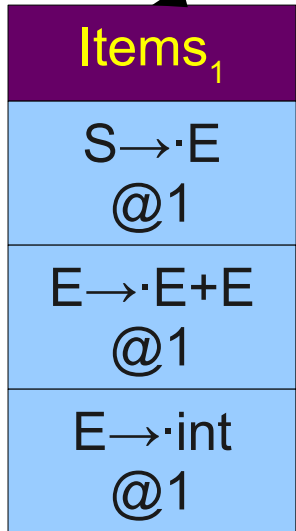

$S \rightarrow E$
 $E \rightarrow E + E$
 $E \rightarrow \text{int}$

Earley in Action



int + int + int

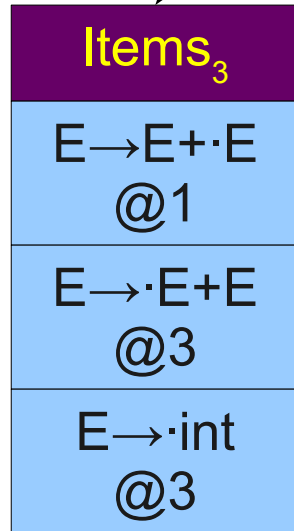
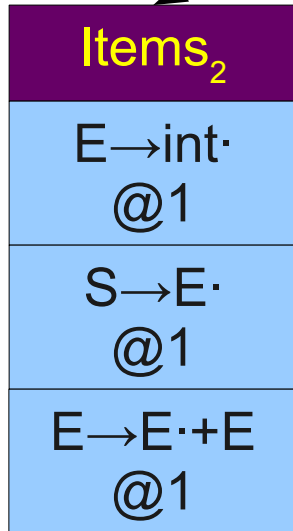
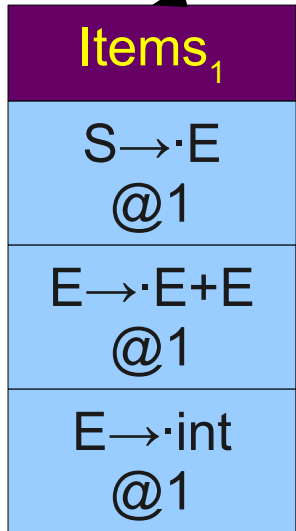

$S \rightarrow E$
 $E \rightarrow E + E$
 $E \rightarrow int$

Earley in Action

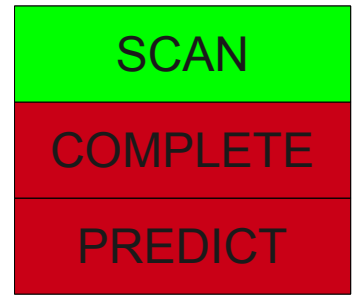

int + int + int

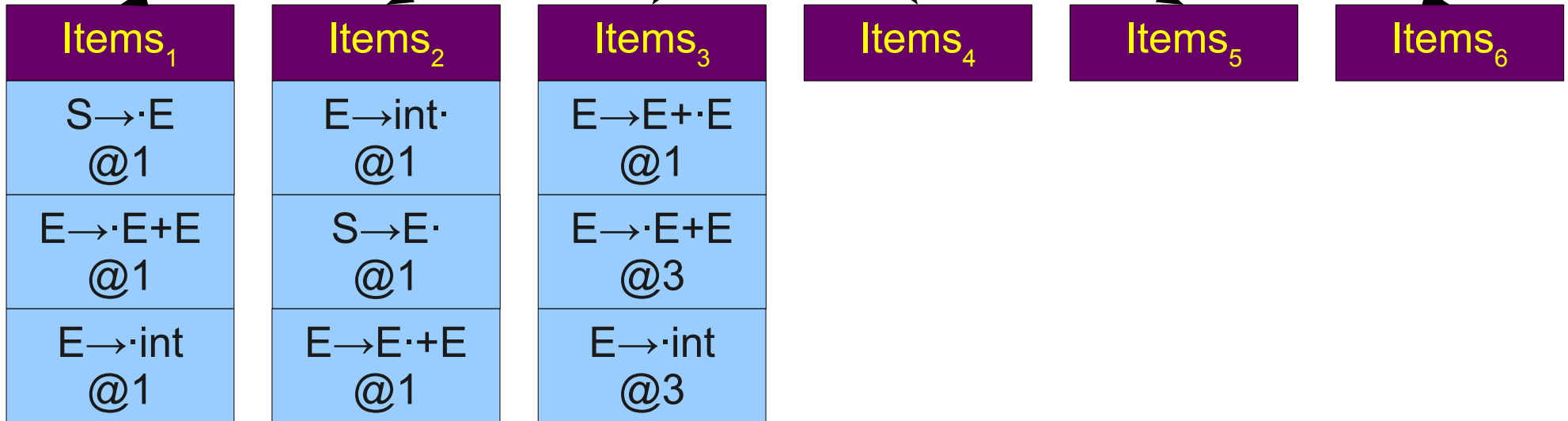

$S \rightarrow E$
 $E \rightarrow E + E$
 $E \rightarrow int$

Earley in Action

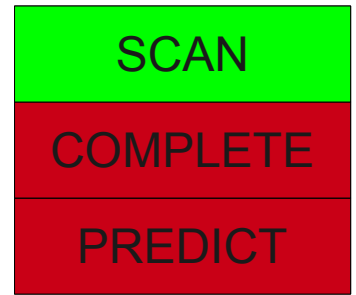

int + int + int

Items₁

$S \rightarrow \cdot E$ @1
$E \rightarrow \cdot E + E$ @1
$E \rightarrow \cdot \text{int}$ @1

Items₂

$E \rightarrow \text{int} \cdot$ @1
$S \rightarrow E \cdot$ @1
$E \rightarrow E \cdot + E$ @1

Items₃

$E \rightarrow E + \cdot E$ @1
$E \rightarrow \cdot E + E$ @3
$E \rightarrow \cdot \text{int}$ @3

Items₄

$E \rightarrow \text{int} \cdot$ @3
--

Items₅

Items₆

$S \rightarrow E$
 $E \rightarrow E + E$
 $E \rightarrow \text{int}$

Earley in Action

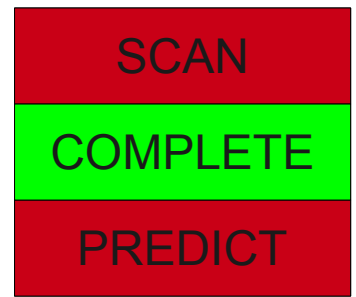

int + int + int

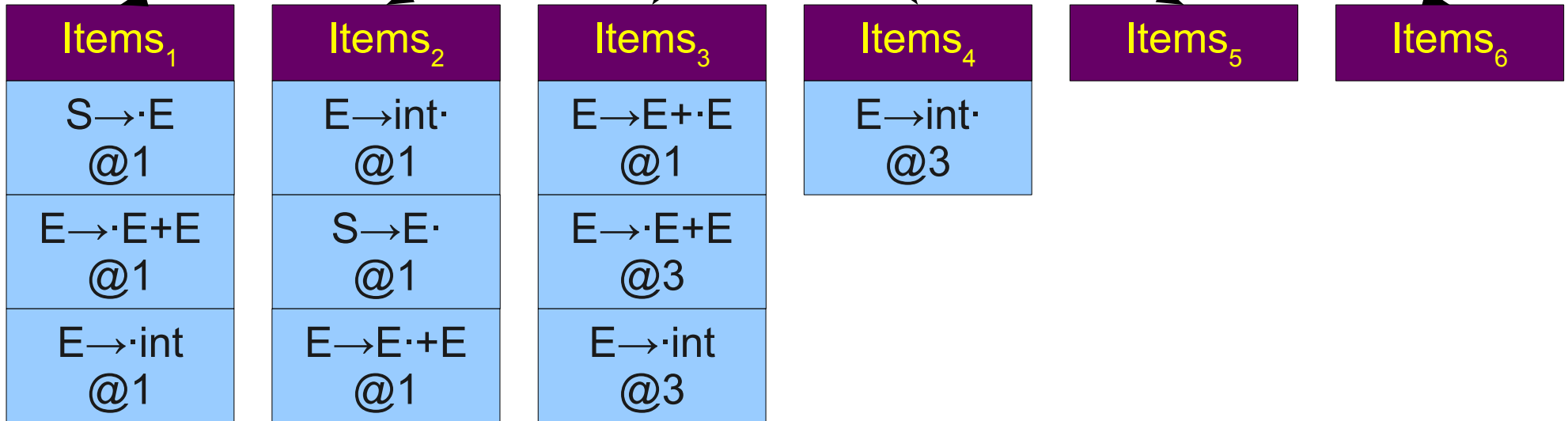

$S \rightarrow E$
 $E \rightarrow E + E$
 $E \rightarrow int$

Earley in Action

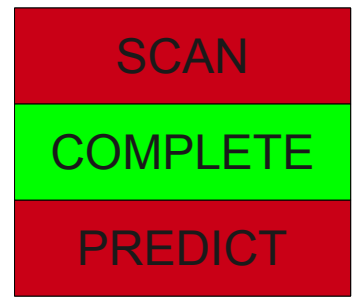

int + int + int

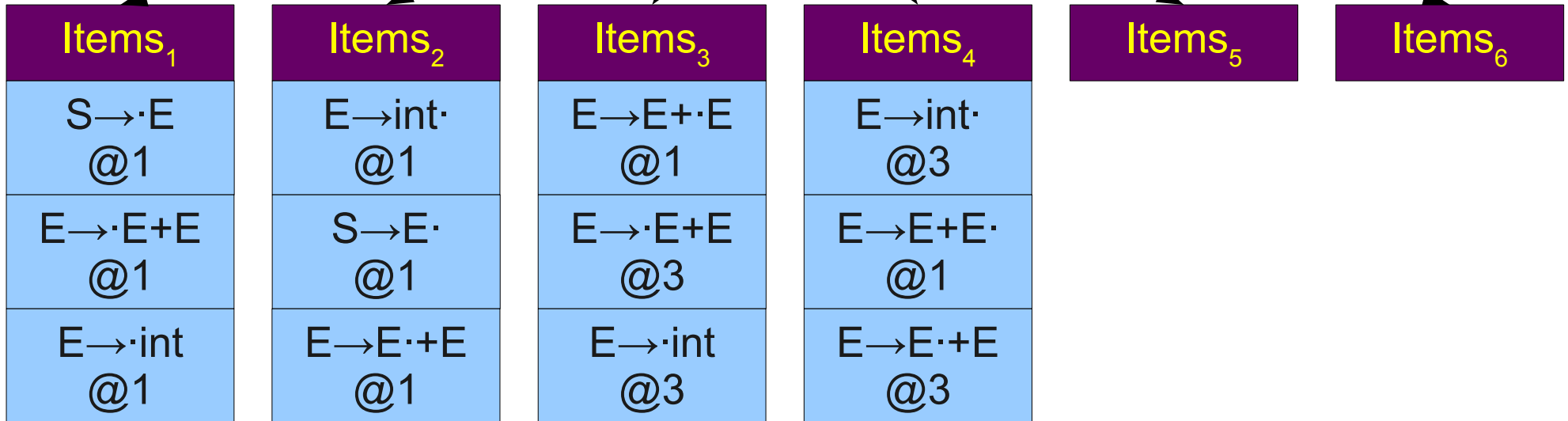

$S \rightarrow E$
 $E \rightarrow E + E$
 $E \rightarrow \text{int}$

Earley in Action

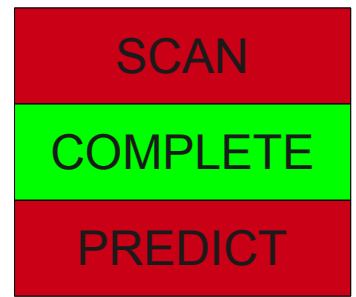

int + int + int

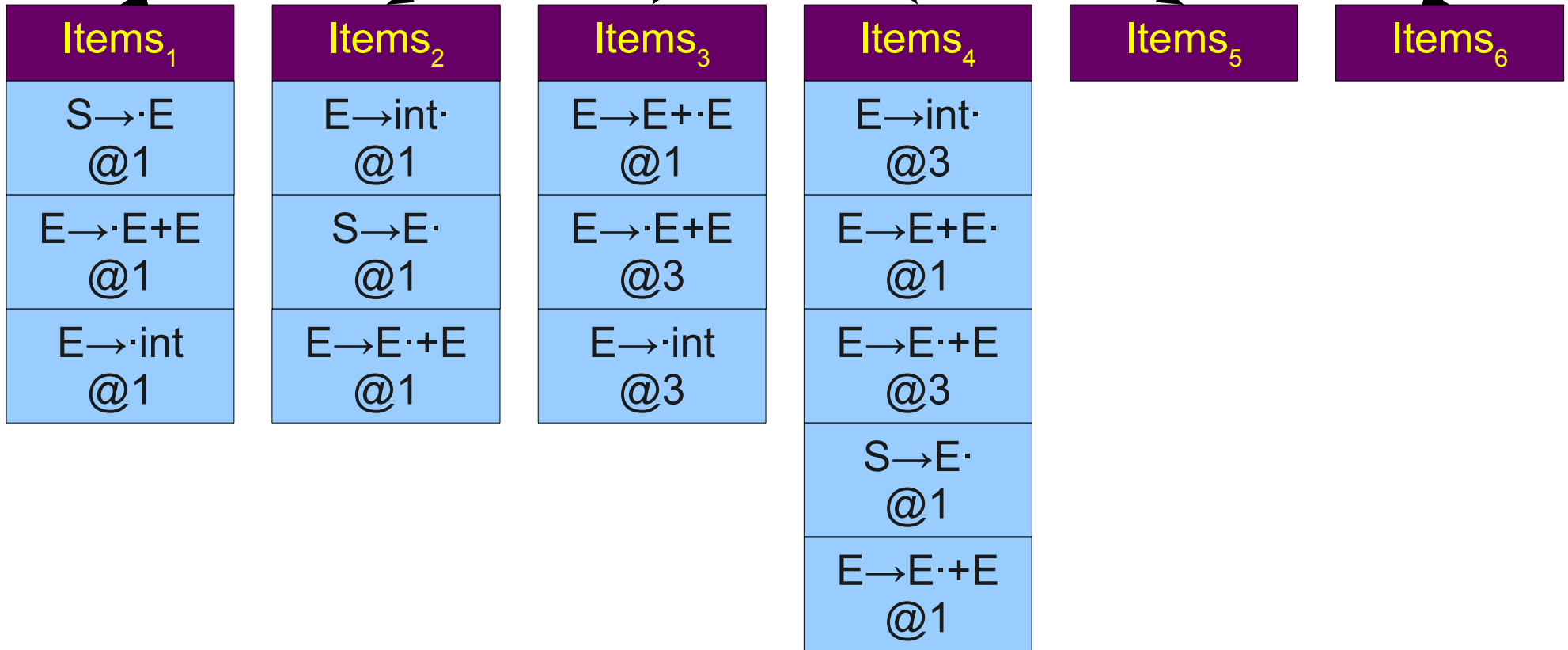

S → E
E → E + E
E → int

Earley in Action



int + int + int

Items₁

$S \rightarrow \cdot E$ @1
$E \rightarrow \cdot E + E$ @1
$E \rightarrow \cdot \text{int}$ @1

Items₂

$E \rightarrow \text{int} \cdot$ @1
$S \rightarrow E \cdot$ @1
$E \rightarrow E \cdot + E$ @1

Items₃

$E \rightarrow E + \cdot E$ @1
$E \rightarrow \cdot E + E$ @3
$E \rightarrow \cdot \text{int}$ @3

Items₄

$E \rightarrow \text{int} \cdot$ @3
$E \rightarrow E + E \cdot$ @1
$E \rightarrow E \cdot + E$ @3
$S \rightarrow E \cdot$ @1
$E \rightarrow E \cdot + E$ @1

Items₅

Items₆

$S \rightarrow E$
 $E \rightarrow E + E$
 $E \rightarrow \text{int}$

Earley in Action

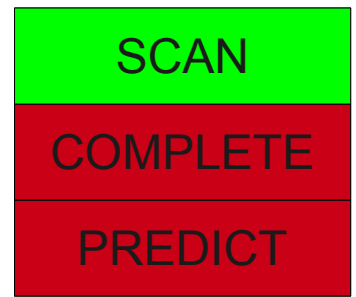

int + int + int

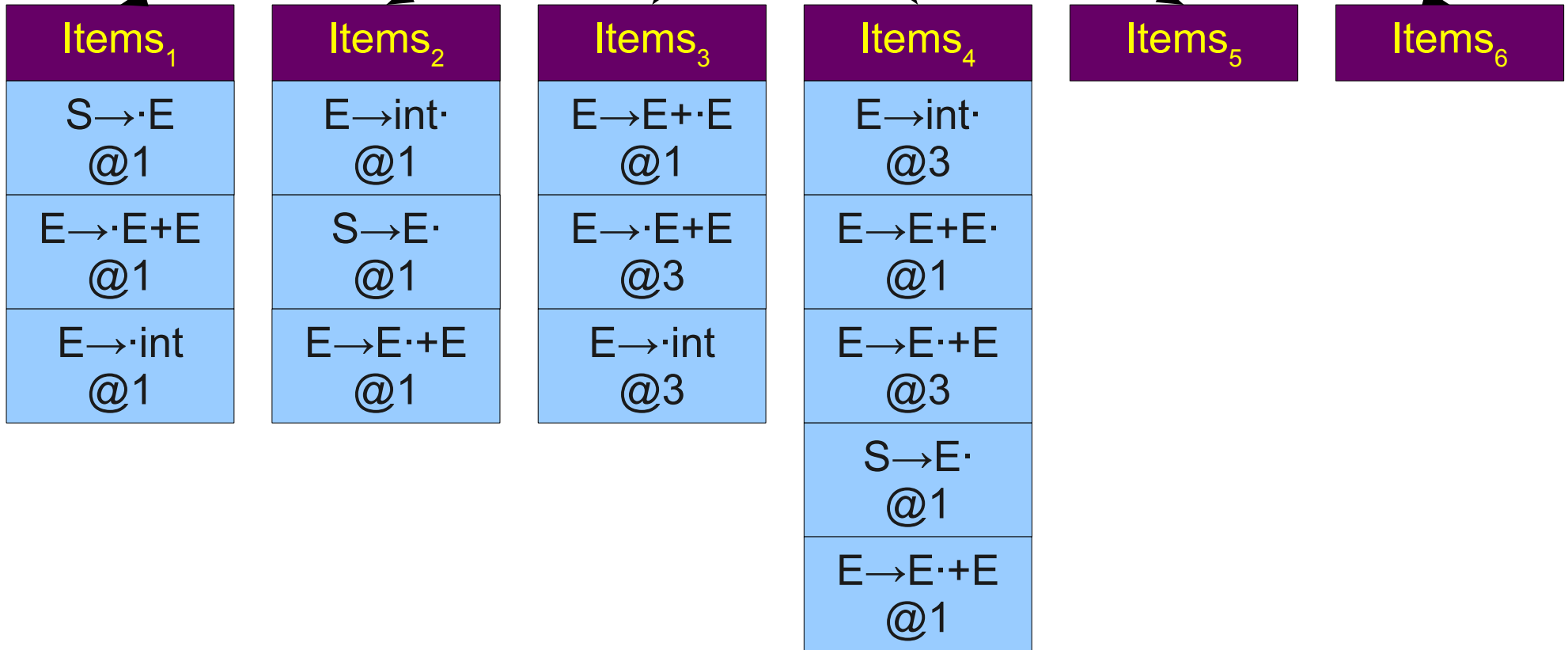

S → E
 E → E + E
 E → int

Earley in Action

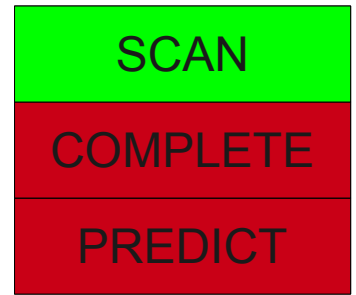

int + int + int

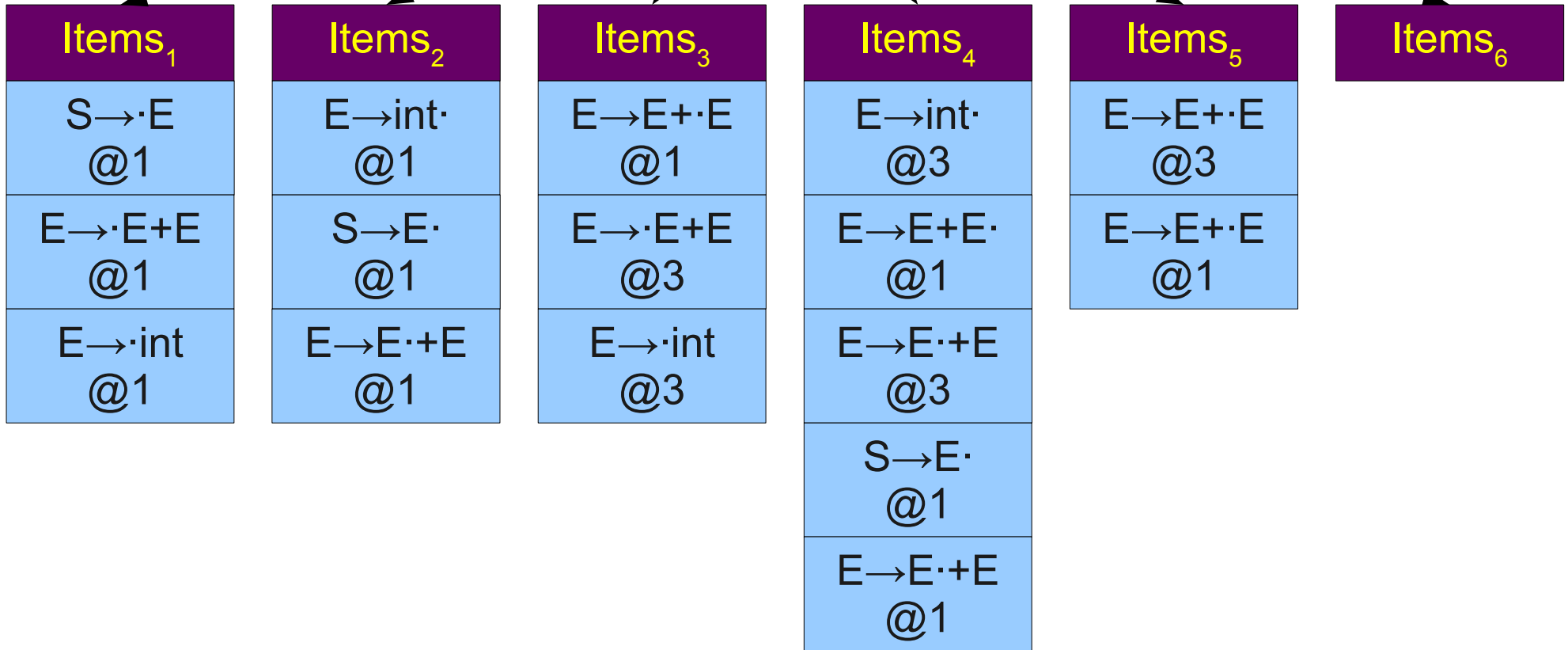

$S \rightarrow E$
 $E \rightarrow E + E$
 $E \rightarrow int$

Earley in Action

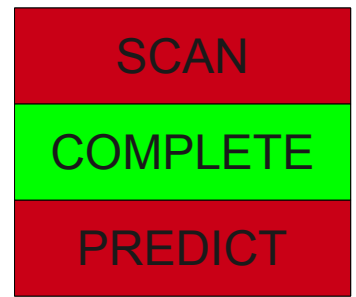

int + int + int

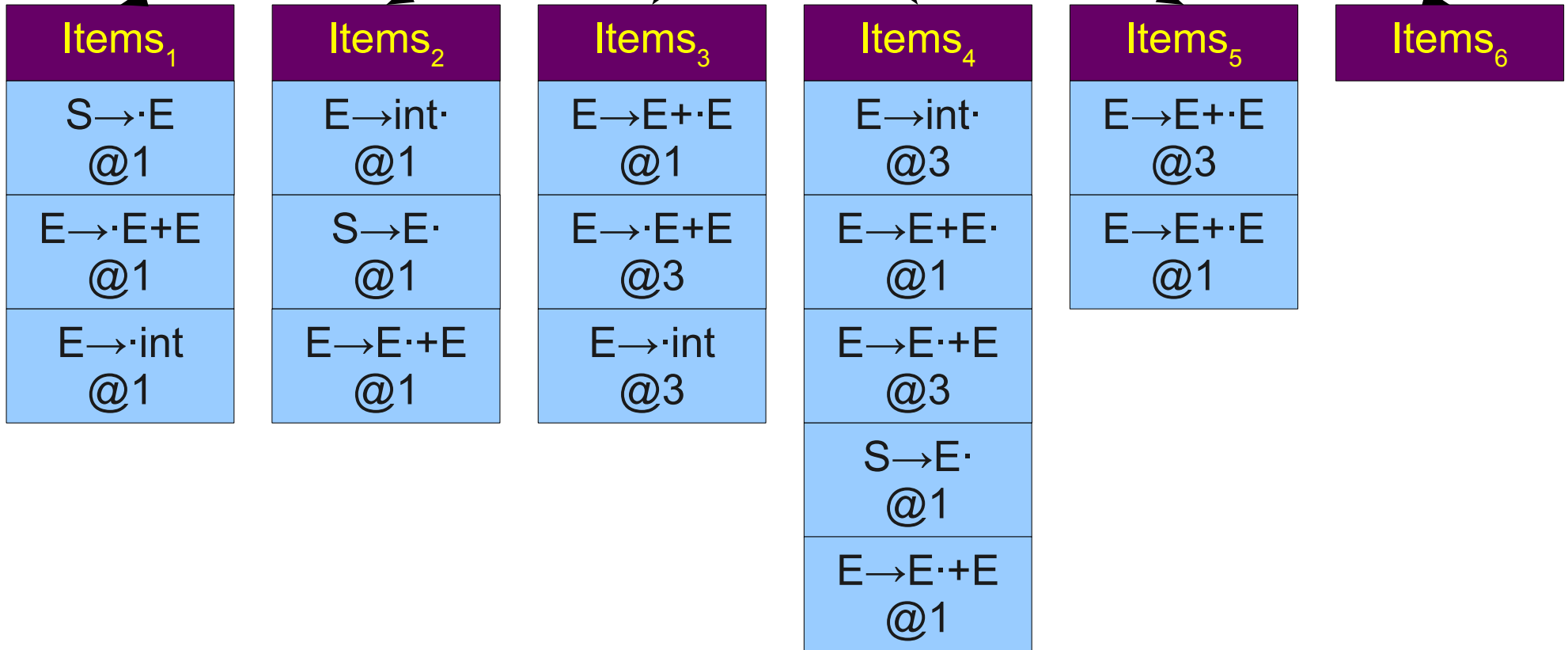

$S \rightarrow E$
 $E \rightarrow E + E$
 $E \rightarrow \text{int}$

Earley in Action

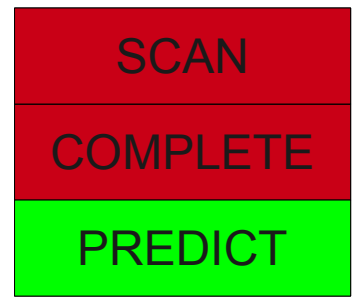

int + int + int

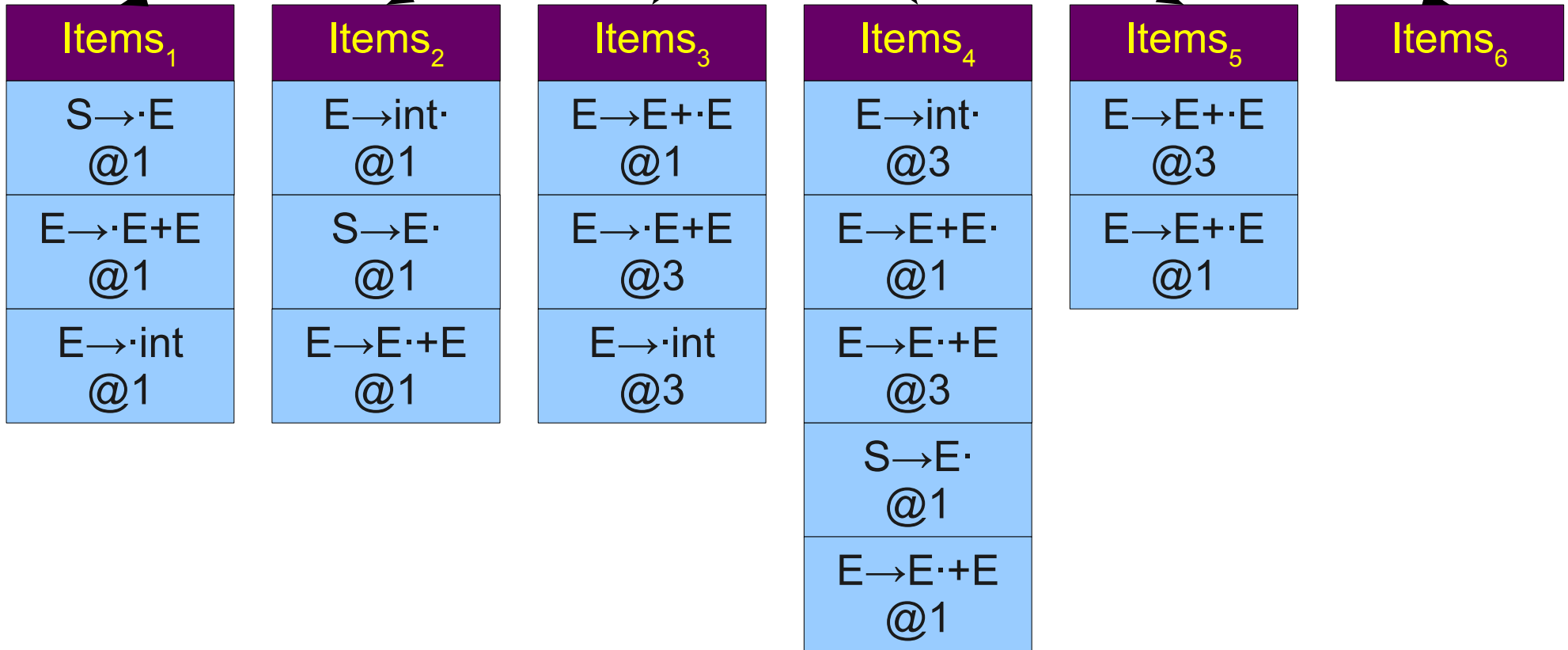

$S \rightarrow E$
 $E \rightarrow E + E$
 $E \rightarrow int$

Earley in Action

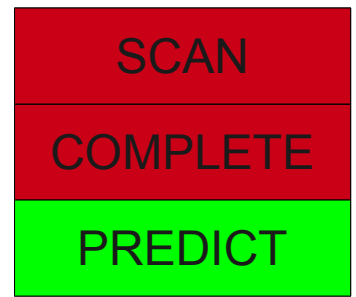

int + int + int

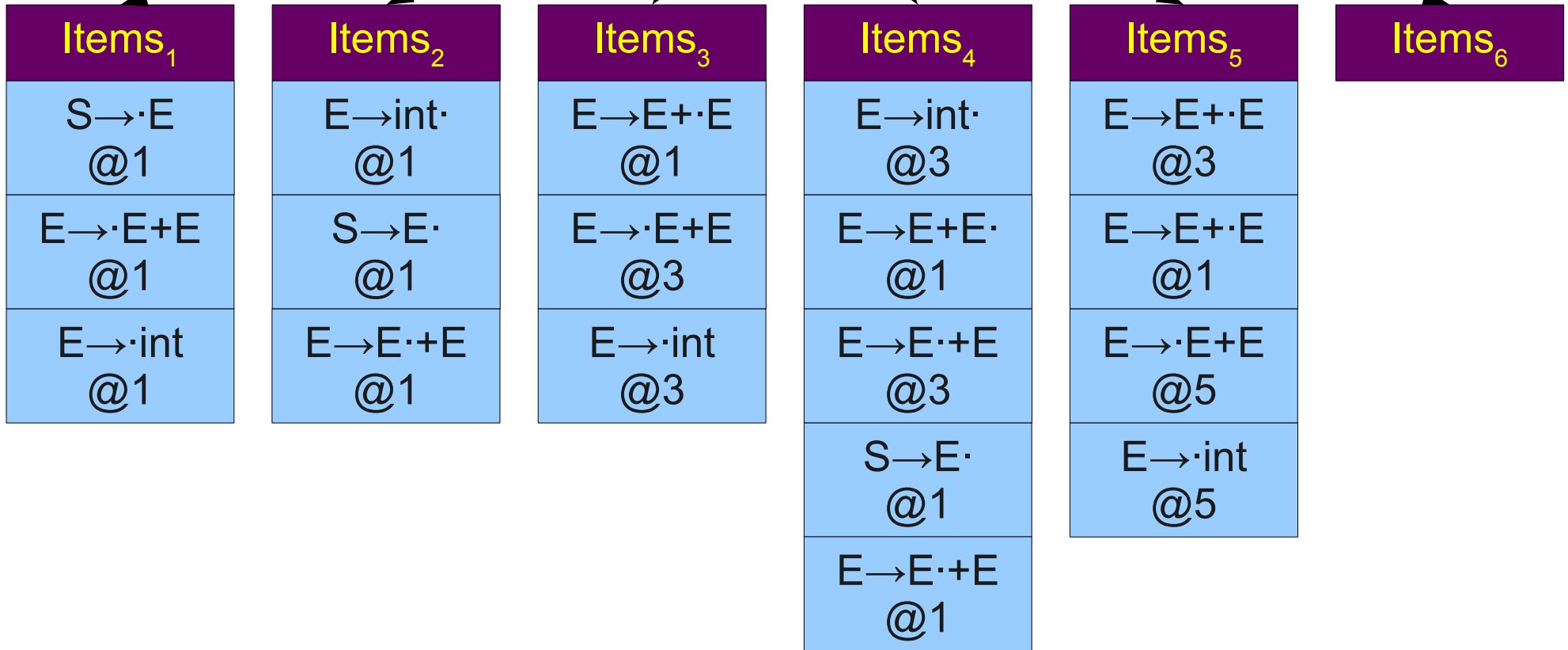

$S \rightarrow E$
 $E \rightarrow E + E$
 $E \rightarrow \text{int}$

Earley in Action

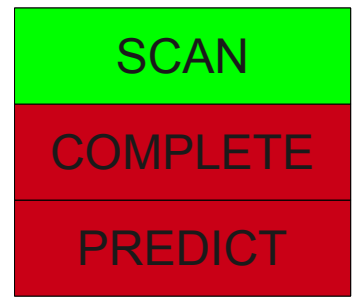

int + int + int

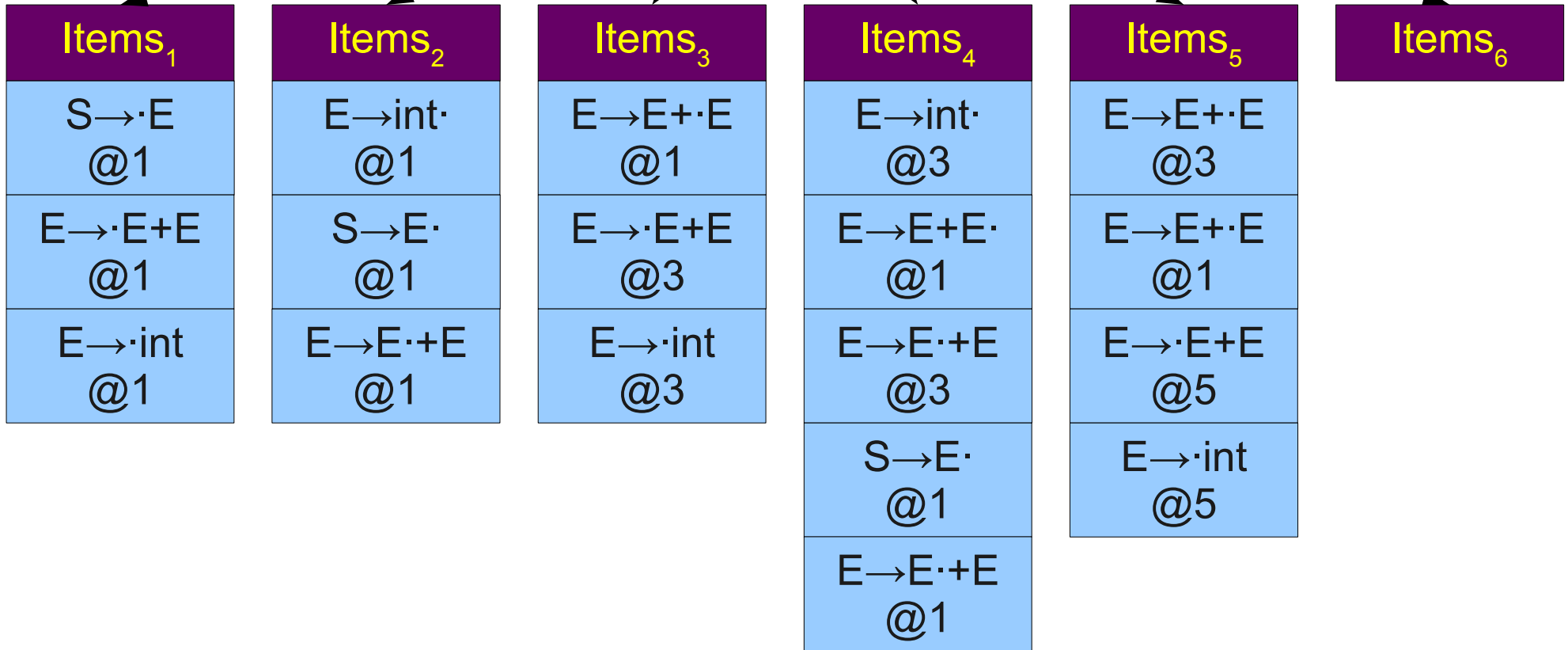

$S \rightarrow E$
 $E \rightarrow E + E$
 $E \rightarrow int$

Earley in Action

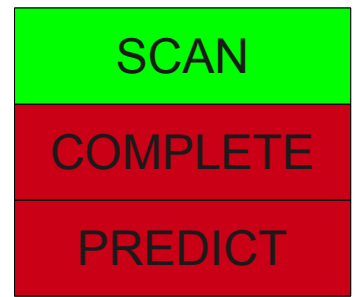

int + int + int

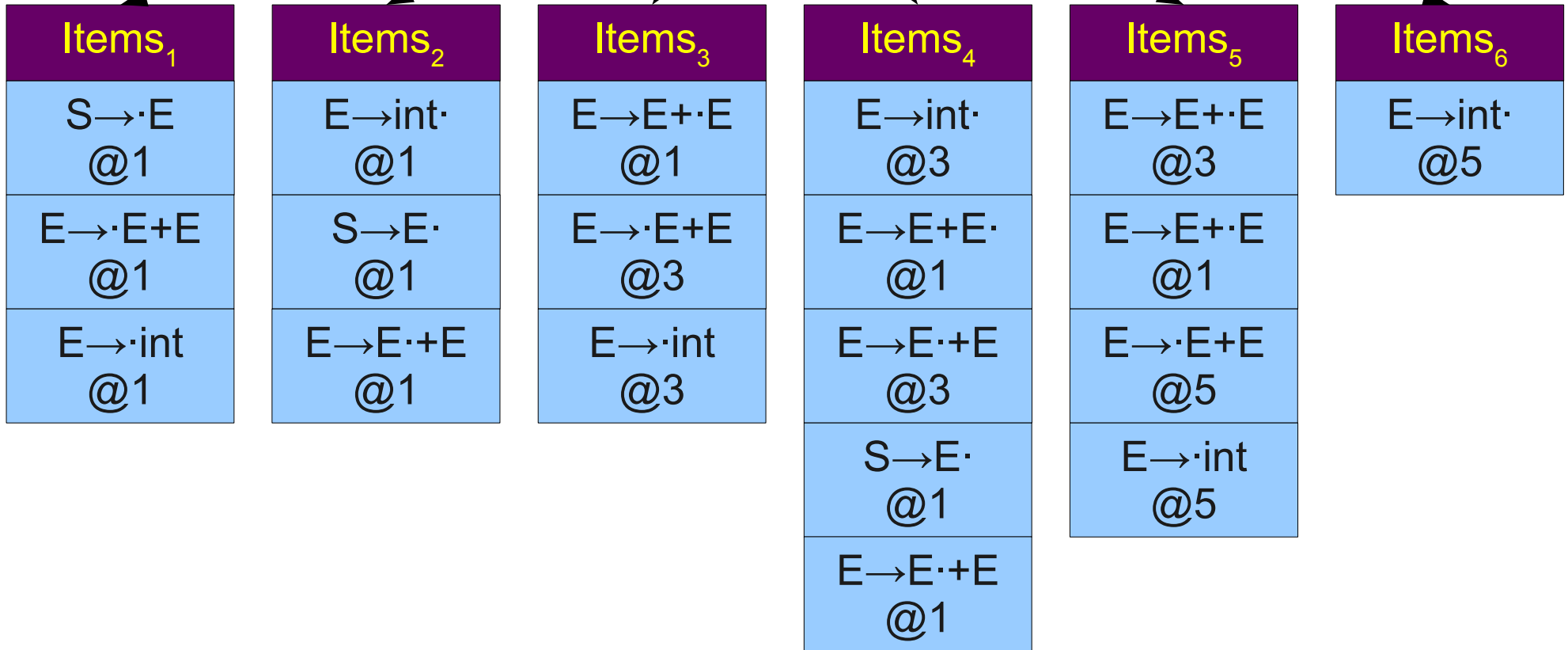

S → E
E → E + E
E → int

Earley in Action

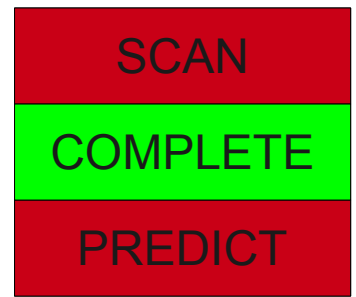

int + int + int

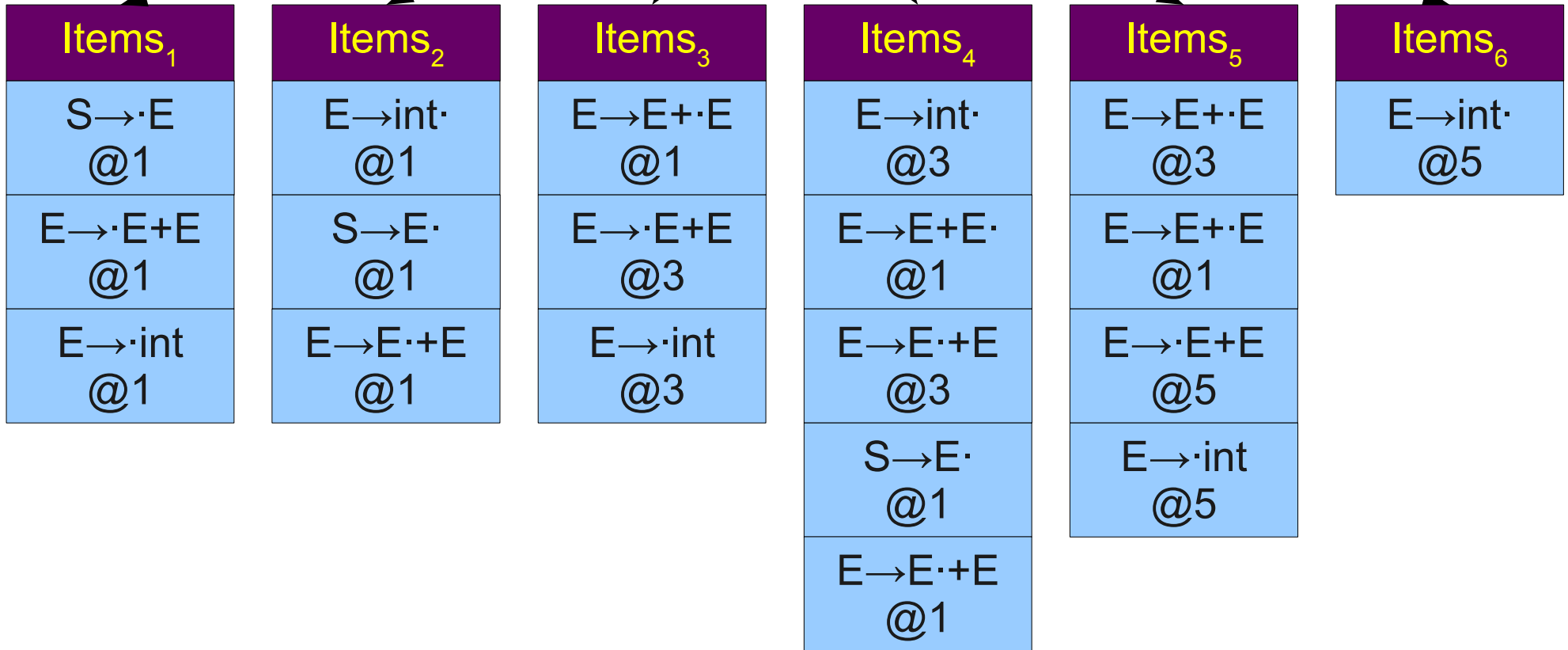

$S \rightarrow E$
 $E \rightarrow E + E$
 $E \rightarrow \text{int}$

Earley in Action

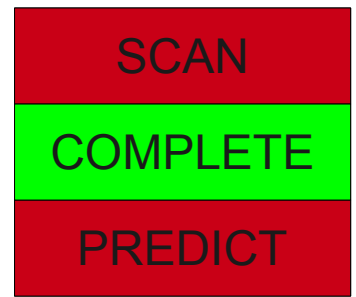

int + int + int

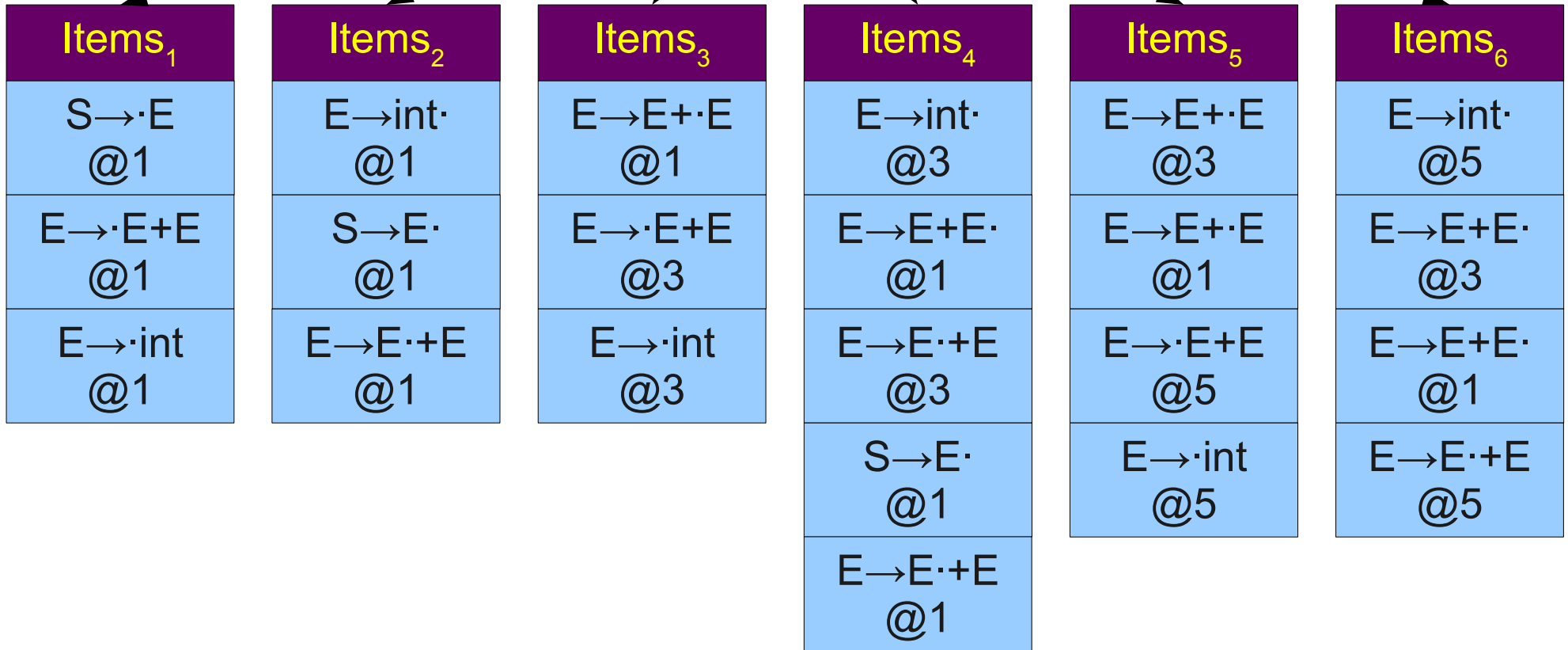

S → E
E → E + E
E → int

Earley in Action

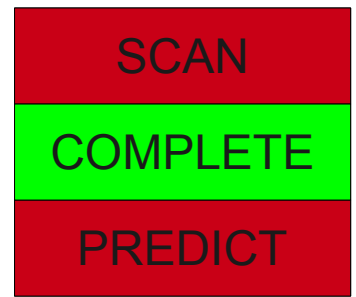

int + int + int

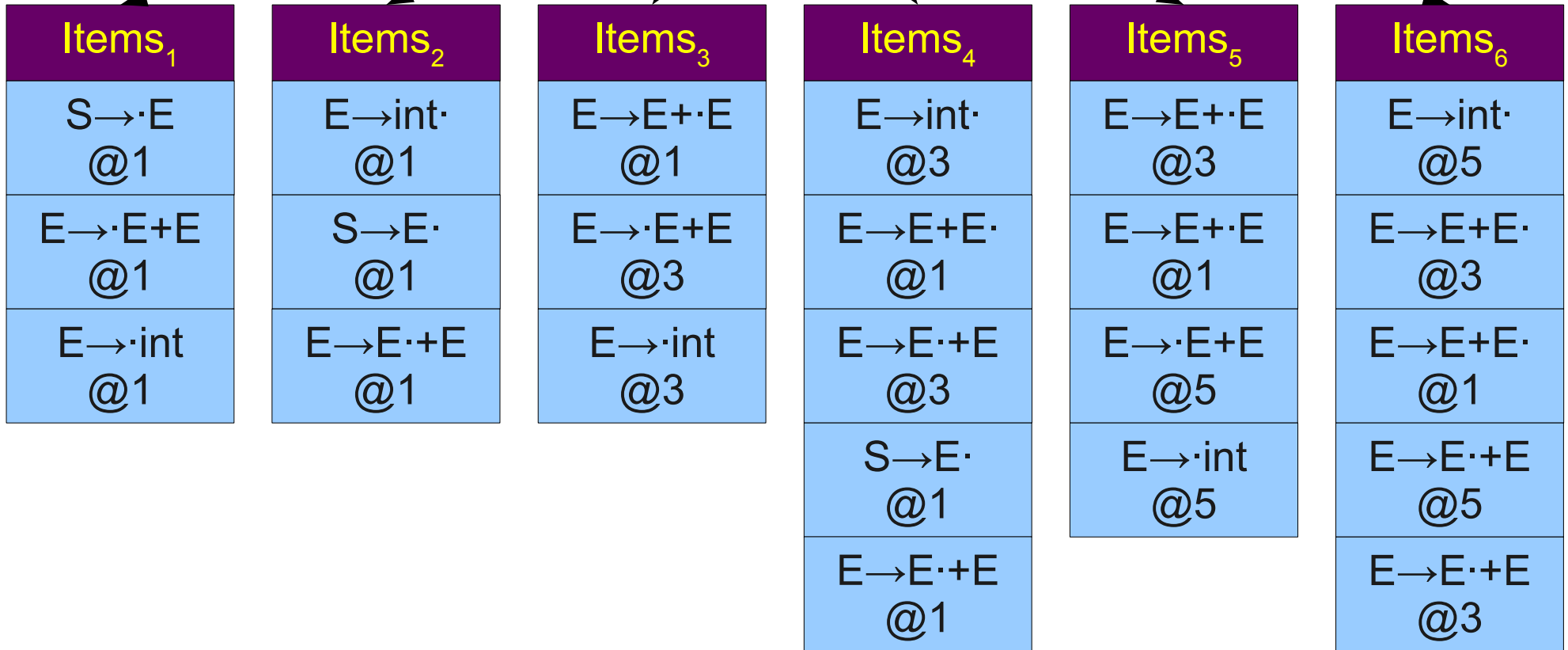

S → E
E → E + E
E → int

Earley in Action

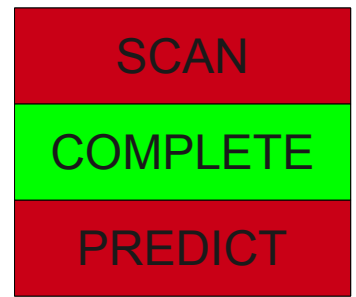

int + int + int

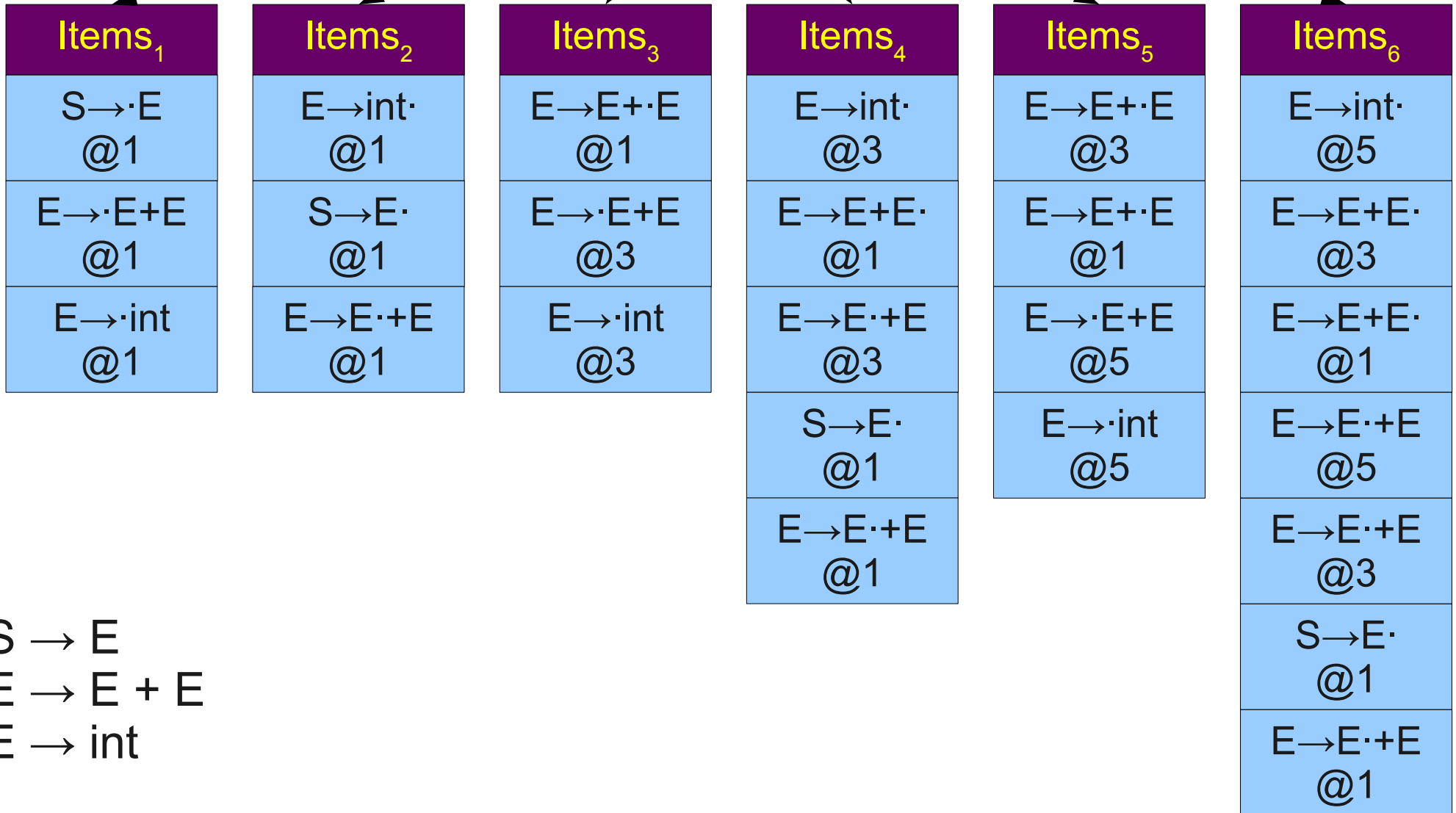

S → E
E → E + E
E → int

Earley in Action

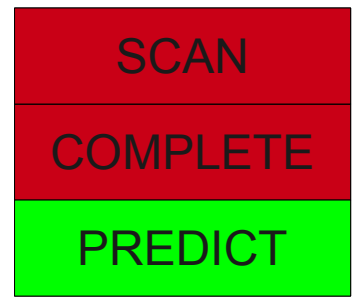

int + int + int

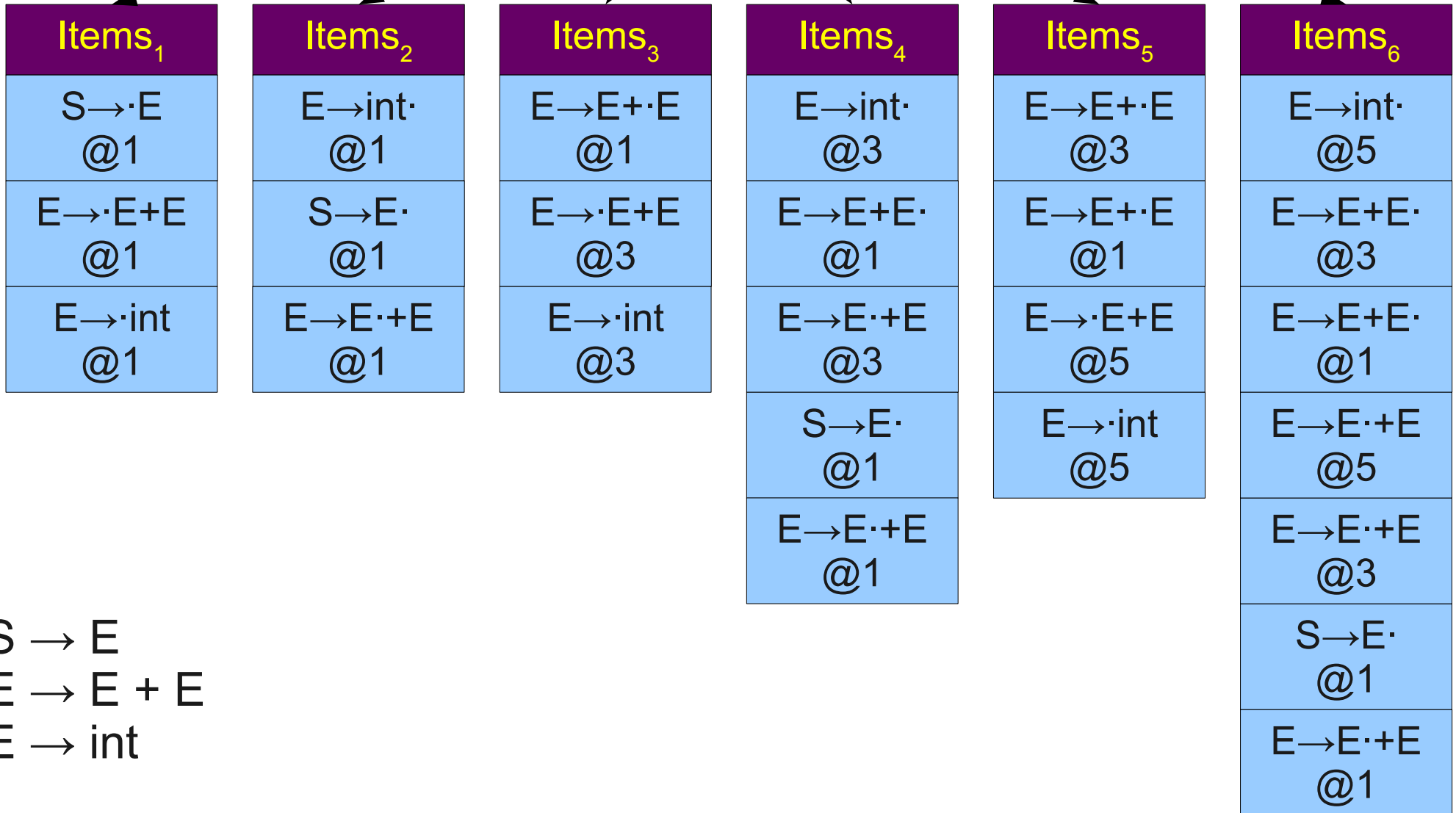

Earley in Action

SCAN
COMPLETE
PREDICT

int + int + int

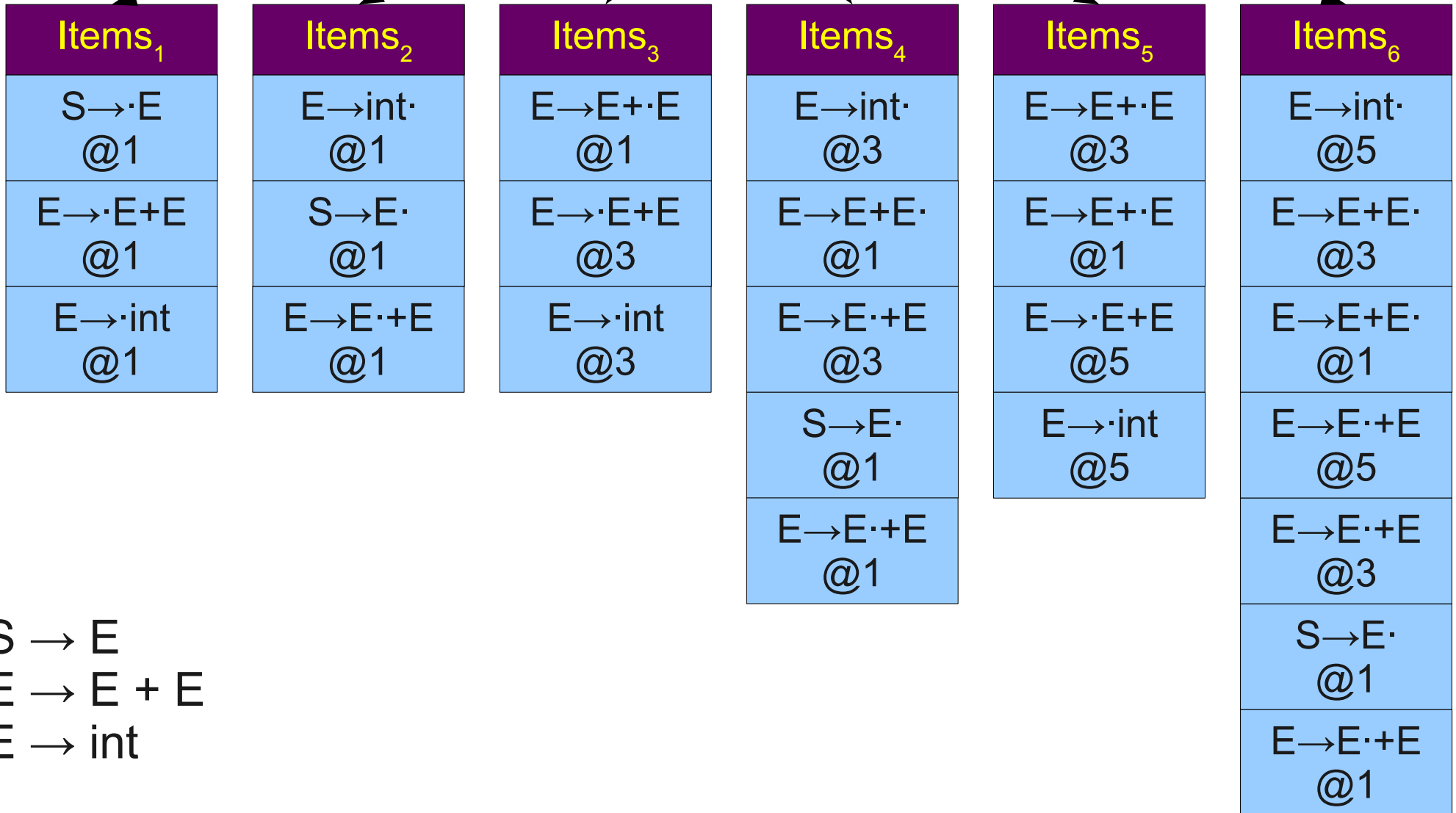

Earley in Action

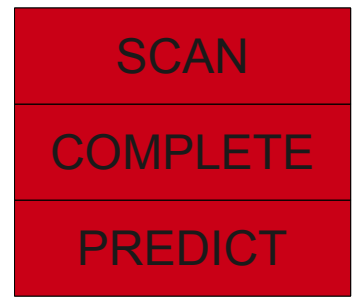

int + int + int

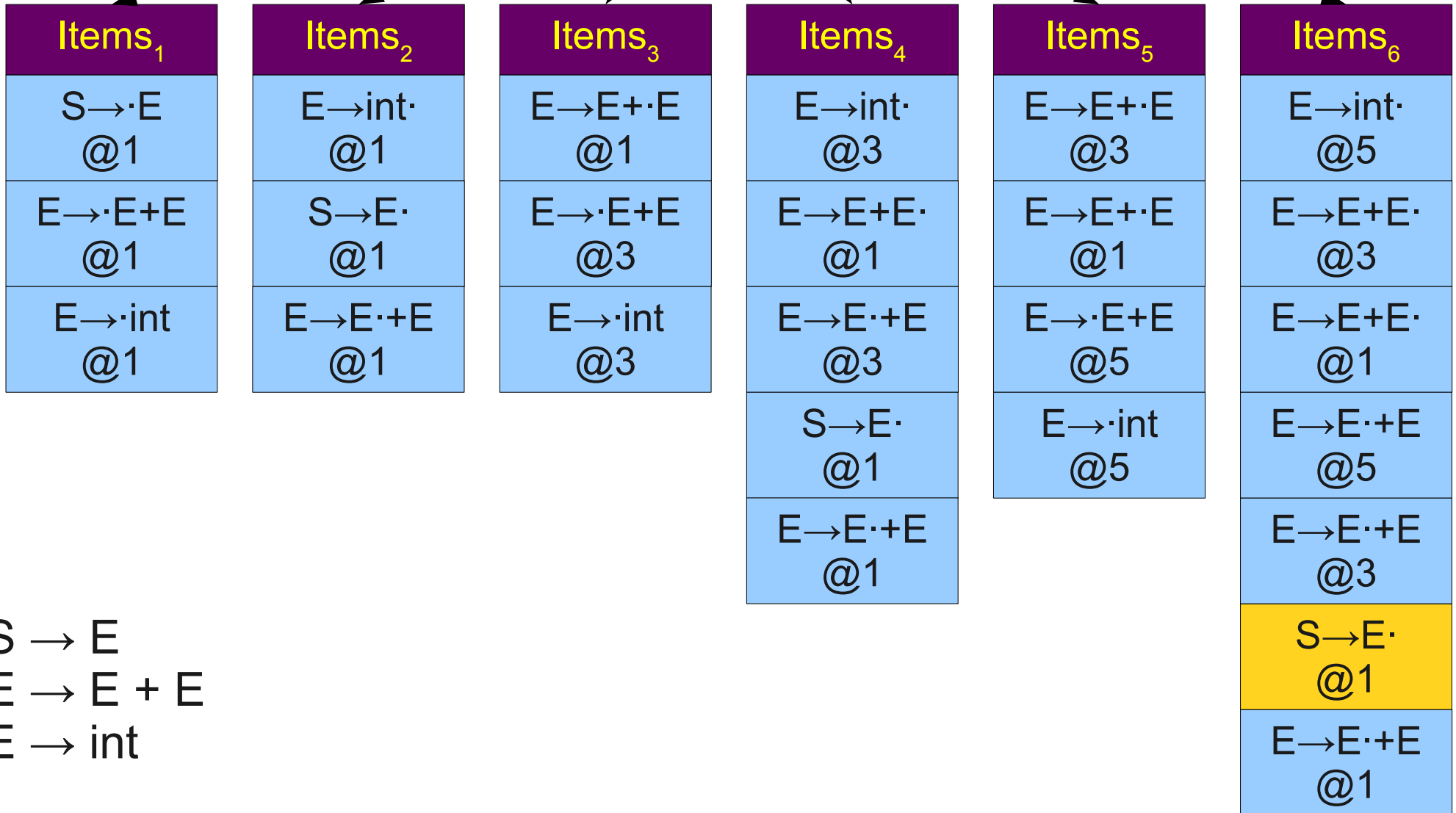

The Earley Algorithm

- **Assume no ϵ -rules.**
- Begin with the item $S \rightarrow \cdot E @1$ in the first item set.
- Cycle through the following rules for $k = 1 \dots |S| + 1$:
- Apply a **predict** step:
 - For each item $A \rightarrow u \cdot Bv @n$ in the k th item set, add the item $B \rightarrow \cdot w @k$ to the k th item set for each production $B \rightarrow w$.
- Apply a **scan** step:
 - For each item $A \rightarrow u \cdot tv @n$ in the k th item set, if the k th token is t , add $A \rightarrow ut \cdot v @n$ to the $(k + 1)$ st item set.
- Apply a **complete** step:
 - For each item $A \rightarrow u \cdot @n$ in the k th item set, for each item $B \rightarrow w \cdot Av @m$ in the n th item set, add $B \rightarrow wA \cdot v @m$ to the k th item set.

Supporting ϵ -Rules

- Simple modification to the **predict** step:
If there is an item $A \rightarrow u \cdot Bv @n$ in the k th item set, **where $B \rightarrow^* \epsilon$** , add the item $A \rightarrow uB \cdot v @n$ to the k th item set.
- Intuition: One prediction is that B ends up expanding out to nothing.

The Efficiency of Earley

- How many LR(0) items are possible in a grammar G ?
 - One for each possible position in any production.
 - $O(|G|)$
- How many Earley items can there be?
 - One for each triple of (LR(0) item, start position, end position).
 - $O(|G|n^2)$
- How many times can each item be generated?
 - Item at position k could be added from positions $1, 2, \dots, k - 1$
 - $O(n)$
- Overall complexity is **$O(|G|n^3)$**
- For a fixed grammar, parse time is **$O(n^3)$** .
- Memory usage always **$O(n^2)$** .

Interesting Results

- The Earley parser always runs in $O(n^2)$ on **unambiguous grammars**.
 - Intuition: Never generates the same item twice.
- If we add k tokens of lookahead before applying productions or reductions, the Earley parser can parse any $LR(k)$ grammar in $O(n)$.
 - Intuition: We never need to backtrack, so each item generated ends up being used.

Recognizers and Parsers

- We have just discussed the Earley **recognizer**, not the Earley **parser**.
- Right now, we can only detect whether a string is valid by seeing if $S \rightarrow E \cdot @1$ is in the last item set.
- We need to discuss how to upgrade our **recognizer** into a **parser**.
- If the grammar is ambiguous, how do we hand back multiple parse trees?

A Highly Ambiguous Grammar

$X \rightarrow XX$

$X \rightarrow a$

A Highly Ambiguous Grammar

$X \rightarrow XX$

$X \rightarrow a$

a	a	a	a	a	a
---	---	---	---	---	---

A Highly Ambiguous Grammar

$X \rightarrow XX$

$X \rightarrow a$

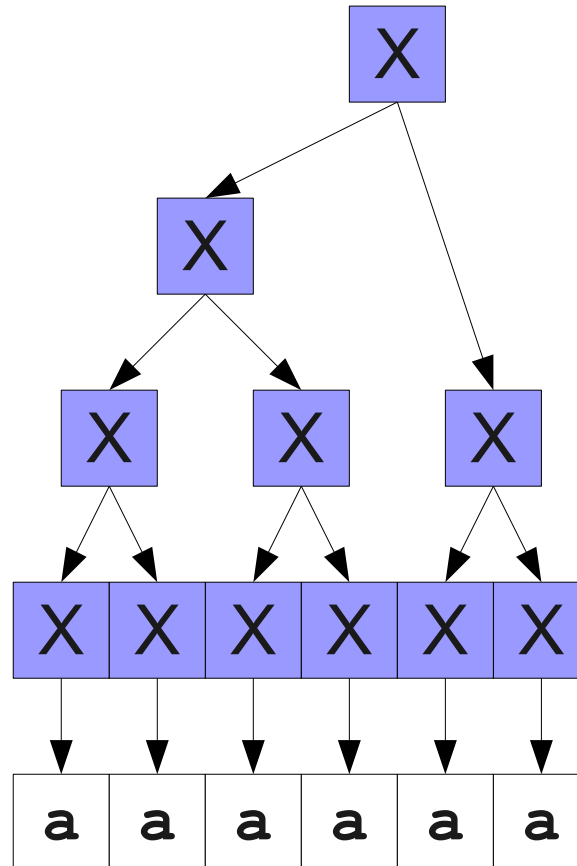

A Highly Ambiguous Grammar

$X \rightarrow XX$

$X \rightarrow a$

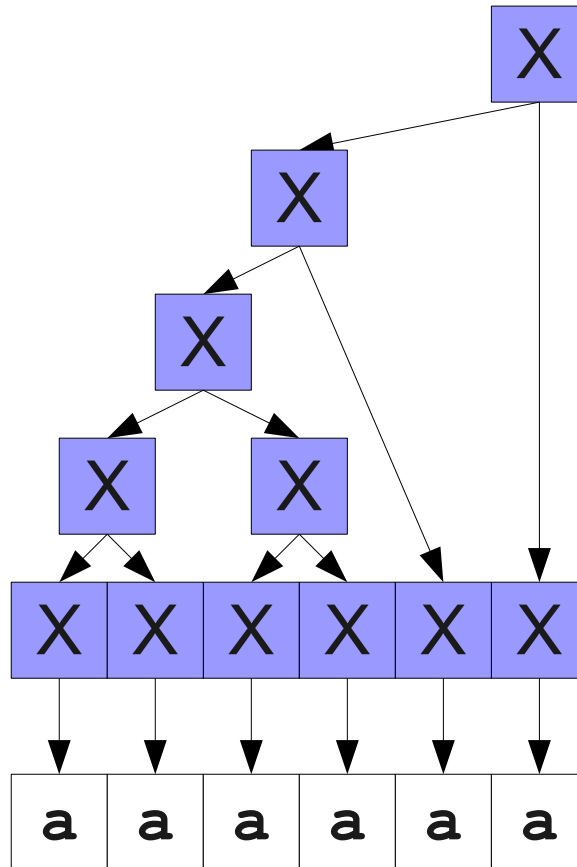

An Infinitely Ambiguous Grammar

$X \rightarrow X$

$X \rightarrow a$

An Infinitely Ambiguous Grammar

$X \rightarrow X$

$X \rightarrow a$

a

An Infinitely Ambiguous Grammar

$X \rightarrow X$

$X \rightarrow a$

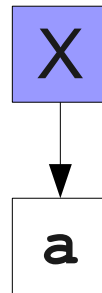

An Infinitely Ambiguous Grammar

$X \rightarrow X$

$X \rightarrow a$

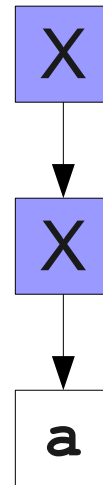

An Infinitely Ambiguous Grammar

$X \rightarrow X$

$X \rightarrow a$

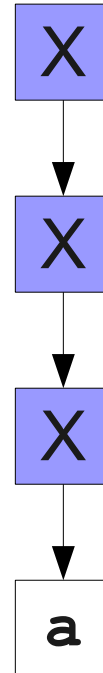

Given that there can be **infinitely many parse trees**, how could we possibly list all of them?

CHALLENGE ACCEPTED

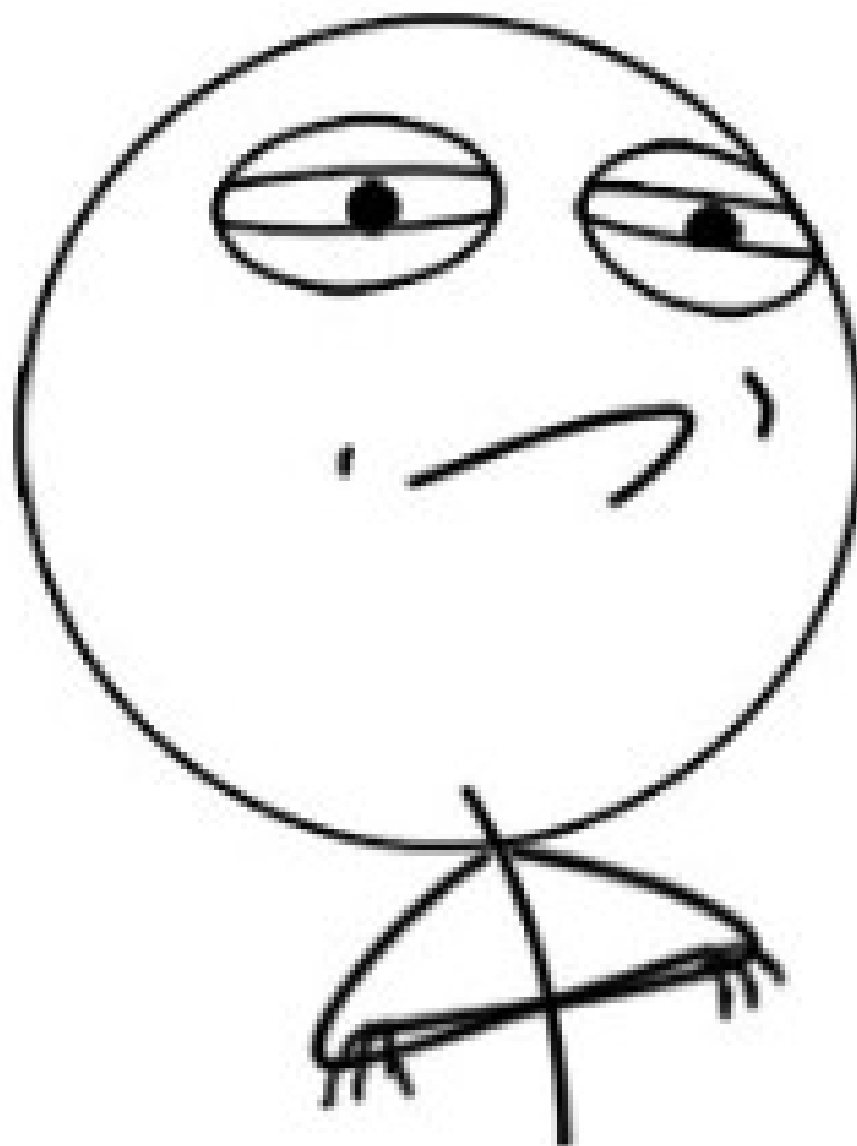

$E \rightarrow T$
 $E \rightarrow T + E$
 $T \rightarrow \text{int}$
 $T \rightarrow (E)$

A Simple Parse Tree

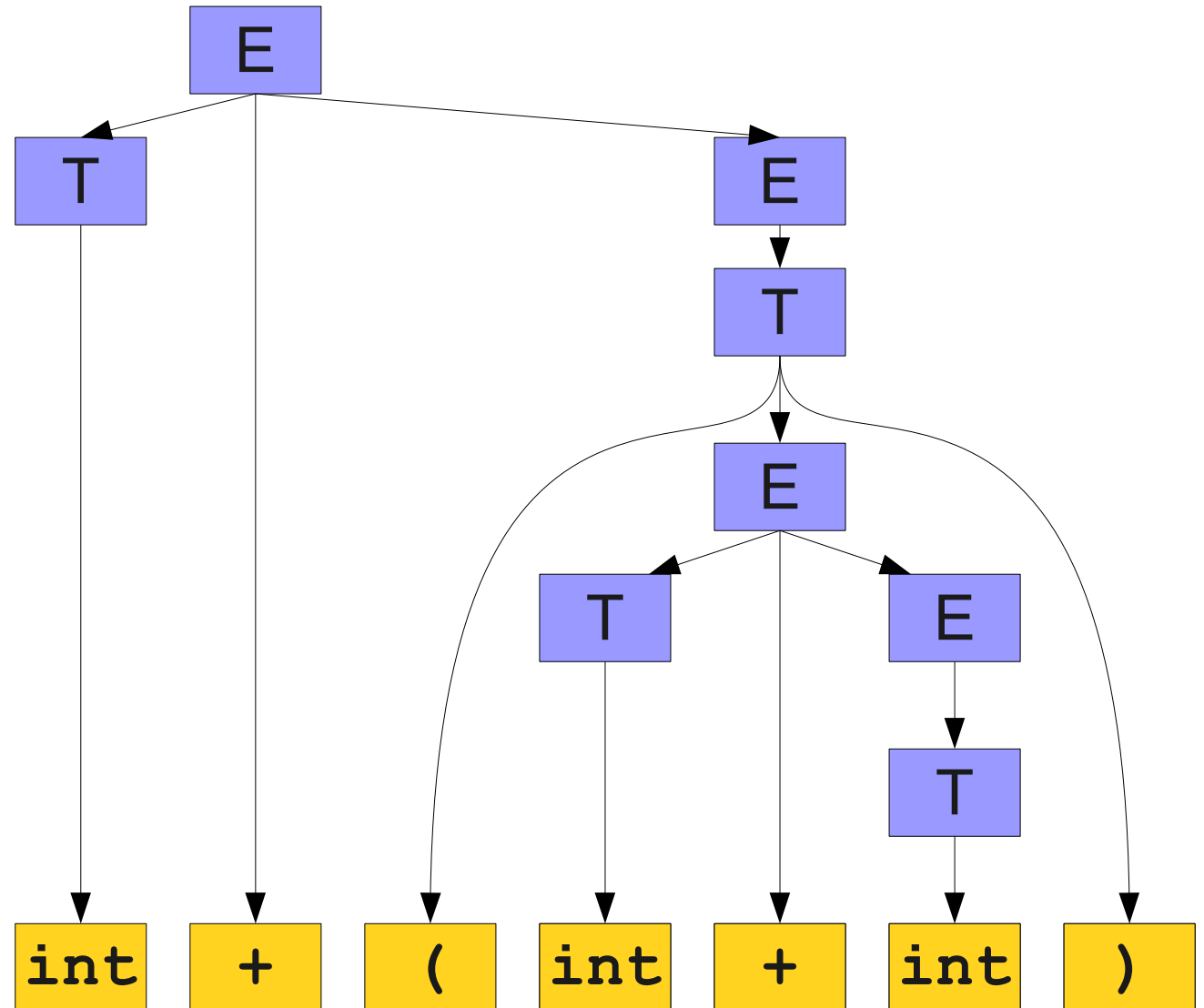

$E \rightarrow T$
 $E \rightarrow T + E$
 $T \rightarrow \text{int}$
 $T \rightarrow (E)$

A Simple Parse Tree

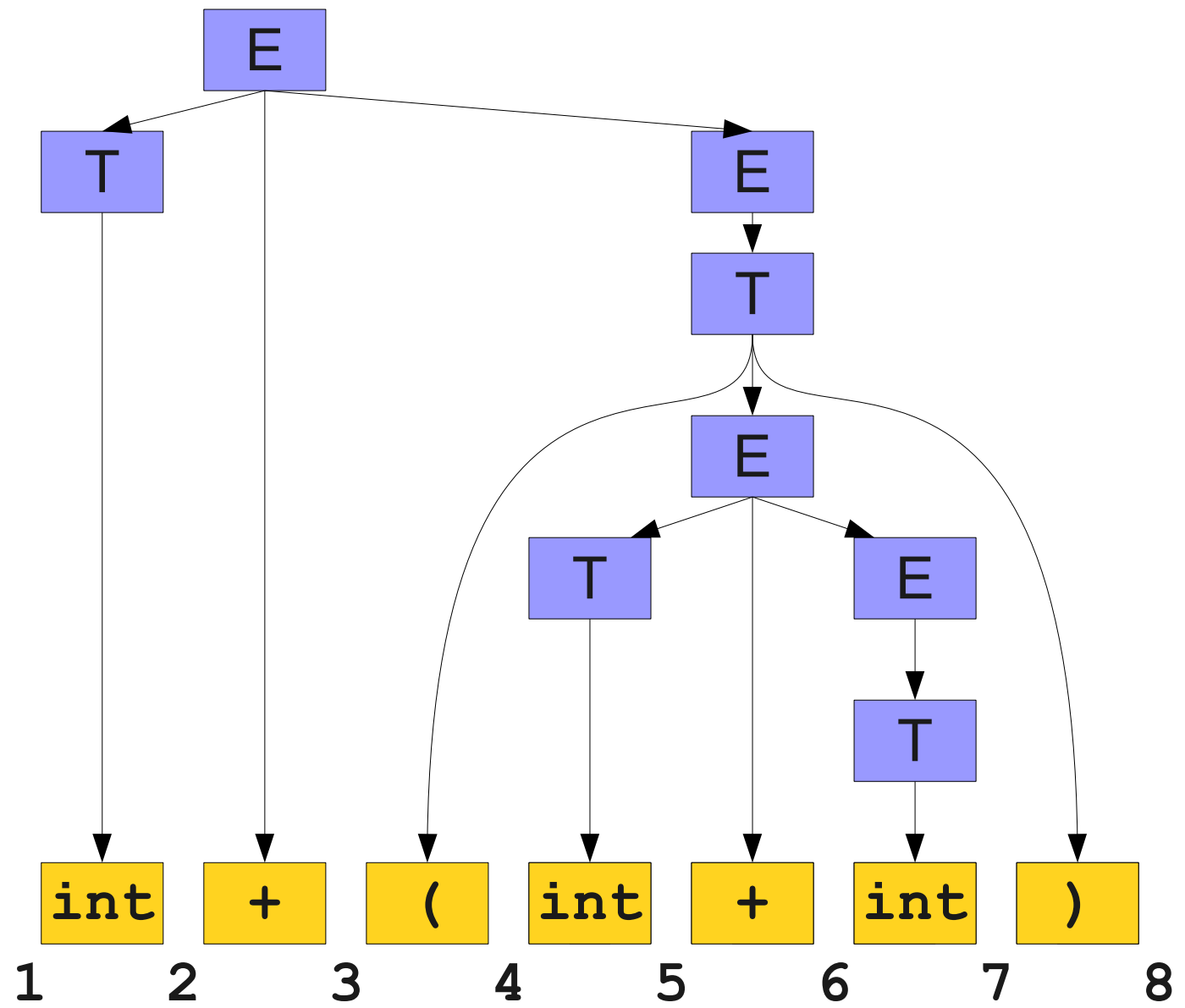

$E \rightarrow T$
 $E \rightarrow T + E$
 $T \rightarrow \text{int}$
 $T \rightarrow (E)$

$S \rightarrow E_{1-8}$

A Simple Parse Tree

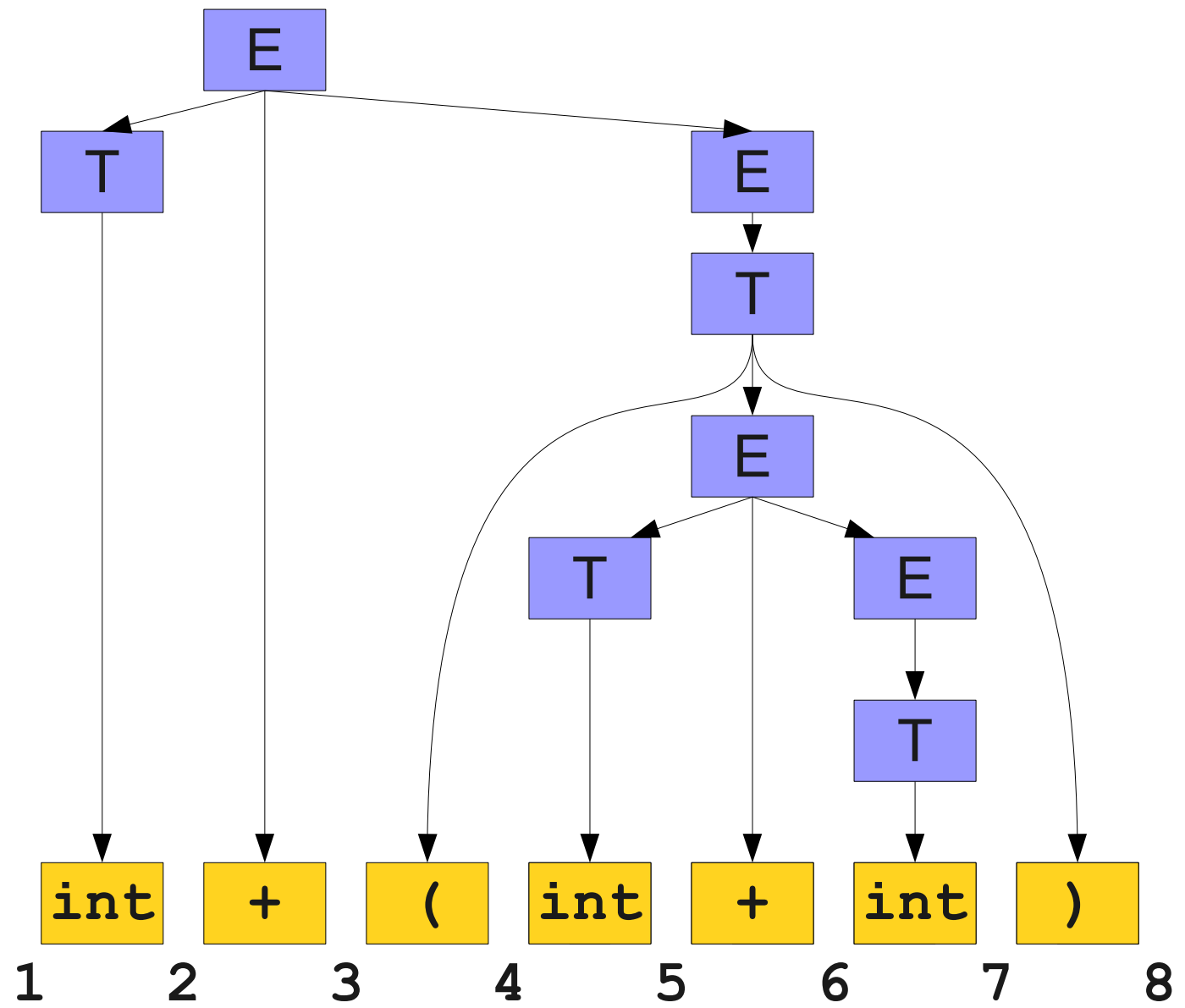

$E \rightarrow T$
 $E \rightarrow T + E$
 $T \rightarrow \text{int}$
 $T \rightarrow (E)$

A Simple Parse Tree

$S \rightarrow E_{1-8}$
 $E_{1-8} \rightarrow T_{1-2} +_{2-3} E_{3-8}$

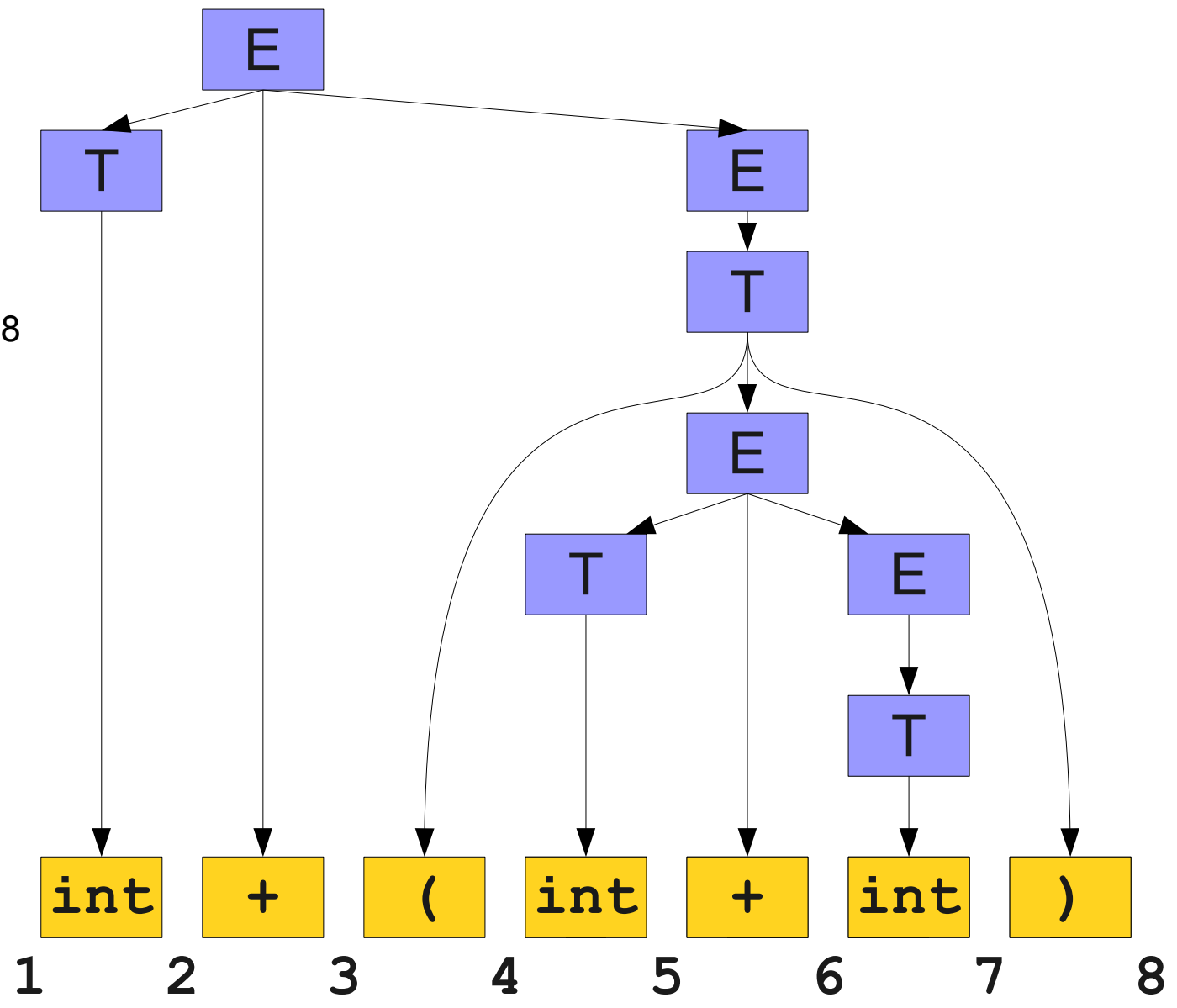

$E \rightarrow T$
 $E \rightarrow T + E$
 $T \rightarrow \text{int}$
 $T \rightarrow (E)$

A Simple Parse Tree

$S \rightarrow E_{1-8}$
 $E_{1-8} \rightarrow T_{1-2} +_{2-3} E_{3-8}$
 $T_{1-2} \rightarrow \text{int}_{1-2}$

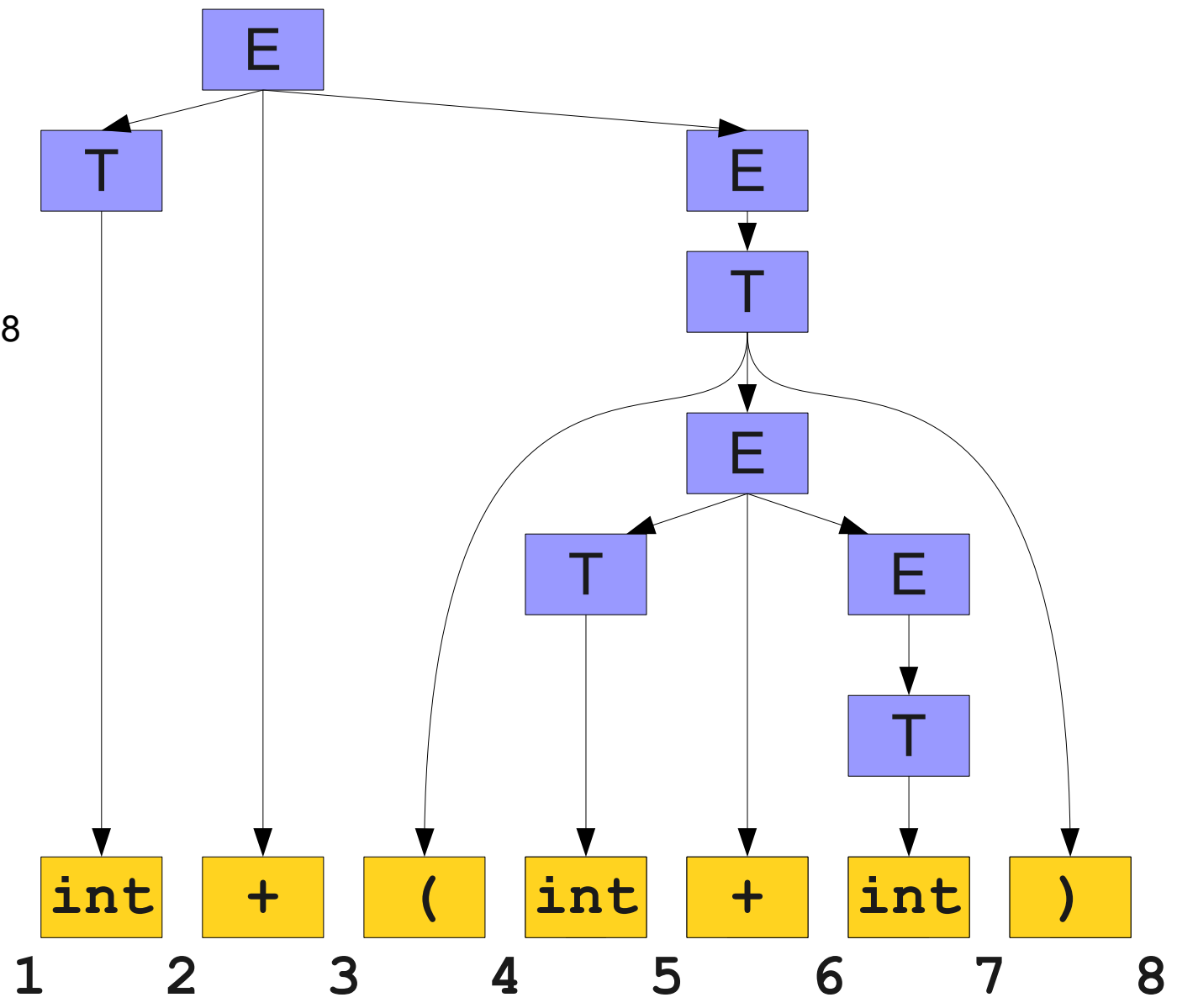

$E \rightarrow T$
 $E \rightarrow T + E$
 $T \rightarrow \text{int}$
 $T \rightarrow (E)$

A Simple Parse Tree

$S \rightarrow E_{1-8}$
 $E_{1-8} \rightarrow T_{1-2} +_{2-3} E_{3-8}$
 $T_{1-2} \rightarrow \text{int}_{1-2}$
 $E_{3-8} \rightarrow T_{3-8}$

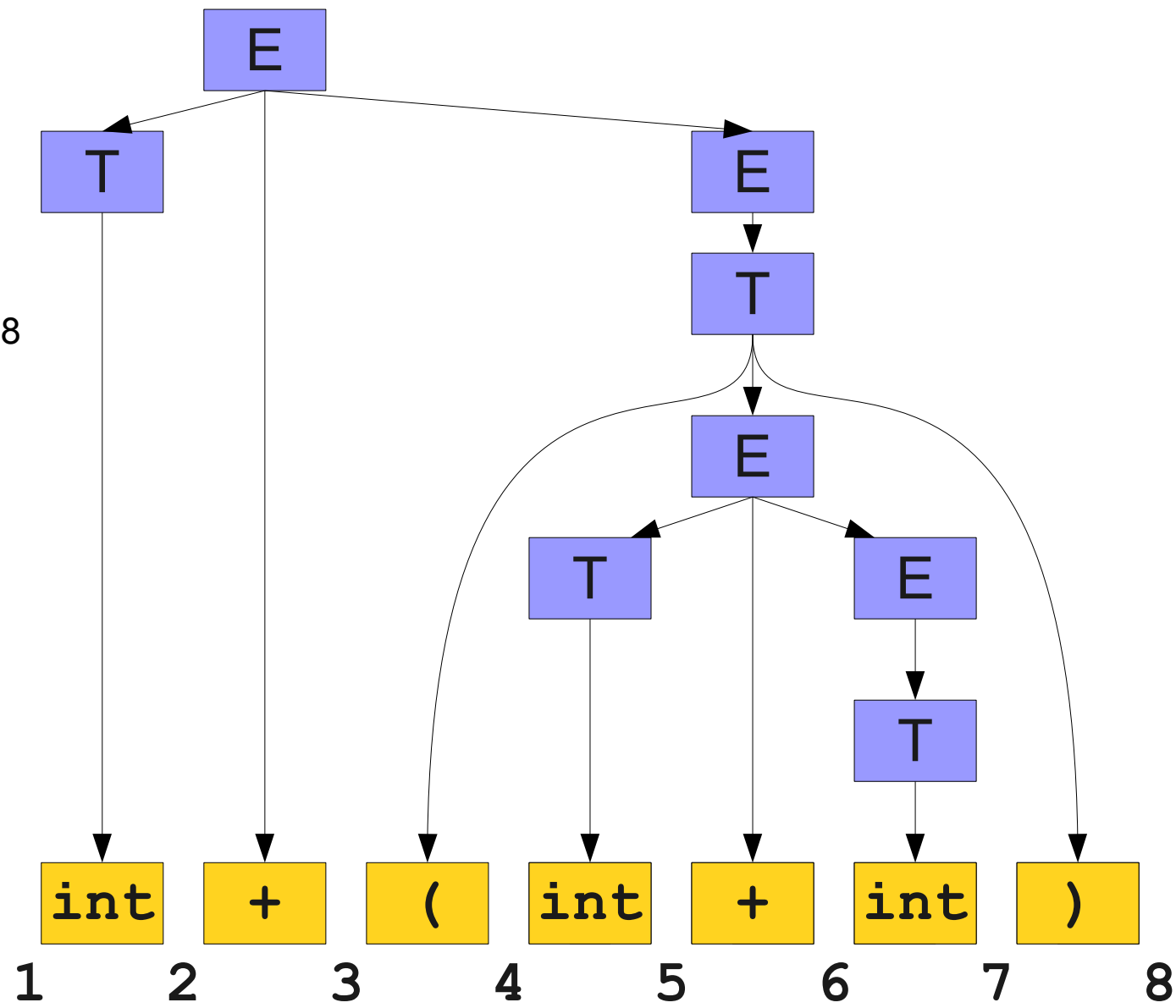

A Simple Parse Tree

$E \rightarrow T$
 $E \rightarrow T + E$
 $T \rightarrow \text{int}$
 $T \rightarrow (E)$

$S \rightarrow E_{1-8}$
 $E_{1-8} \rightarrow T_{1-2} +_{2-3} E_{3-8}$
 $T_{1-2} \rightarrow \text{int}_{1-2}$
 $E_{3-8} \rightarrow T_{3-8}$
 $T_{3-8} \rightarrow (_{3-4} E_{4-7})_{7-8}$

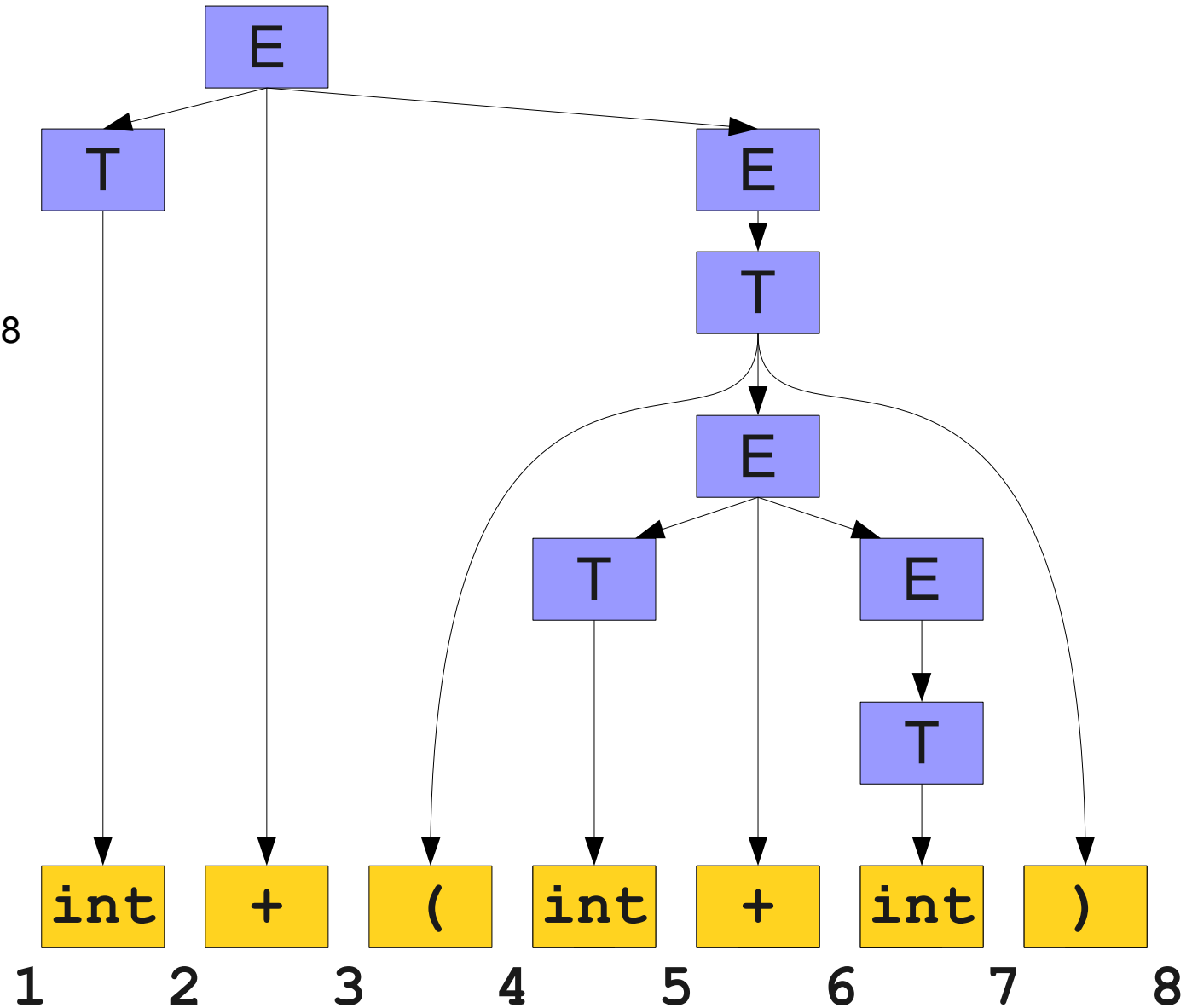

A Simple Parse Tree

$E \rightarrow T$
 $E \rightarrow T + E$
 $T \rightarrow \text{int}$
 $T \rightarrow (E)$

$S \rightarrow E_{1-8}$
 $E_{1-8} \rightarrow T_{1-2} +_{2-3} E_{3-8}$
 $T_{1-2} \rightarrow \text{int}_{1-2}$
 $E_{3-8} \rightarrow T_{3-8}$
 $T_{3-8} \rightarrow (_{3-4} E_{4-7})_{7-8}$
 $E_{4-7} \rightarrow T_{4-5} +_{5-6} E_{6-7}$

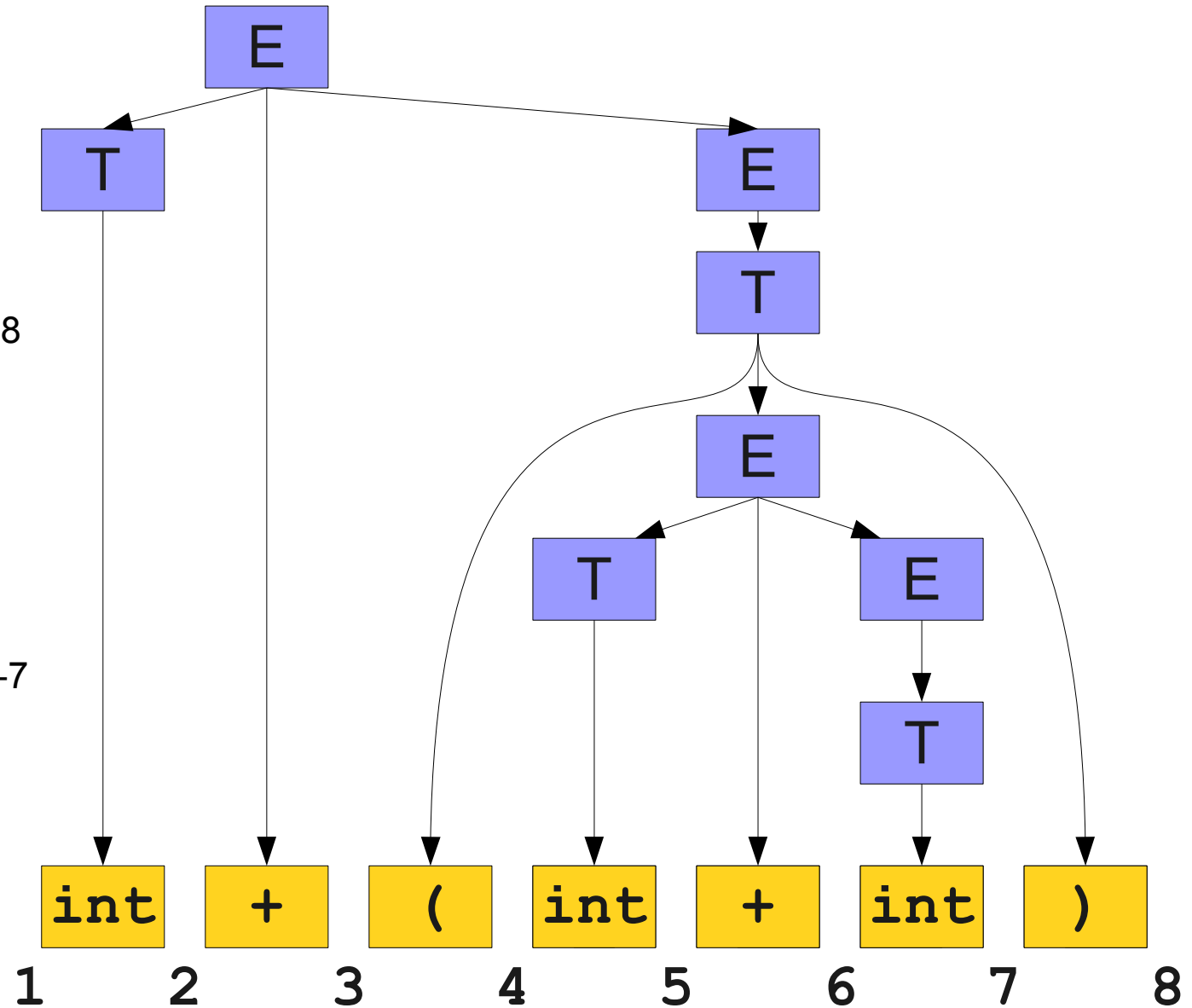

A Simple Parse Tree

$E \rightarrow T$
 $E \rightarrow T + E$
 $T \rightarrow \text{int}$
 $T \rightarrow (E)$

$S \rightarrow E_{1-8}$
 $E_{1-8} \rightarrow T_{1-2} +_{2-3} E_{3-8}$
 $T_{1-2} \rightarrow \text{int}_{1-2}$
 $E_{3-8} \rightarrow T_{3-8}$
 $T_{3-8} \rightarrow (_{3-4} E_{4-7})_{7-8}$
 $E_{4-7} \rightarrow T_{4-5} +_{5-6} E_{6-7}$
 $T_{4-5} \rightarrow \text{int}_{4-5}$

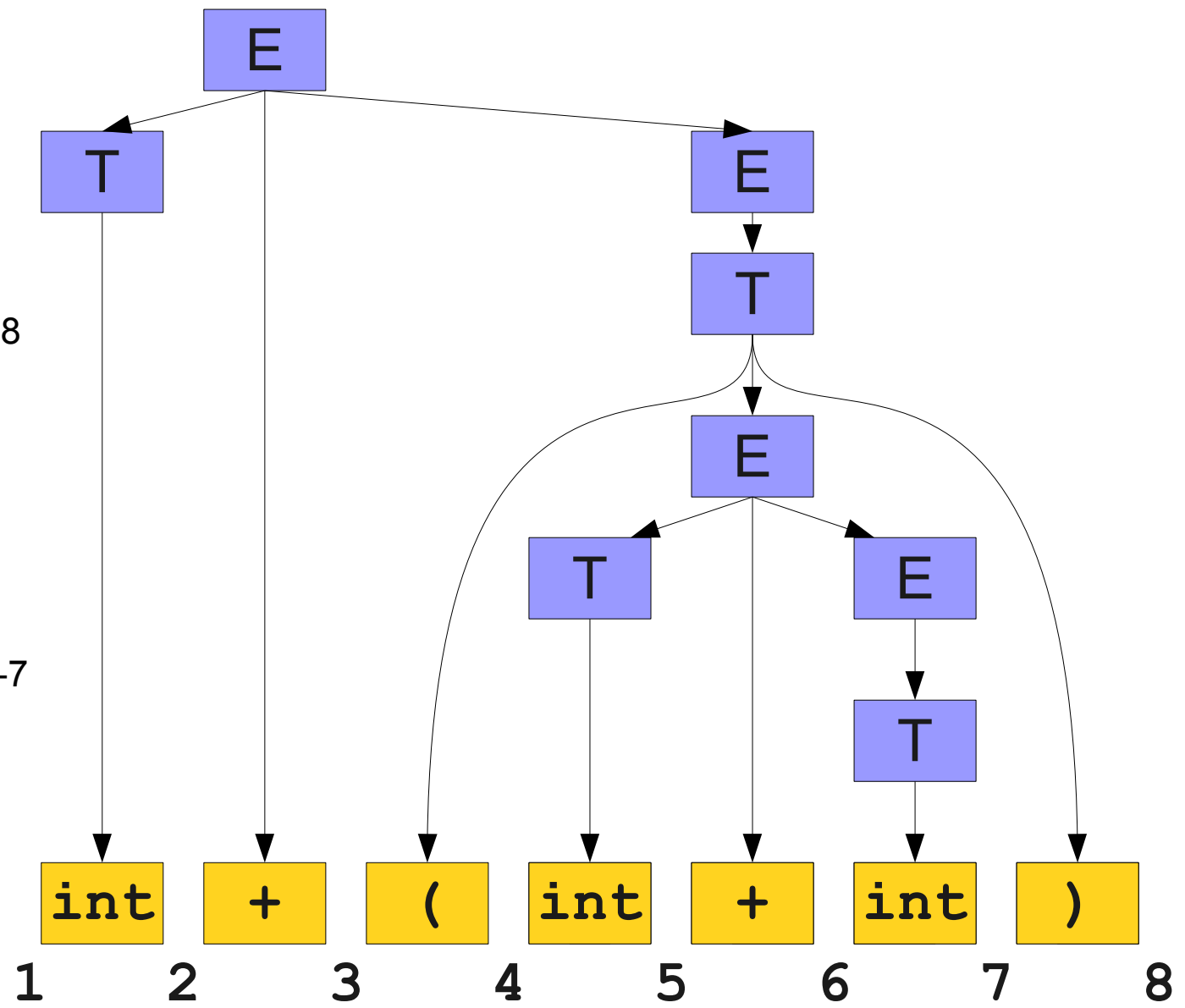

A Simple Parse Tree

$E \rightarrow T$
 $E \rightarrow T + E$
 $T \rightarrow \text{int}$
 $T \rightarrow (E)$

$S \rightarrow E_{1-8}$
 $E_{1-8} \rightarrow T_{1-2} +_{2-3} E_{3-8}$
 $T_{1-2} \rightarrow \text{int}_{1-2}$
 $E_{3-8} \rightarrow T_{3-8}$
 $T_{3-8} \rightarrow (_{3-4} E_{4-7})_{7-8}$
 $E_{4-7} \rightarrow T_{4-5} +_{5-6} E_{6-7}$
 $T_{4-5} \rightarrow \text{int}_{4-5}$
 $E_{6-7} \rightarrow T_{6-7}$

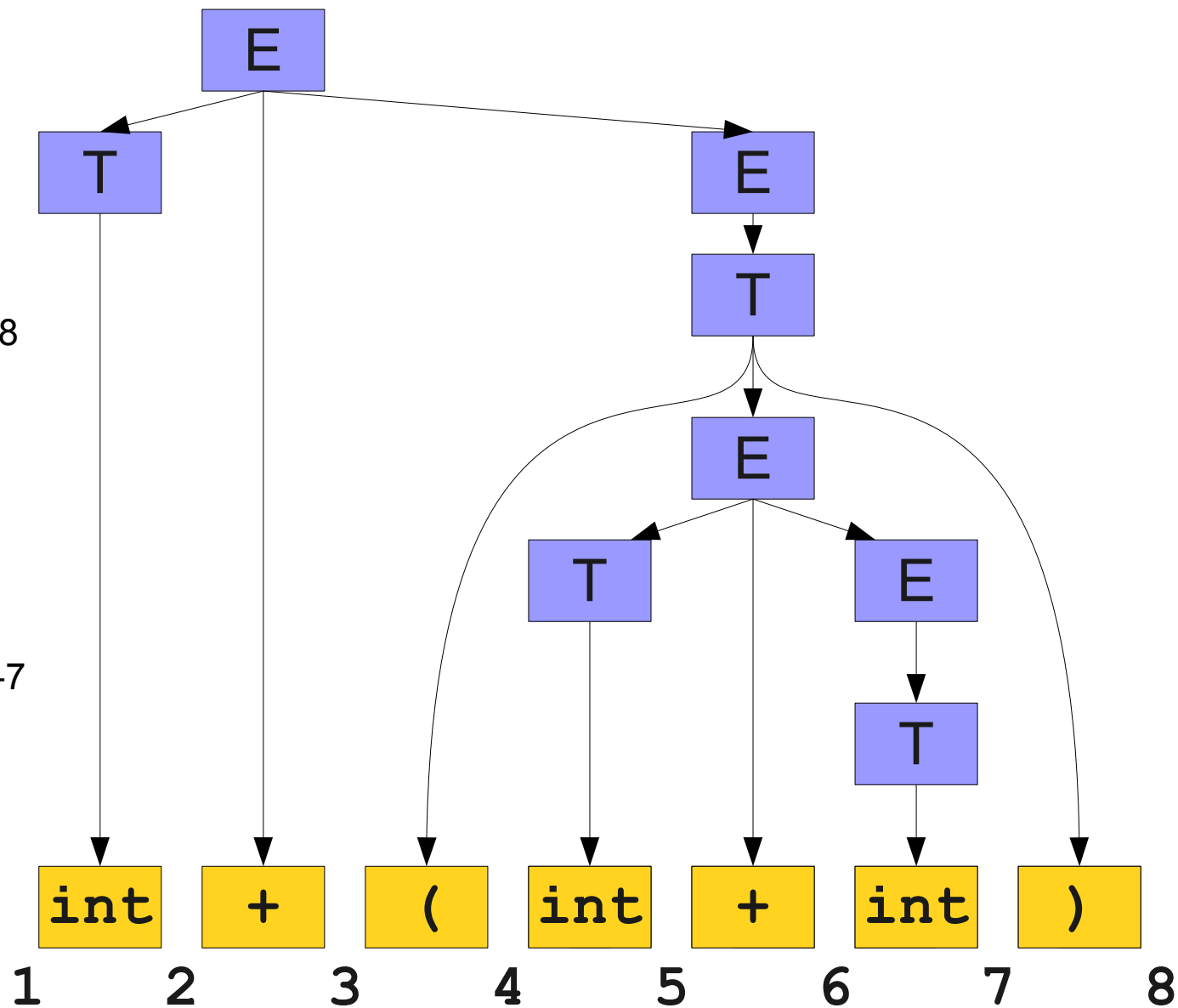

A Simple Parse Tree

$E \rightarrow T$
 $E \rightarrow T + E$
 $T \rightarrow \text{int}$
 $T \rightarrow (E)$

$S \rightarrow E_{1-8}$
 $E_{1-8} \rightarrow T_{1-2} +_{2-3} E_{3-8}$
 $T_{1-2} \rightarrow \text{int}_{1-2}$
 $E_{3-8} \rightarrow T_{3-8}$
 $T_{3-8} \rightarrow (_{3-4} E_{4-7})_{7-8}$
 $E_{4-7} \rightarrow T_{4-5} +_{5-6} E_{6-7}$
 $T_{4-5} \rightarrow \text{int}_{4-5}$
 $E_{6-7} \rightarrow T_{6-7}$
 $T_{6-7} \rightarrow \text{int}_{6-7}$

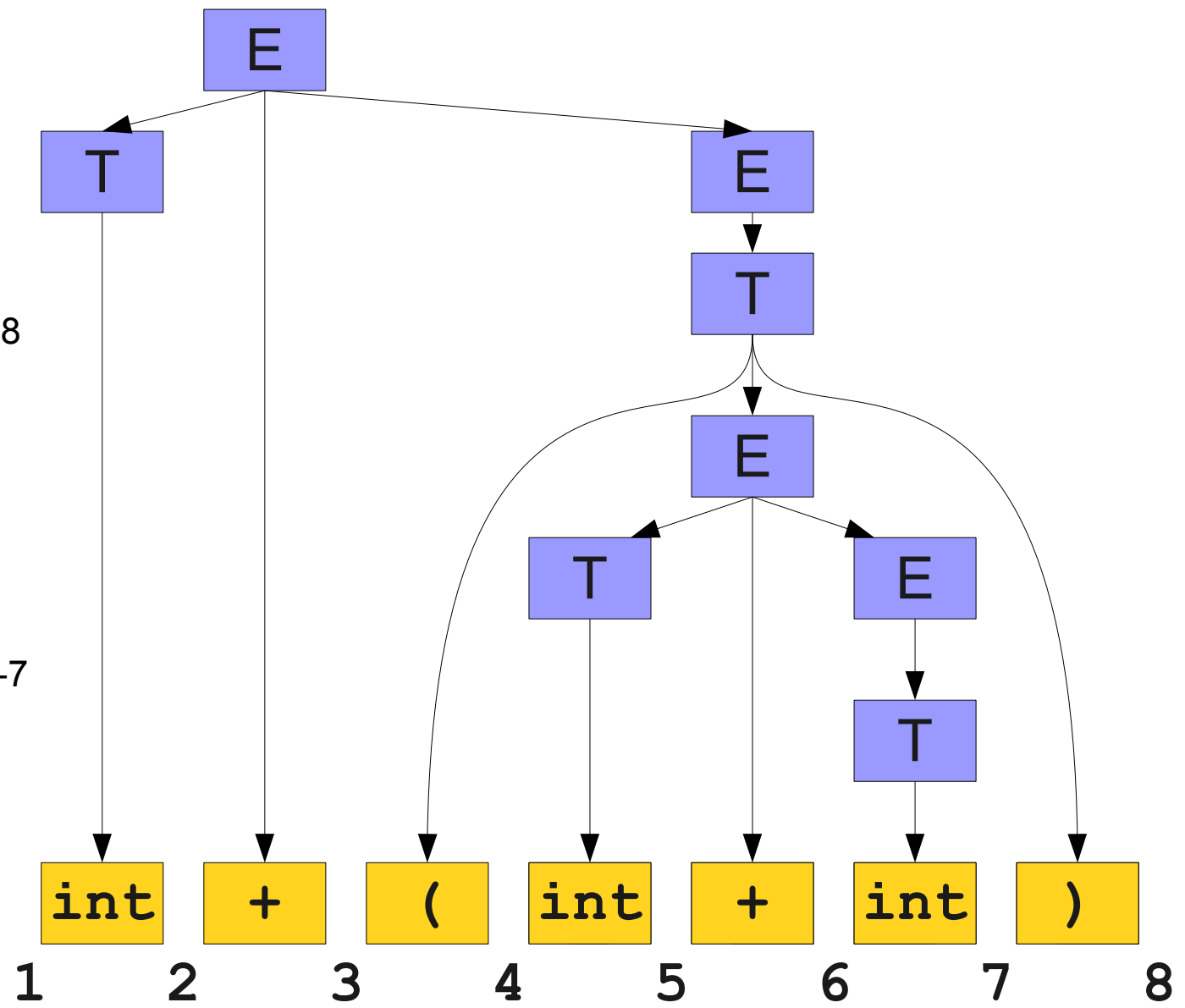

$E \rightarrow E + E$
 $E \rightarrow \text{int}$

Several Parse Trees

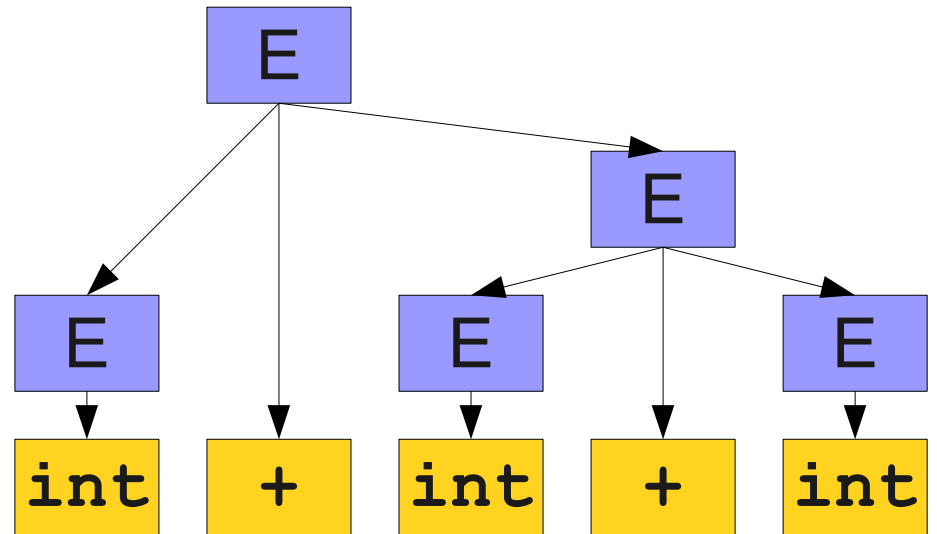
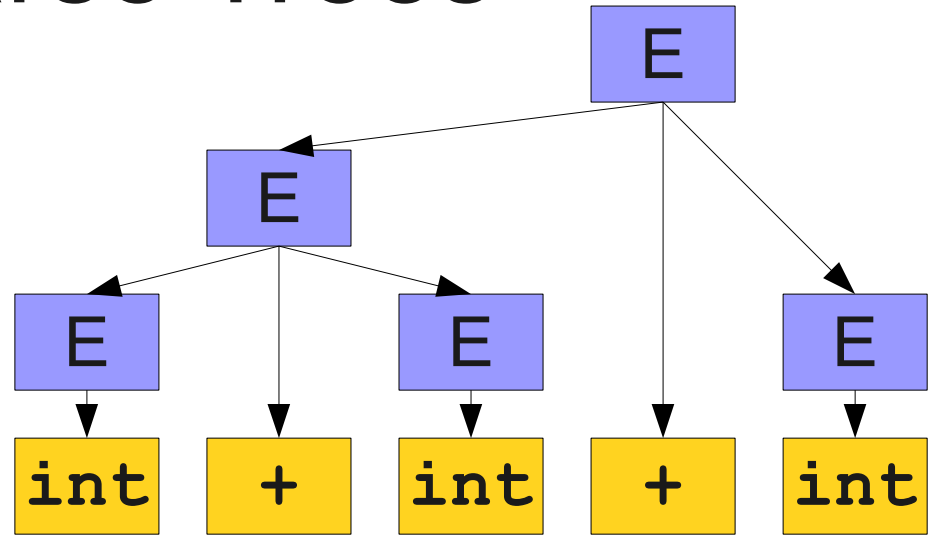

$E \rightarrow E + E$
 $E \rightarrow \text{int}$

Several Parse Trees

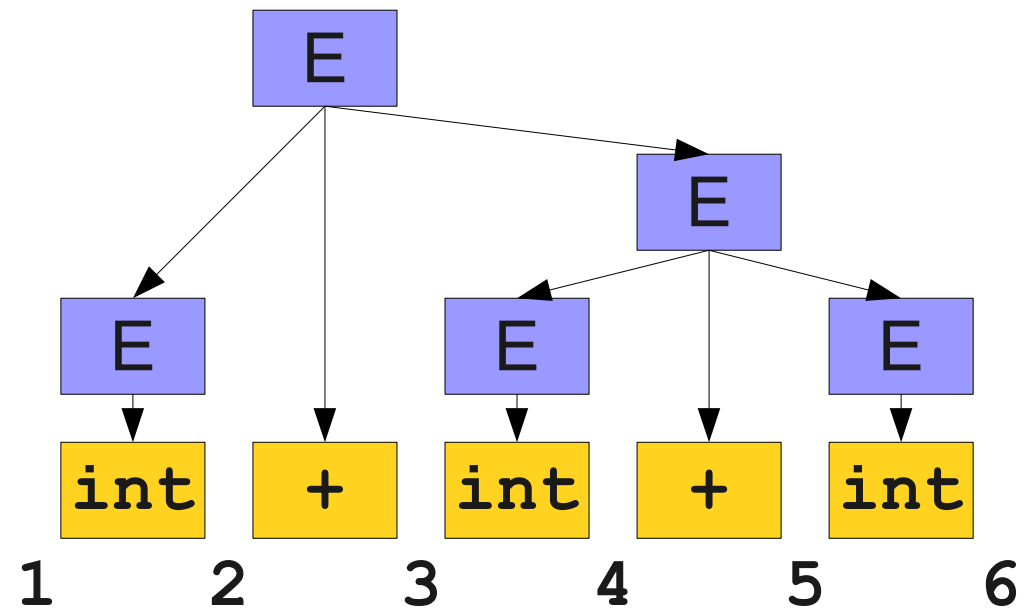
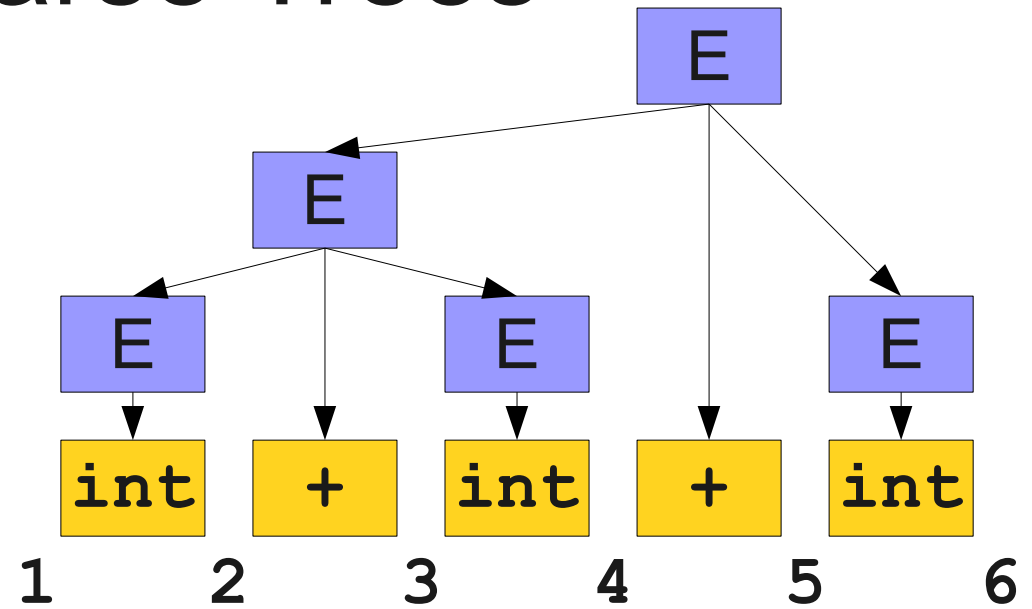

$E \rightarrow E + E$
 $E \rightarrow \text{int}$

Several Parse Trees

$S \rightarrow E_{1-6}$

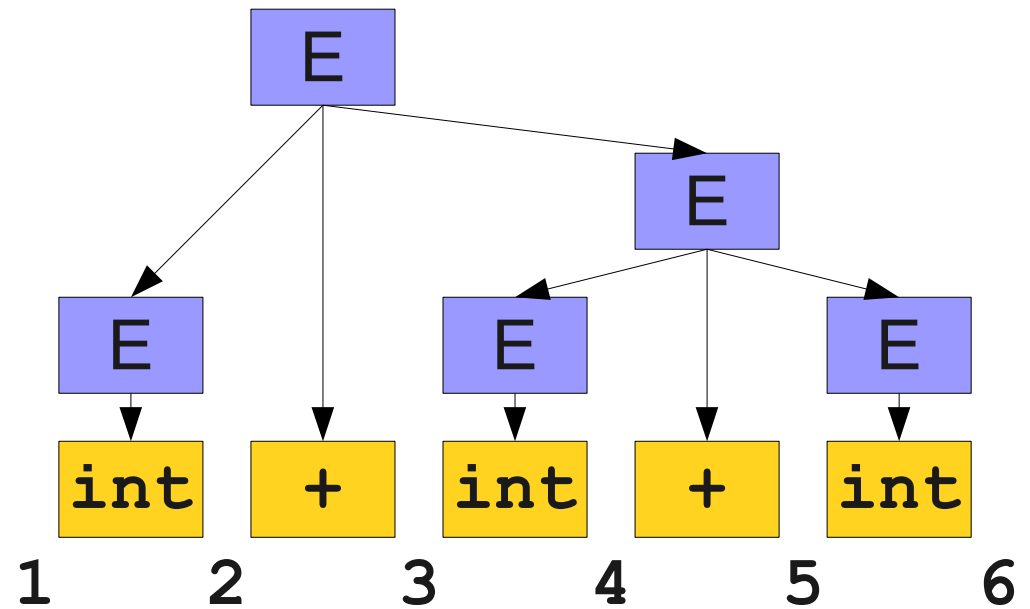
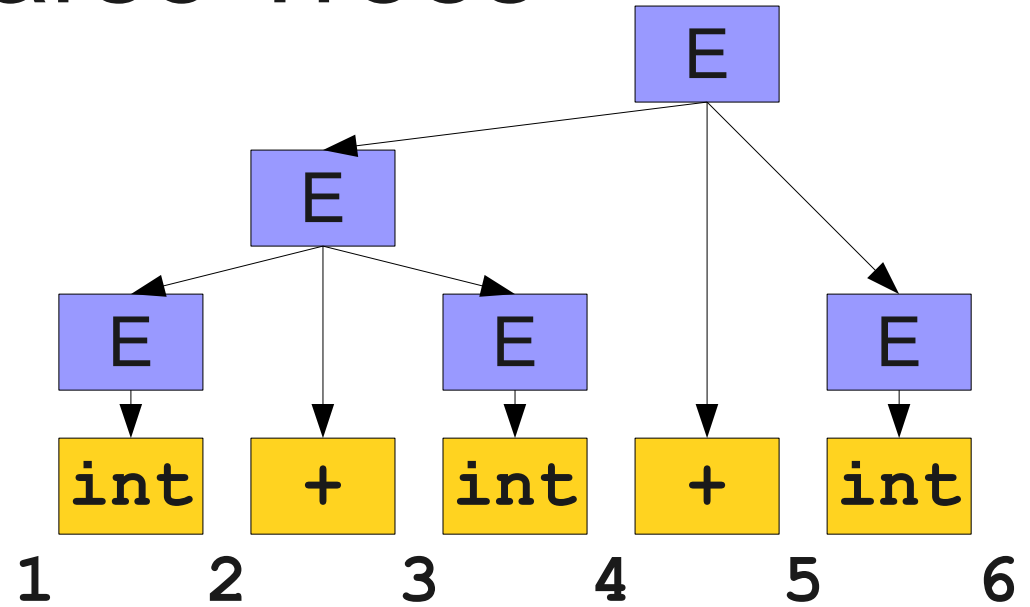

$E \rightarrow E + E$
 $E \rightarrow \text{int}$

Several Parse Trees

$S \rightarrow E_{1-6}$
 $E_{1-6} \rightarrow E_{1-4} +_{4-5} E_{5-6}$
 $E_{1-6} \rightarrow E_{1-2} +_{2-3} E_{3-6}$

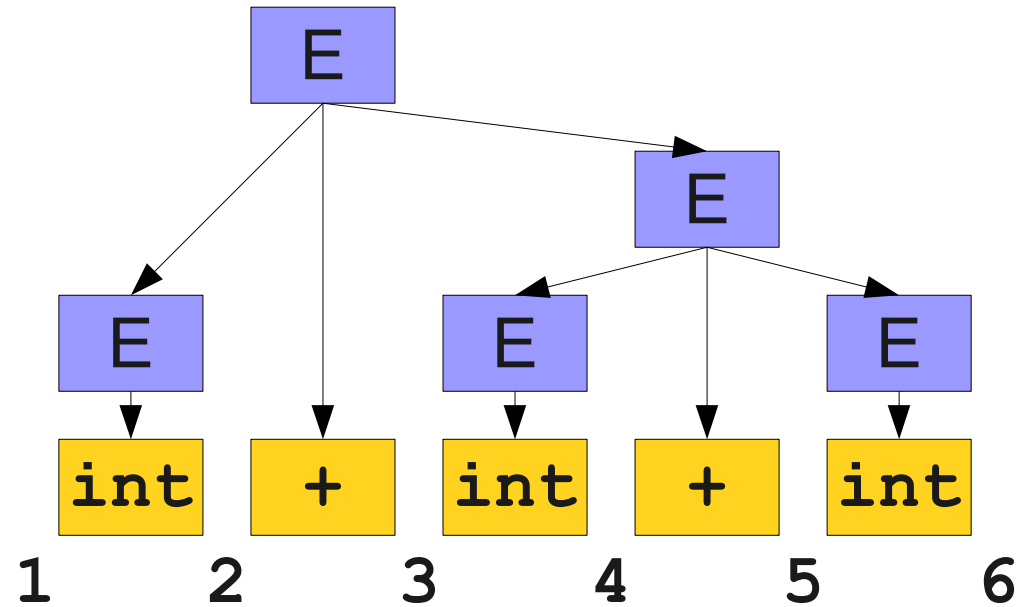
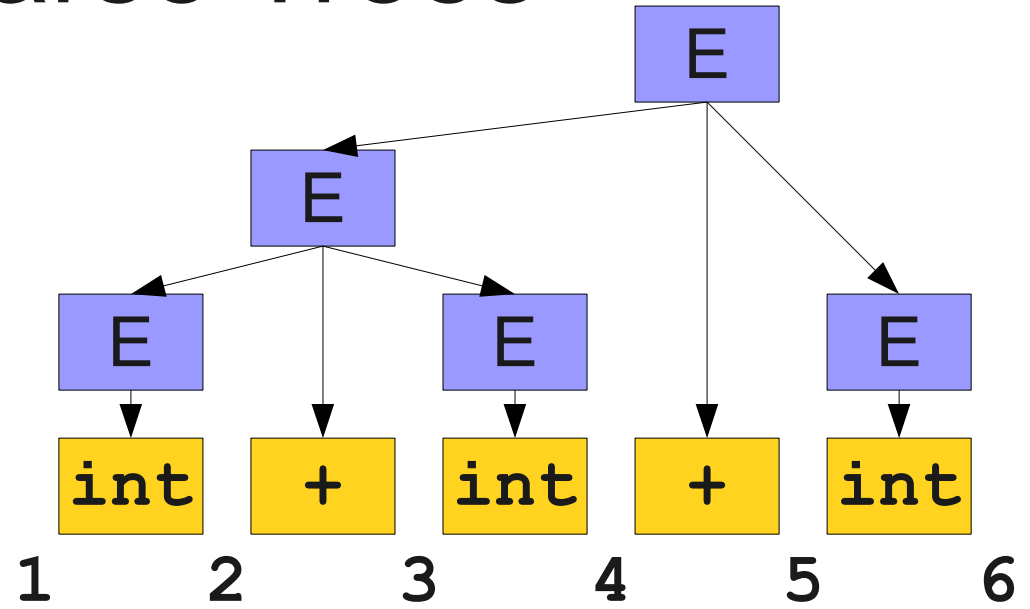

$E \rightarrow E + E$
 $E \rightarrow \text{int}$

Several Parse Trees

$S \rightarrow E_{1-6}$
 $E_{1-6} \rightarrow E_{1-4} +_{4-5} E_{5-6}$
 $E_{1-6} \rightarrow E_{1-2} +_{2-3} E_{3-6}$
 $E_{1-4} \rightarrow E_{1-2} +_{2-3} E_{3-4}$

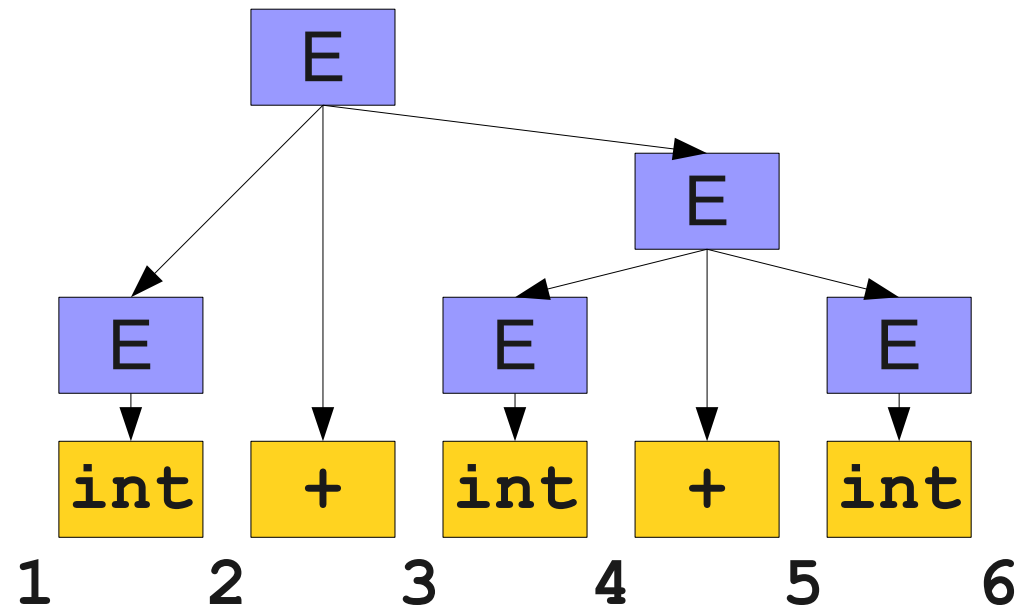
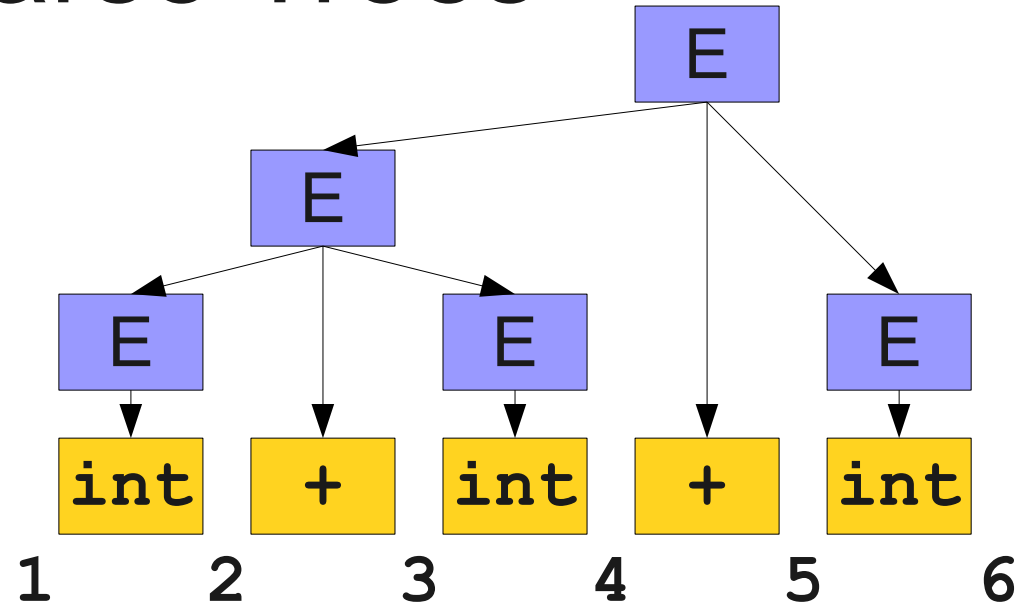

$E \rightarrow E + E$
 $E \rightarrow \text{int}$

Several Parse Trees

$S \rightarrow E$

1-6

$E_{1-6} \rightarrow$

E_{1-4}

$+_{4-5}$

E_{5-6}

$E_{1-6} \rightarrow$

E_{1-2}

$+_{2-3}$

E_{3-6}

$E_{1-4} \rightarrow$

E_{1-2}

$+_{2-3}$

E_{3-4}

$E_{3-6} \rightarrow$

E_{3-4}

$+_{4-5}$

E_{5-6}

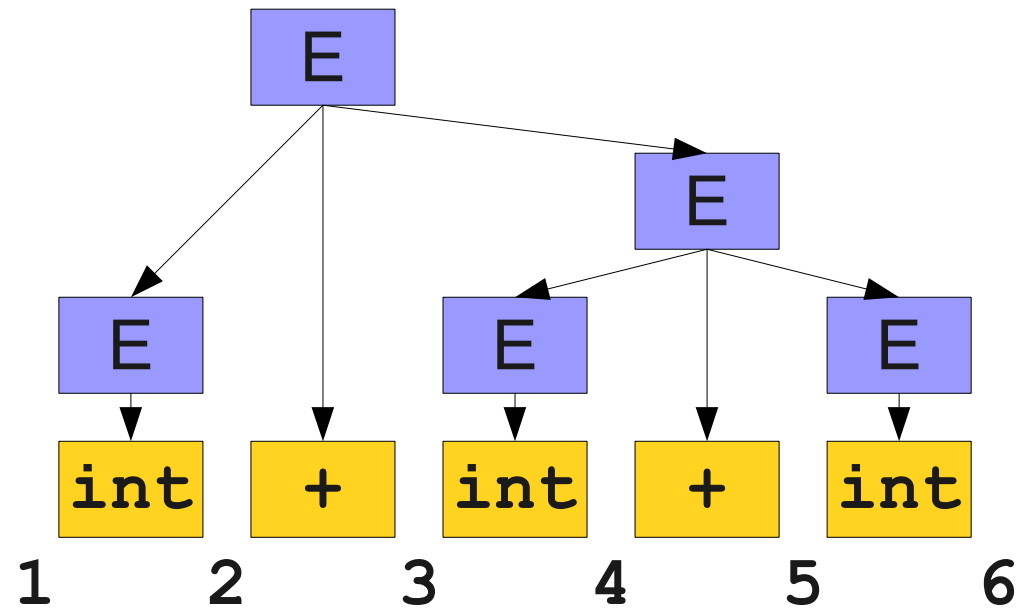
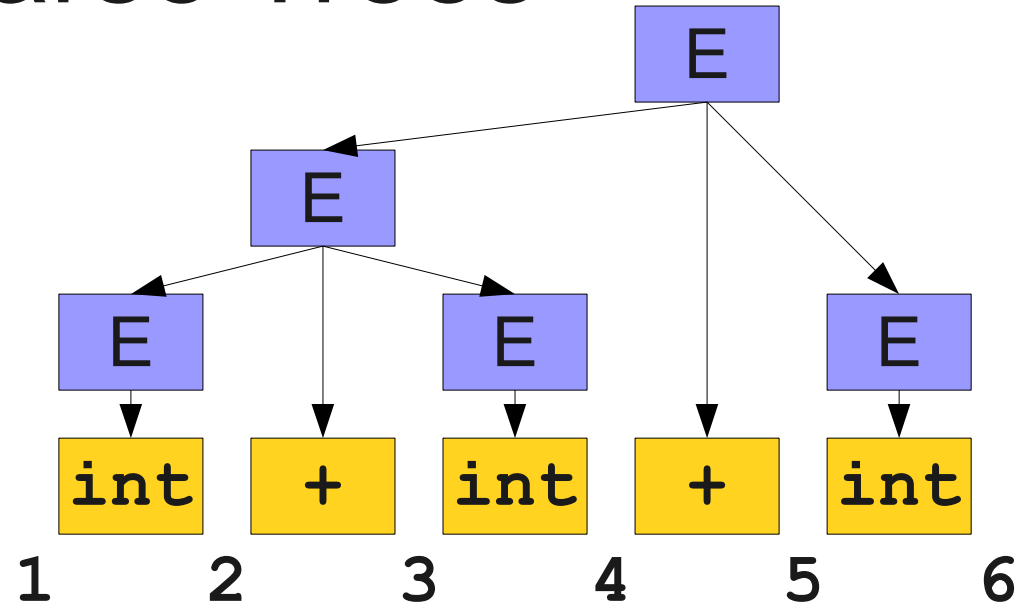

$E \rightarrow E + E$
 $E \rightarrow \text{int}$

Several Parse Trees

$S \rightarrow E$

1-6

$E_{1-6} \rightarrow$

E_{1-4}

$+_{4-5}$

E_{5-6}

$E_{1-6} \rightarrow$

E_{1-2}

$+_{2-3}$

E_{3-6}

$E_{1-4} \rightarrow$

E_{1-2}

$+_{2-3}$

E_{3-4}

$E_{3-6} \rightarrow$

E_{3-4}

$+_{4-5}$

E_{5-6}

$E_{1-2} \rightarrow$

int_{1-2}

$E_{3-4} \rightarrow$

int_{3-4}

$E_{5-6} \rightarrow$

int_{5-6}

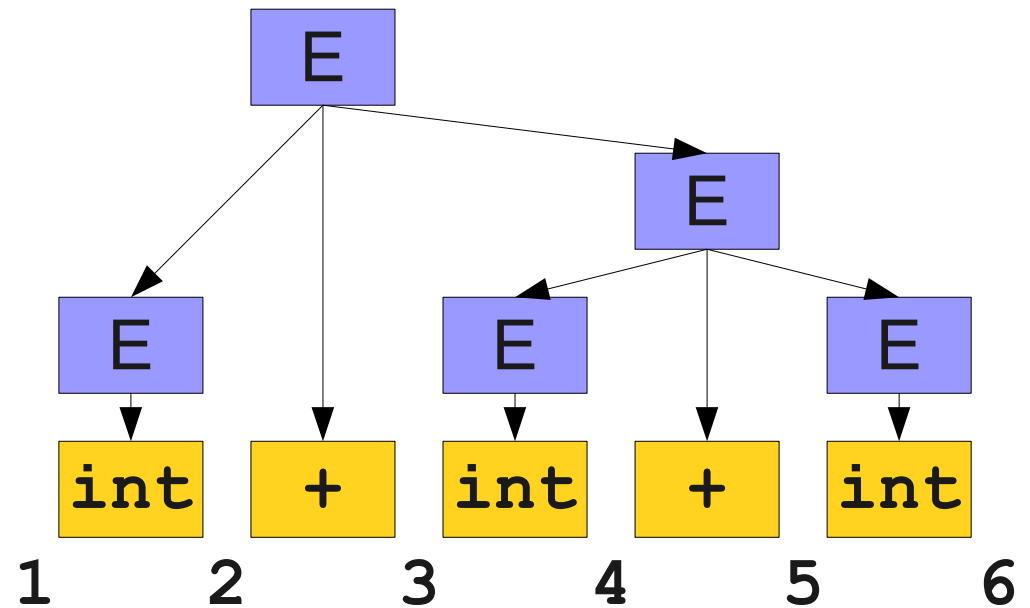
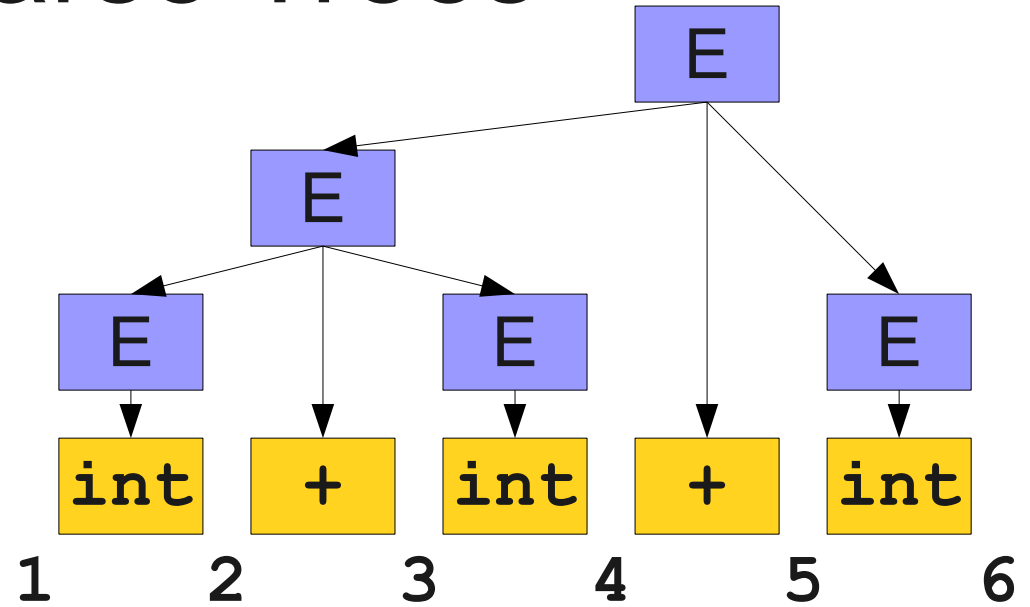

A parse-forest grammar is a context-free grammar for parse trees.

An Infinitely Ambiguous Grammar

$X \rightarrow X$

$X \rightarrow a$

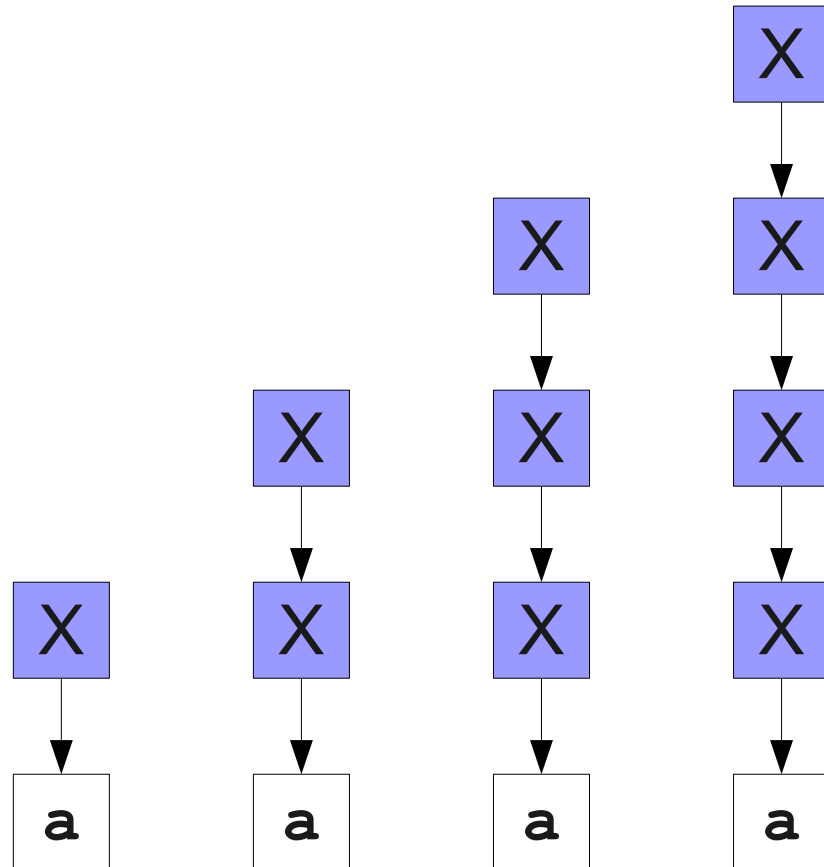

An Infinitely Ambiguous Grammar

$X \rightarrow X$

$X \rightarrow a$

$S \rightarrow X_{1-2}$

$X_{1-2} \rightarrow X_{1-2}$

$X_{1-2} \rightarrow a_{1-2}$

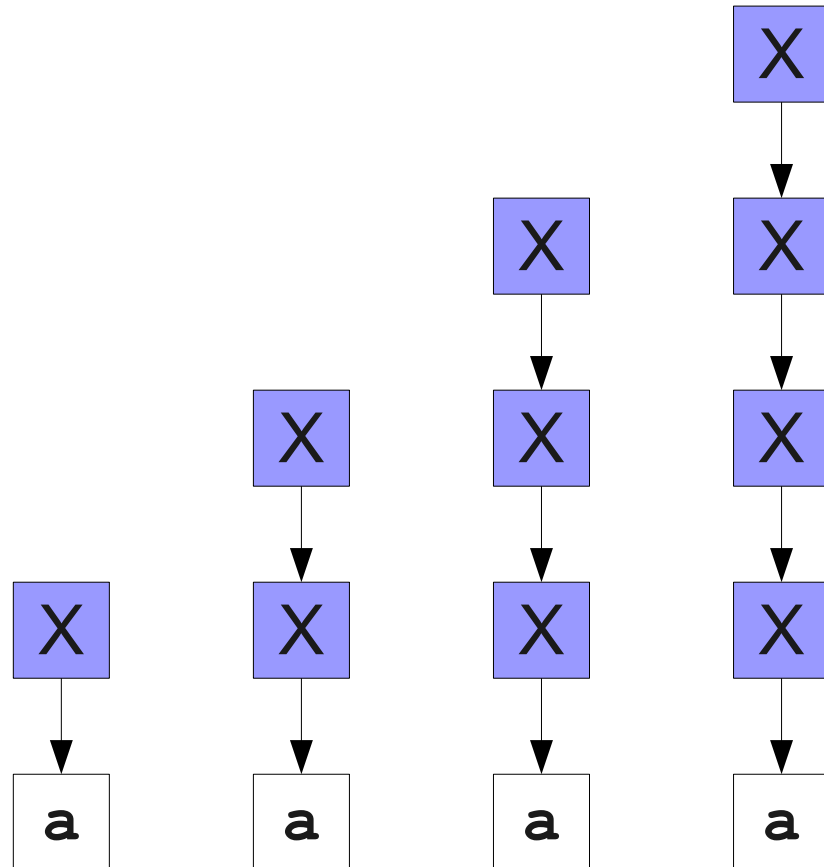

A Highly Ambiguous Grammar

$X \rightarrow XX$

$X \rightarrow a$

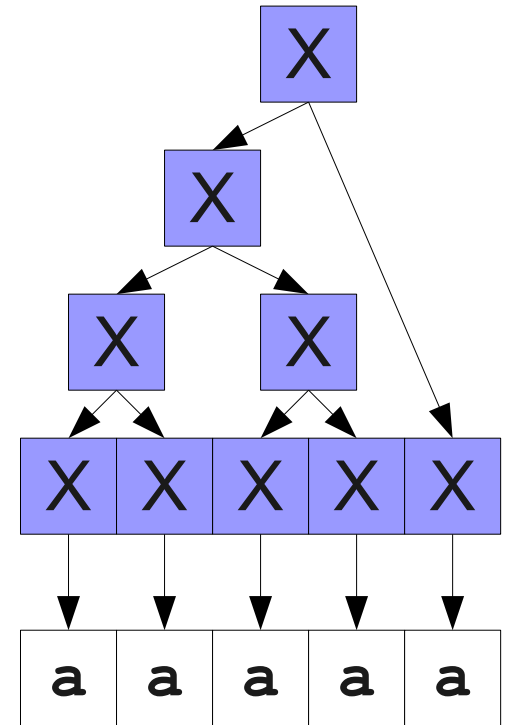

A Highly Ambiguous Grammar

$X \rightarrow XX$
 $X \rightarrow a$

$S \rightarrow X_{1-2} X_{2-6}$

$S \rightarrow X_{1-3} X_{3-6}$

$S \rightarrow X_{1-4} X_{4-6}$

$S \rightarrow X_{1-5} X_{5-6}$

$X_{1-2} \rightarrow a_{1-2}$

$X_{2-3} \rightarrow a_{2-3}$

$X_{3-4} \rightarrow a_{3-4}$

$X_{4-5} \rightarrow a_{4-5}$

$X_{5-6} \rightarrow a_{5-6}$

$X_{1-3} \rightarrow X_{1-2} X_{2-3}$

$X_{2-4} \rightarrow X_{2-3} X_{3-4}$

$X_{3-5} \rightarrow X_{3-4} X_{4-5}$

$X_{4-6} \rightarrow X_{4-5} X_{5-6}$

$X_{1-4} \rightarrow X_{1-2} X_{2-4}$

$X_{1-4} \rightarrow X_{1-3} X_{3-4}$

$X_{2-5} \rightarrow X_{2-3} X_{3-5}$

$X_{2-5} \rightarrow X_{2-4} X_{4-5}$

$X_{3-6} \rightarrow X_{3-4} X_{4-6}$

$X_{3-6} \rightarrow X_{3-5} X_{5-6}$

$X_{1-5} \rightarrow X_{1-2} X_{2-5}$

$X_{1-5} \rightarrow X_{1-3} X_{3-5}$

$X_{1-5} \rightarrow X_{1-4} X_{4-5}$

$X_{2-6} \rightarrow X_{2-3} X_{3-6}$

$X_{2-6} \rightarrow X_{2-4} X_{4-6}$

$X_{2-6} \rightarrow X_{2-5} X_{5-6}$

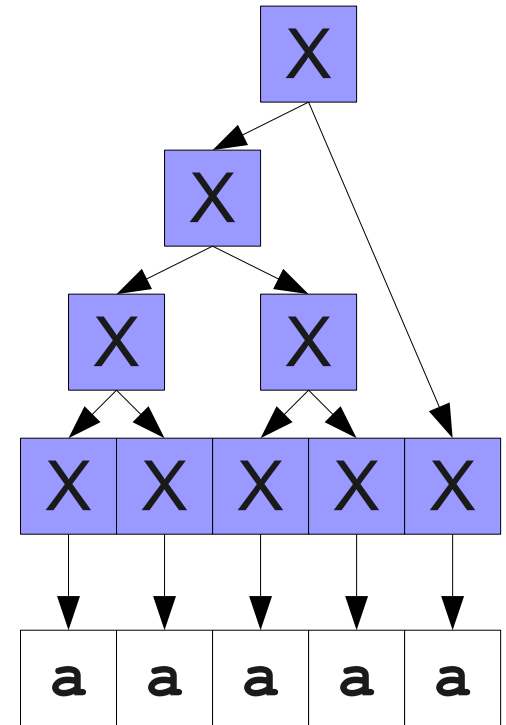

Parse Forest Grammars

- Compact framework for encoding (potentially infinitely many!) parse trees.
- Output of most (but not all) ambiguous grammar parsers.
- Size not guaranteed to be a polynomial in the size of the grammar.
 - May have every possible partition of every production in the parse tree; size is $O(n^{k+1})$, where k is the length of the longest production.
- This is not a problem in practice.
 - Real grammars rarely trigger this behavior.
 - Techniques exist to obtain worst-case $O(n^3)$ size.

Building an Earley Parser

- **Idea:** Build up a parse-forest grammar as we compute item sets.
- Whenever we **complete** an item, add it to the resulting grammar.
- This will introduce unnecessary rules; we'll fix this later on.
- Some details are tricky; see Grune and Jacobs Ch. 13 for some of the finer points.

$S \rightarrow A$
 $A \rightarrow Ba$
 $A \rightarrow Bb$
 $A \rightarrow Cab$
 $A \rightarrow Ad$
 $B \rightarrow a$
 $C \rightarrow a$

Earley Parsing

$S \rightarrow A$
 $A \rightarrow Ba$
 $A \rightarrow Bb$
 $A \rightarrow Cab$
 $A \rightarrow Ad$
 $B \rightarrow a$
 $C \rightarrow a$

Earley Parsing

a	a	d
---	---	---

$S \rightarrow A$
 $A \rightarrow Ba$
 $A \rightarrow Bb$
 $A \rightarrow Cab$
 $A \rightarrow Ad$
 $B \rightarrow a$
 $C \rightarrow a$

Earley Parsing

a

a

d

$S \rightarrow A$
 $A \rightarrow Ba$
 $A \rightarrow Bb$
 $A \rightarrow Cab$
 $A \rightarrow Ad$
 $B \rightarrow a$
 $C \rightarrow a$

Earley Parsing

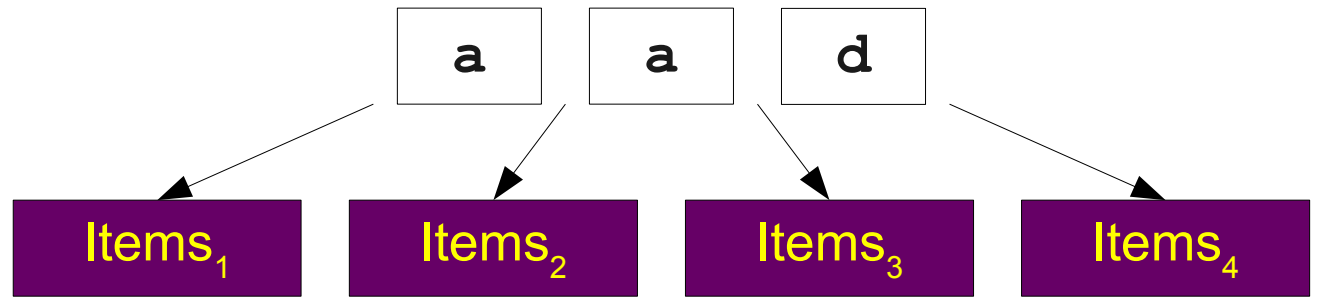

$S \rightarrow A$
 $A \rightarrow Ba$
 $A \rightarrow Bb$
 $A \rightarrow Cab$
 $A \rightarrow Ad$
 $B \rightarrow a$
 $C \rightarrow a$

Earley Parsing

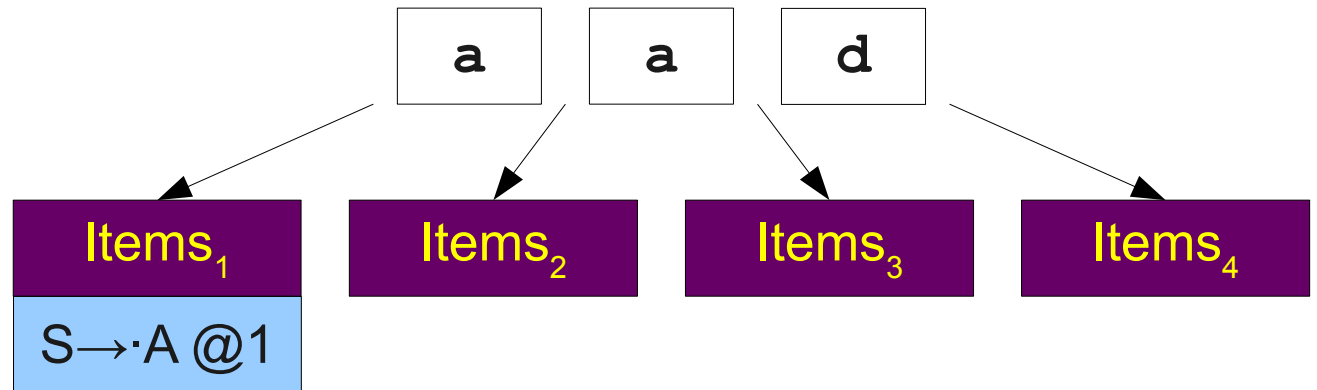

$S \rightarrow A$
 $A \rightarrow Ba$
 $A \rightarrow Bb$
 $A \rightarrow Cab$
 $A \rightarrow Ad$
 $B \rightarrow a$
 $C \rightarrow a$

Earley Parsing

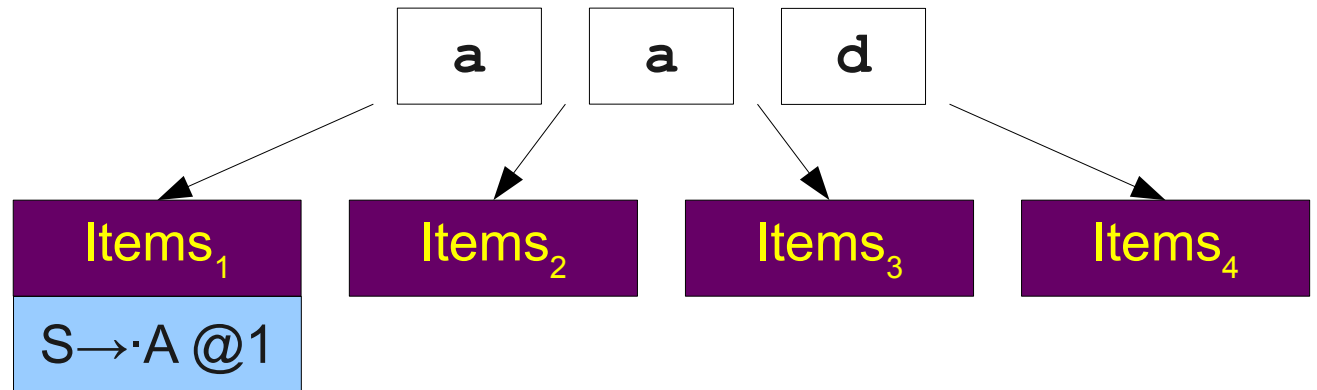
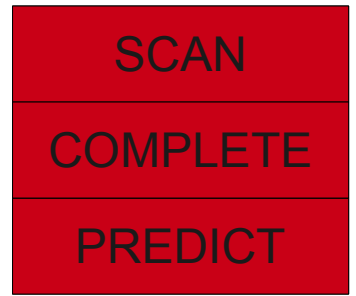

$S \rightarrow A$
 $A \rightarrow Ba$
 $A \rightarrow Bb$
 $A \rightarrow Cab$
 $A \rightarrow Ad$
 $B \rightarrow a$
 $C \rightarrow a$

Earley Parsing

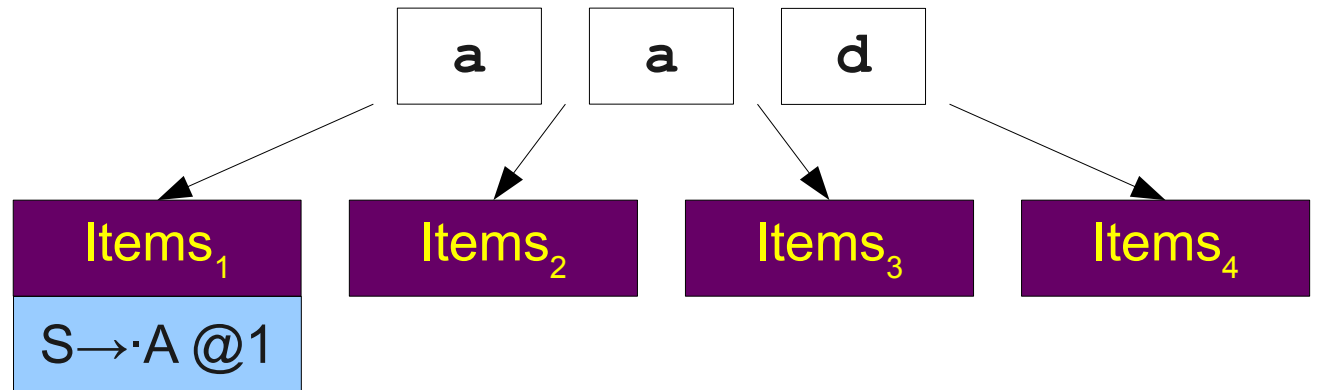
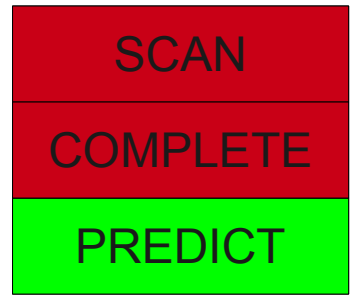

$S \rightarrow A$
 $A \rightarrow Ba$
 $A \rightarrow Bb$
 $A \rightarrow Cab$
 $A \rightarrow Ad$
 $B \rightarrow a$
 $C \rightarrow a$

Earley Parsing

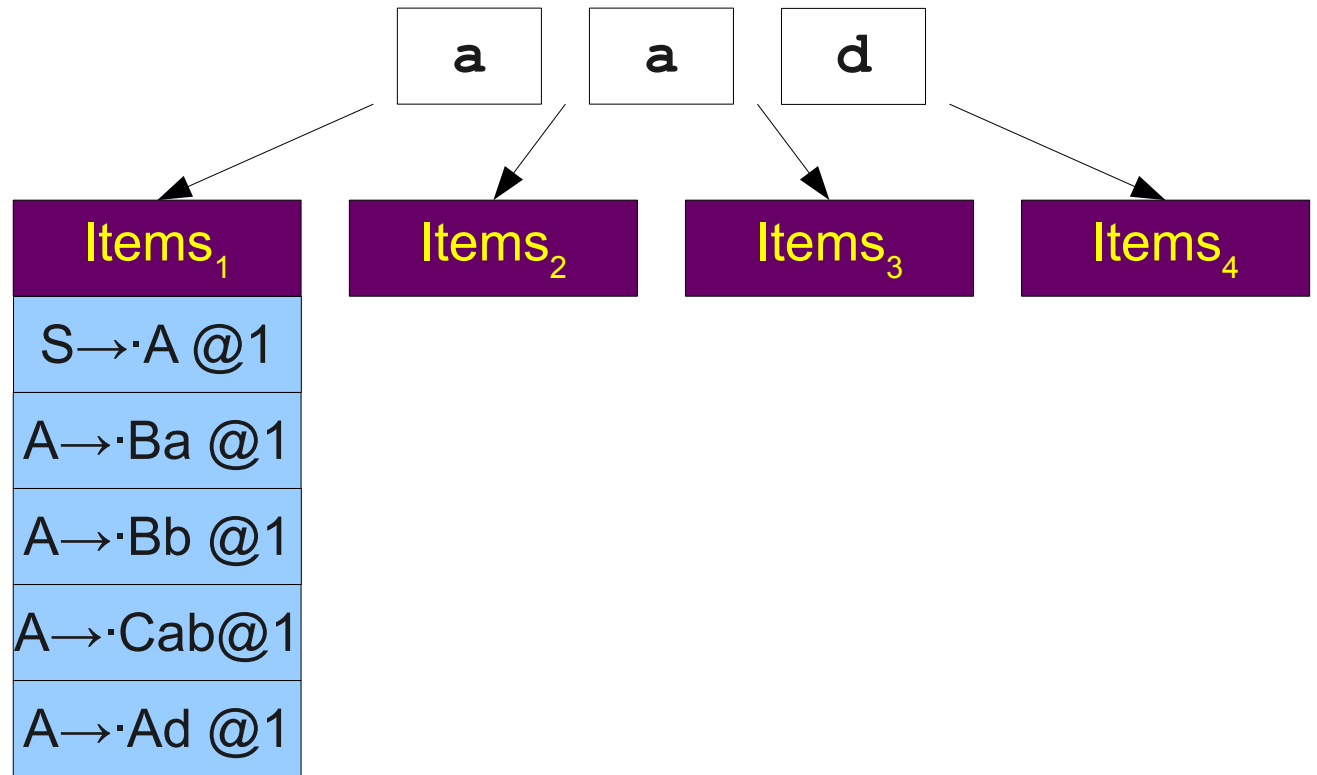
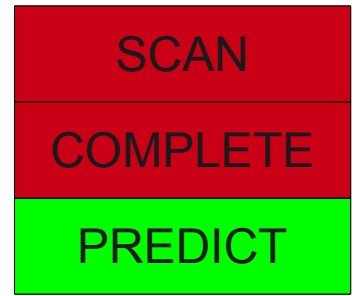

$S \rightarrow A$
 $A \rightarrow Ba$
 $A \rightarrow Bb$
 $A \rightarrow Cab$
 $A \rightarrow Ad$
 $B \rightarrow a$
 $C \rightarrow a$

Earley Parsing

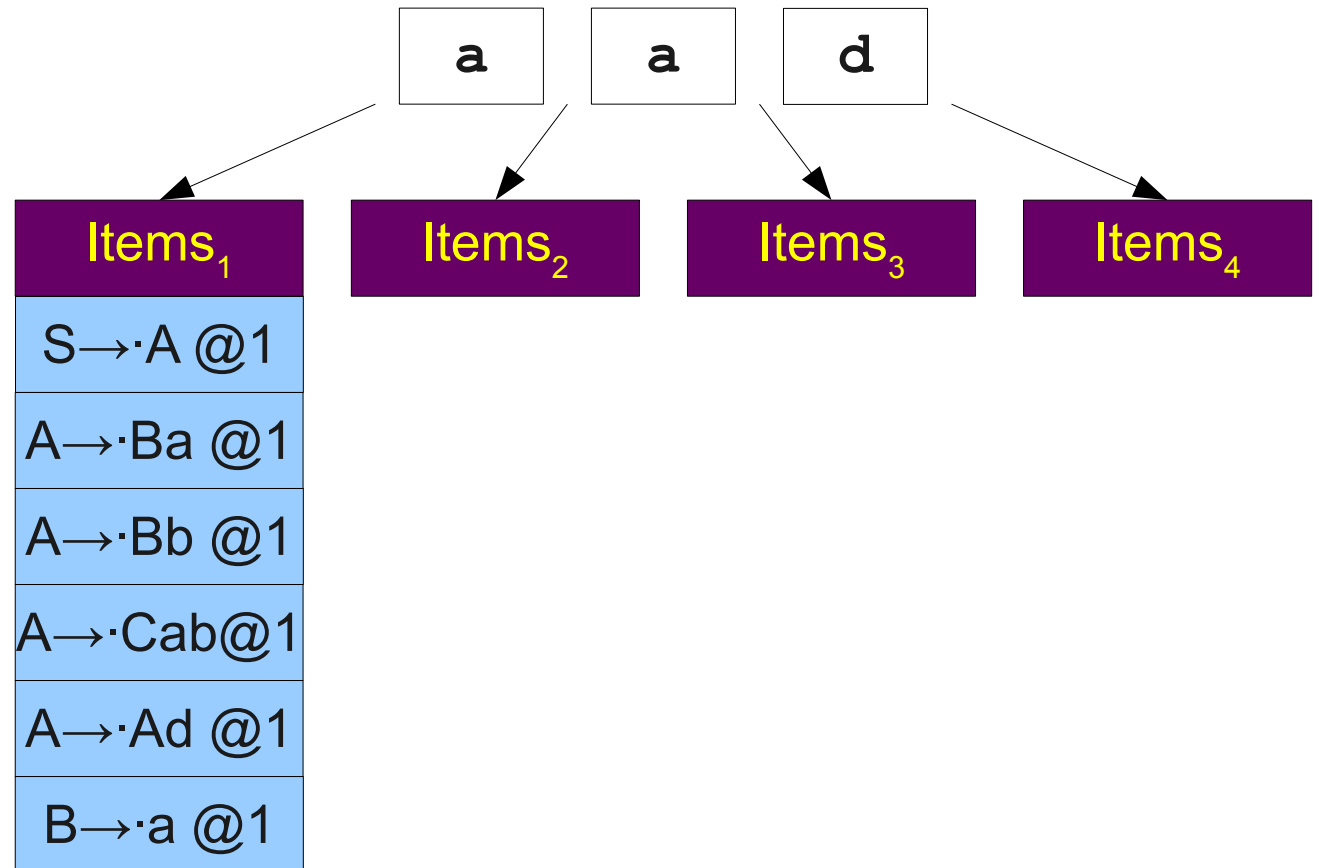
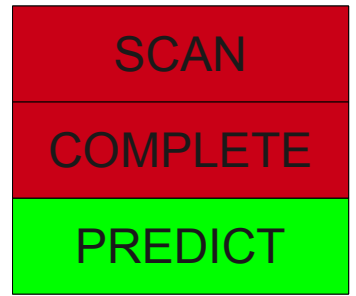

$S \rightarrow A$
 $A \rightarrow Ba$
 $A \rightarrow Bb$
 $A \rightarrow Cab$
 $A \rightarrow Ad$
 $B \rightarrow a$
 $C \rightarrow a$

Earley Parsing

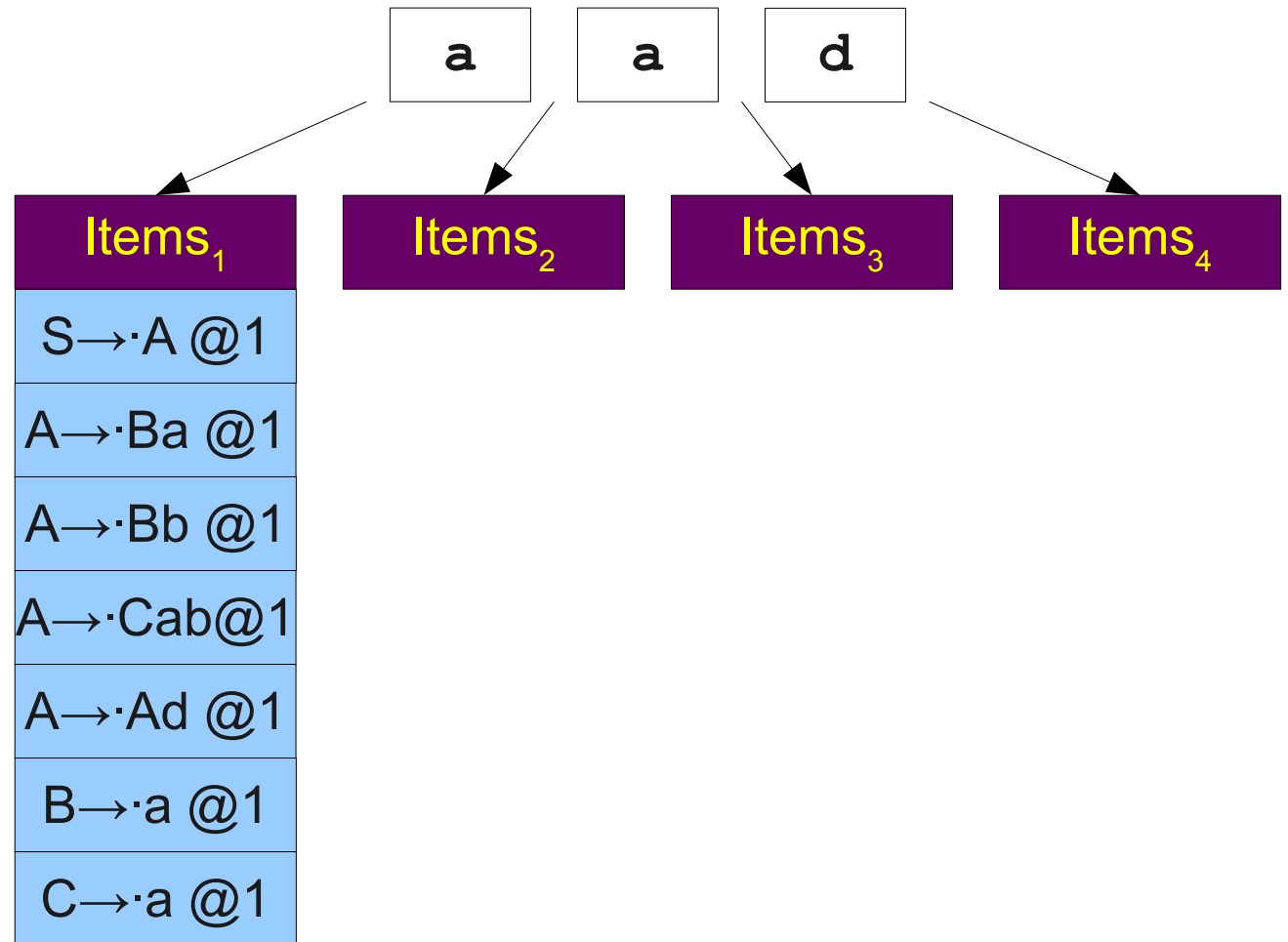
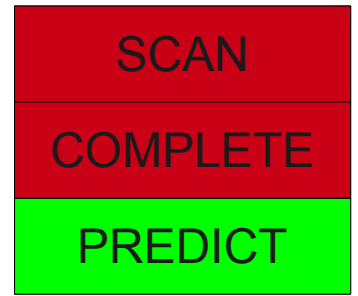

$S \rightarrow A$
 $A \rightarrow Ba$
 $A \rightarrow Bb$
 $A \rightarrow Cab$
 $A \rightarrow Ad$
 $B \rightarrow a$
 $C \rightarrow a$

Earley Parsing

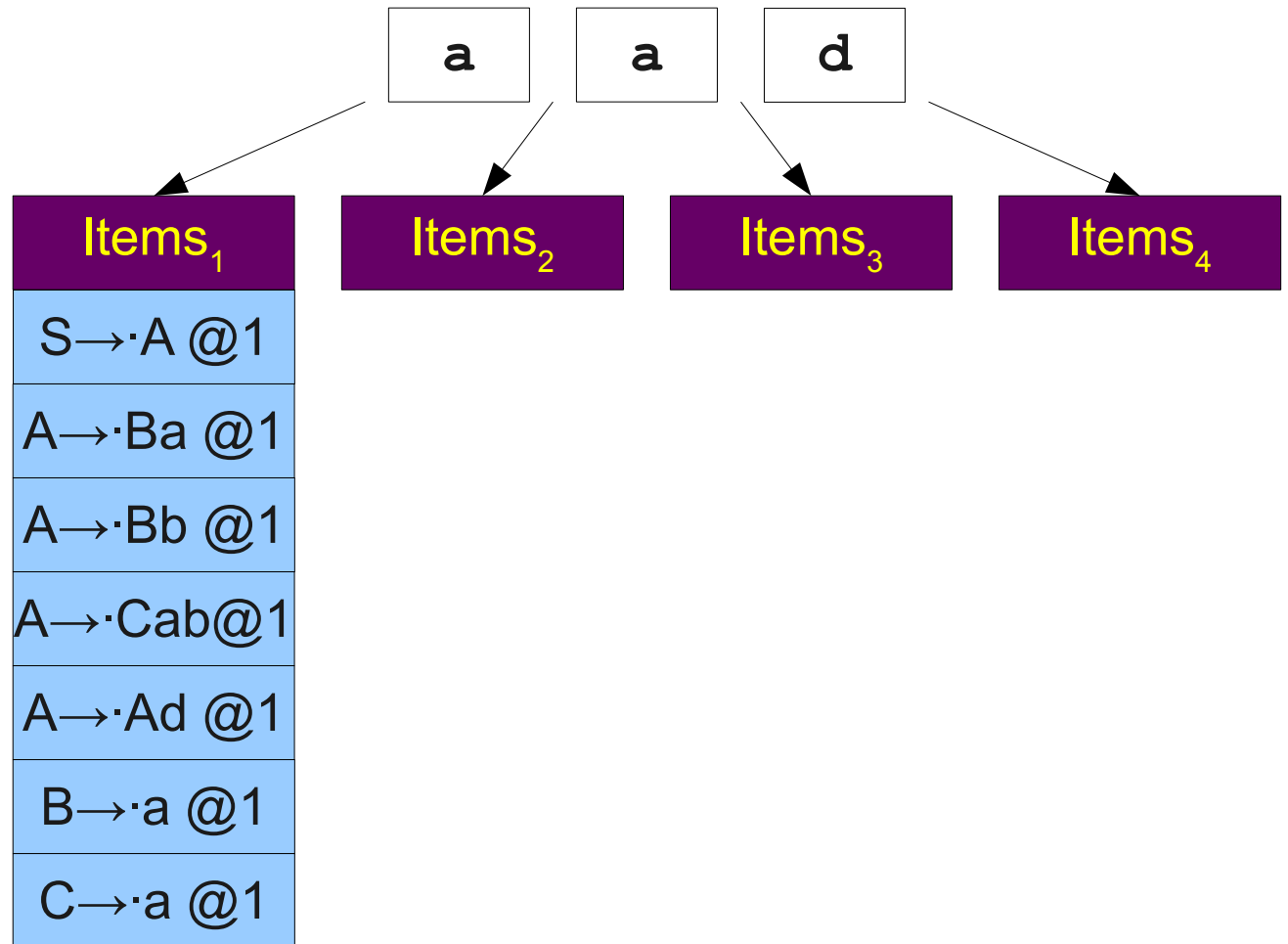

$S \rightarrow A$
 $A \rightarrow Ba$
 $A \rightarrow Bb$
 $A \rightarrow Cab$
 $A \rightarrow Ad$
 $B \rightarrow a$
 $C \rightarrow a$

Earley Parsing

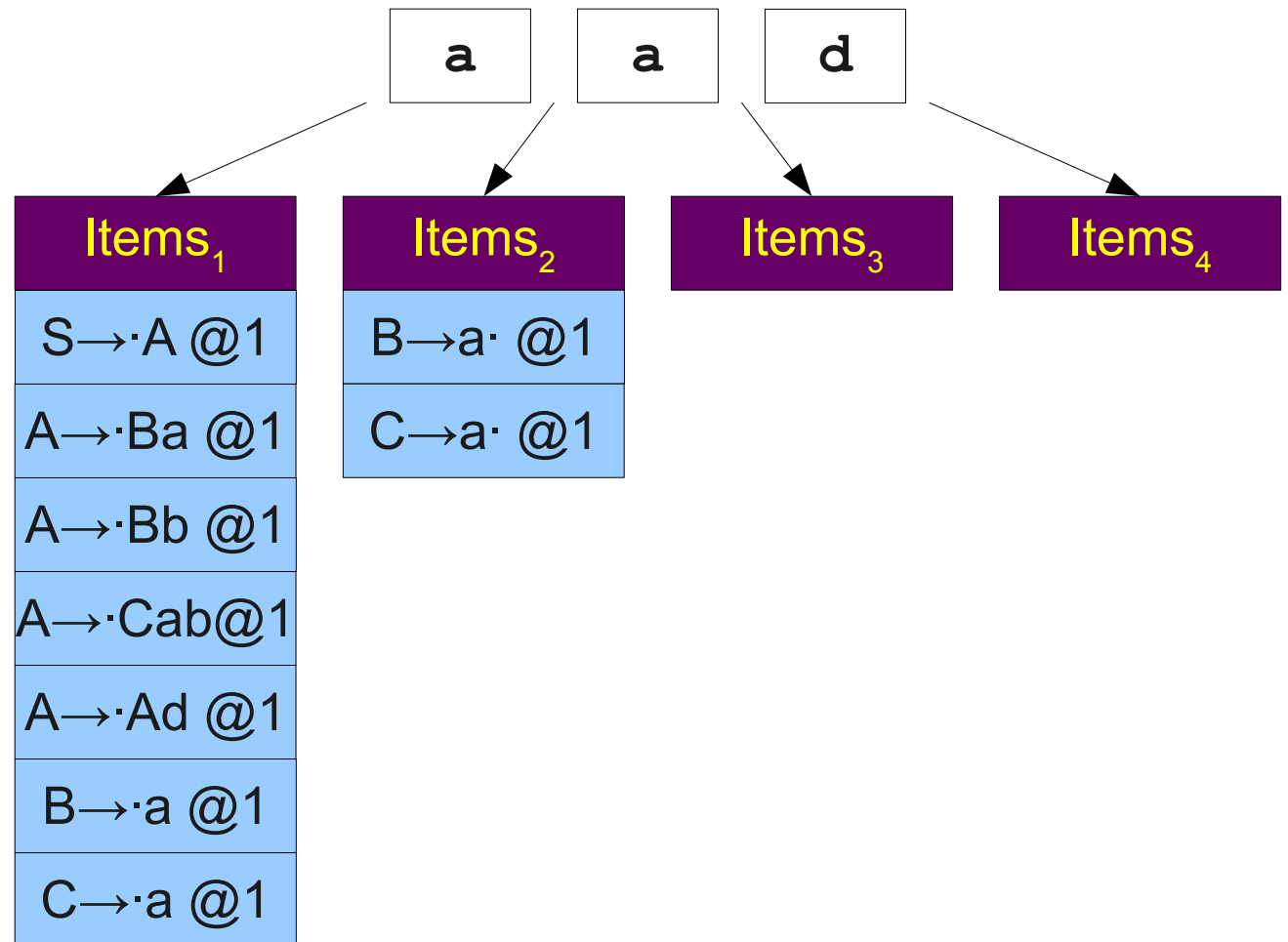

$S \rightarrow A$
 $A \rightarrow Ba$
 $A \rightarrow Bb$
 $A \rightarrow Cab$
 $A \rightarrow Ad$
 $B \rightarrow a$
 $C \rightarrow a$

Earley Parsing

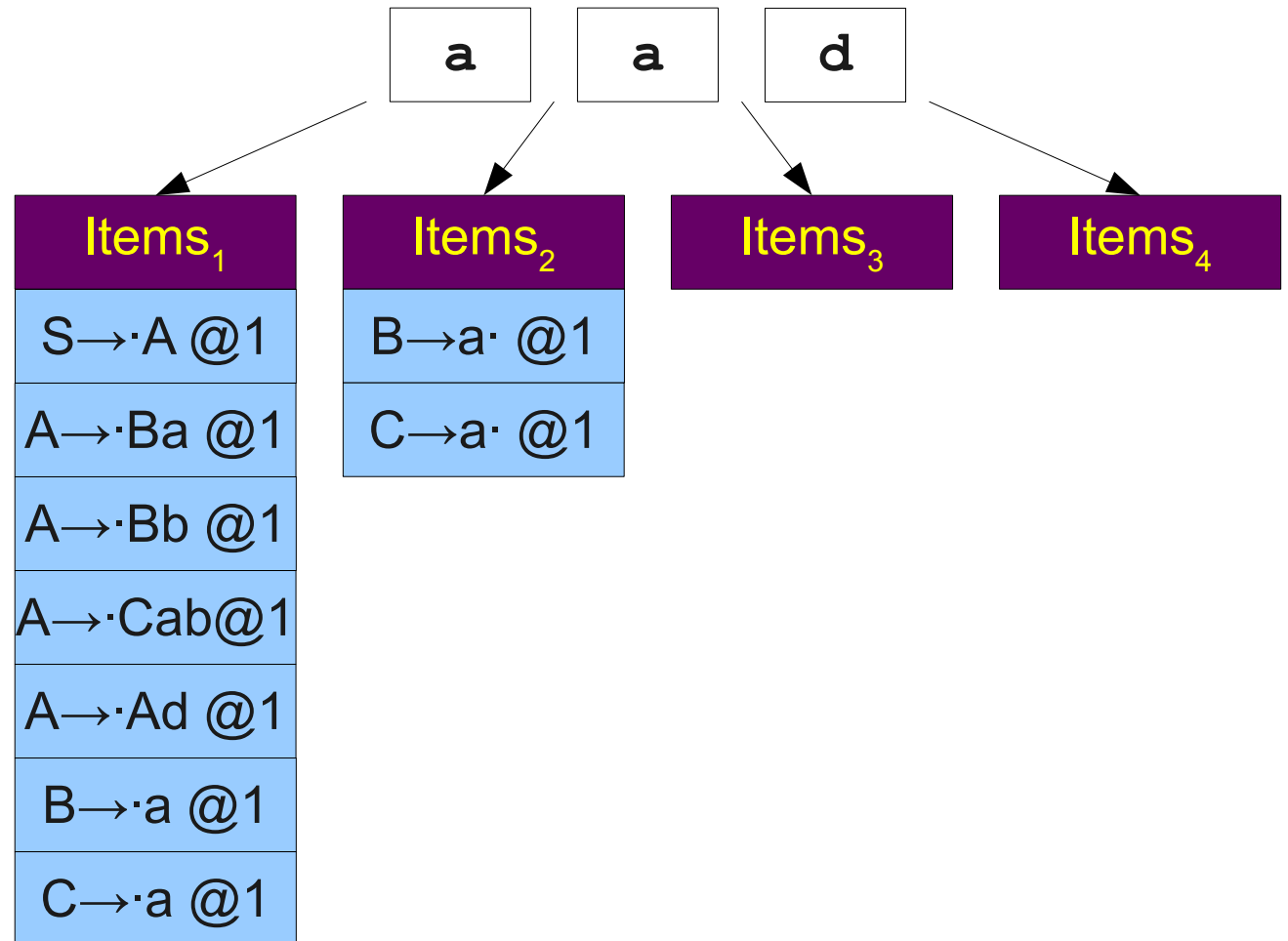
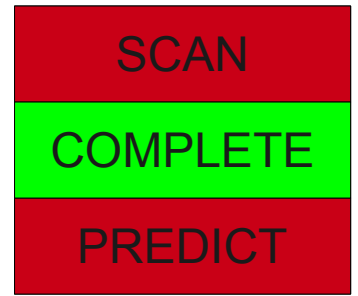

$S \rightarrow A$
 $A \rightarrow Ba$
 $A \rightarrow Bb$
 $A \rightarrow Cab$
 $A \rightarrow Ad$
 $B \rightarrow a$
 $C \rightarrow a$

Earley Parsing

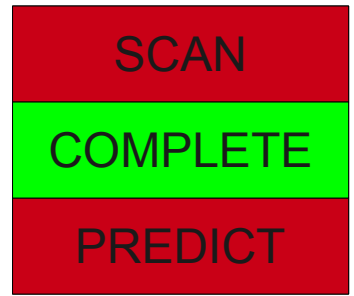

$B_{1-2} \rightarrow a_{1-2}$
 $C_{1-2} \rightarrow a_{1-2}$

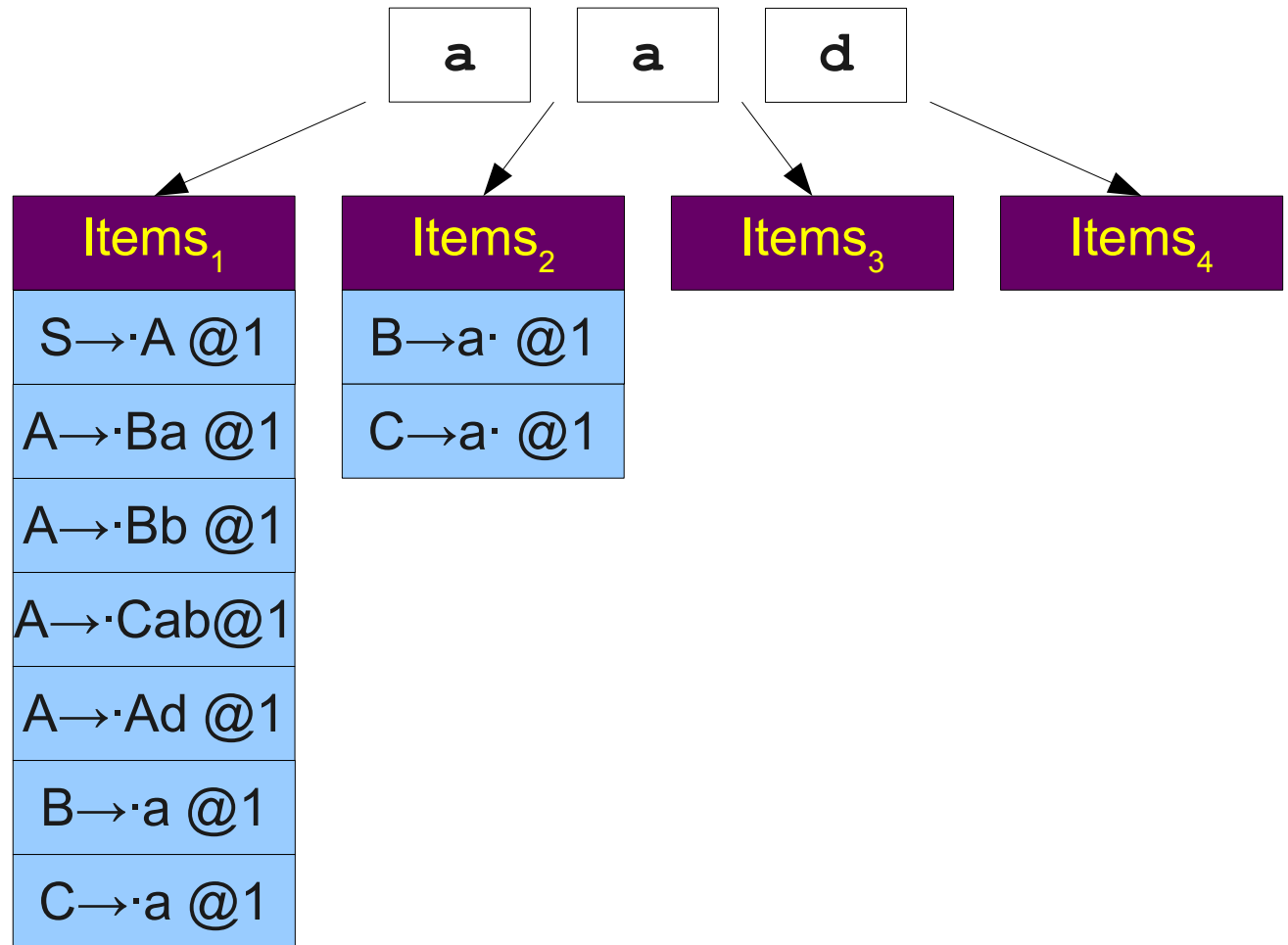

$S \rightarrow A$
 $A \rightarrow Ba$
 $A \rightarrow Bb$
 $A \rightarrow Cab$
 $A \rightarrow Ad$
 $B \rightarrow a$
 $C \rightarrow a$

Earley Parsing

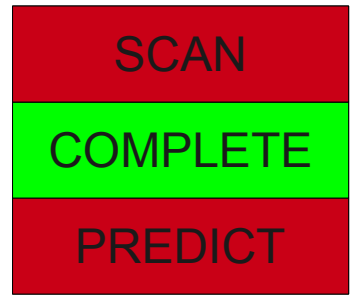

$B_{1-2} \rightarrow a_{1-2}$
 $C_{1-2} \rightarrow a_{1-2}$

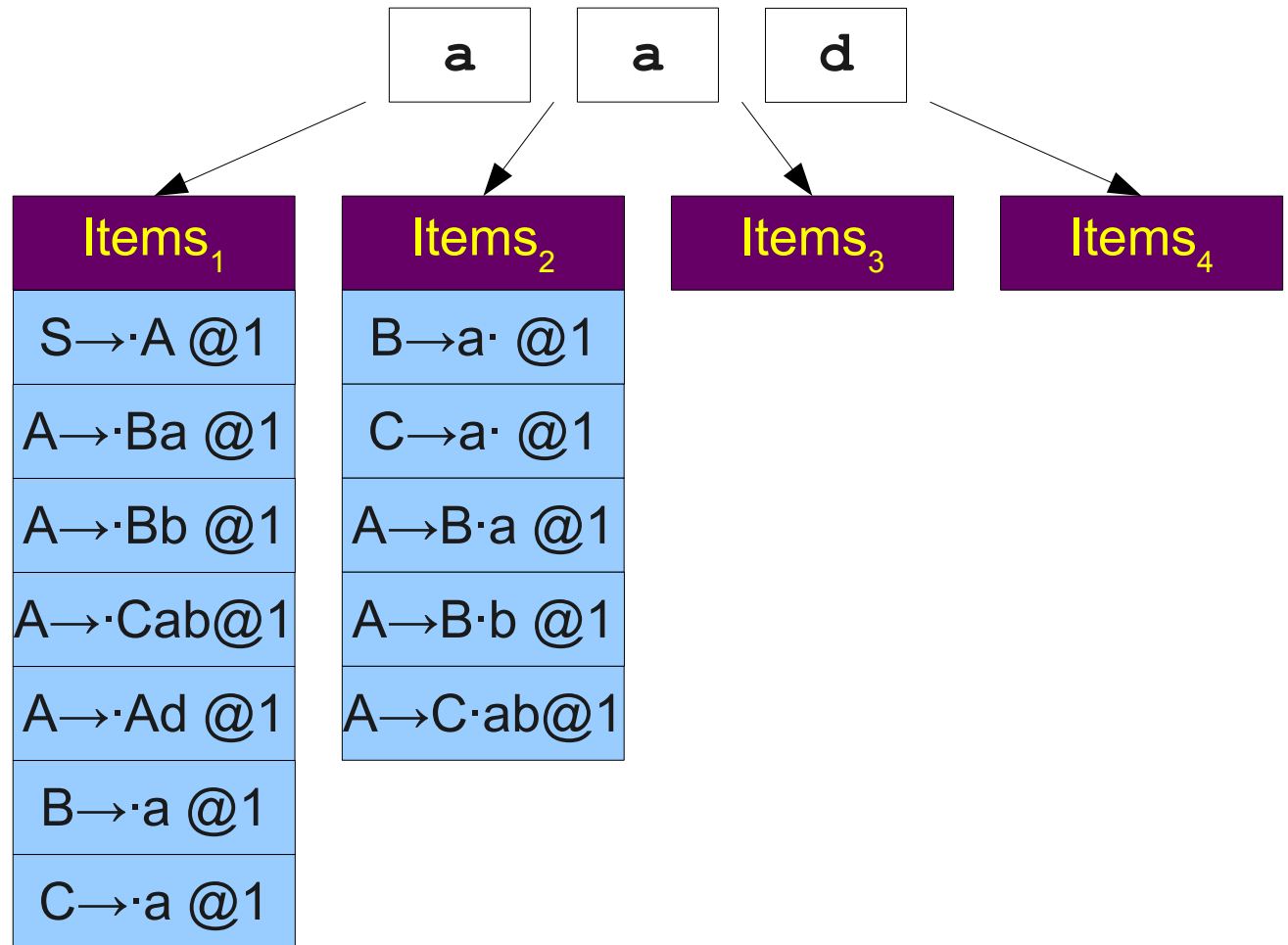

$S \rightarrow A$
 $A \rightarrow Ba$
 $A \rightarrow Bb$
 $A \rightarrow Cab$
 $A \rightarrow Ad$
 $B \rightarrow a$
 $C \rightarrow a$

Earley Parsing



$B_{1-2} \rightarrow a_{1-2}$
 $C_{1-2} \rightarrow a_{1-2}$

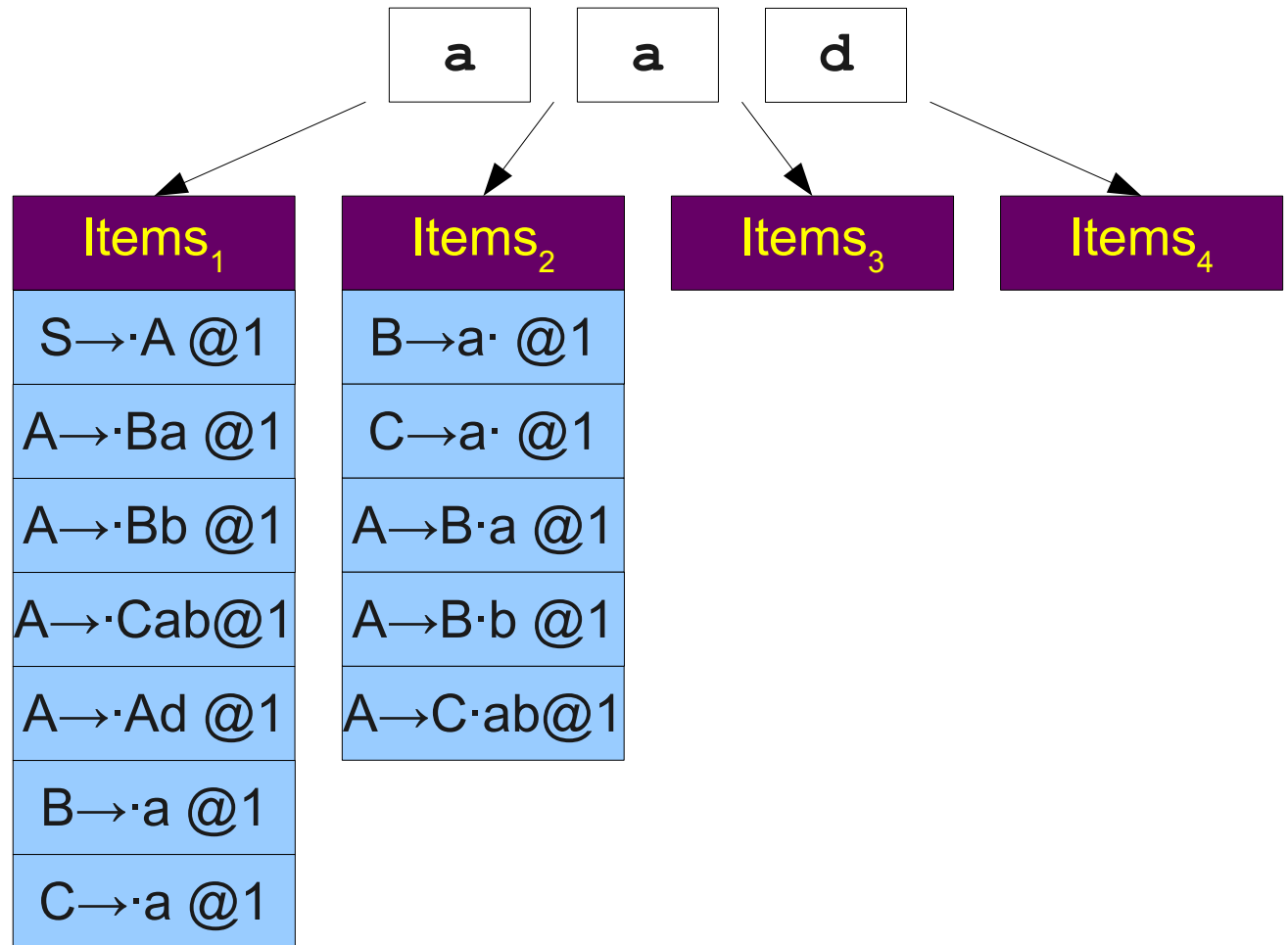

$S \rightarrow A$
 $A \rightarrow Ba$
 $A \rightarrow Bb$
 $A \rightarrow Cab$
 $A \rightarrow Ad$
 $B \rightarrow a$
 $C \rightarrow a$

Earley Parsing



$B_{1-2} \rightarrow a_{1-2}$
 $C_{1-2} \rightarrow a_{1-2}$

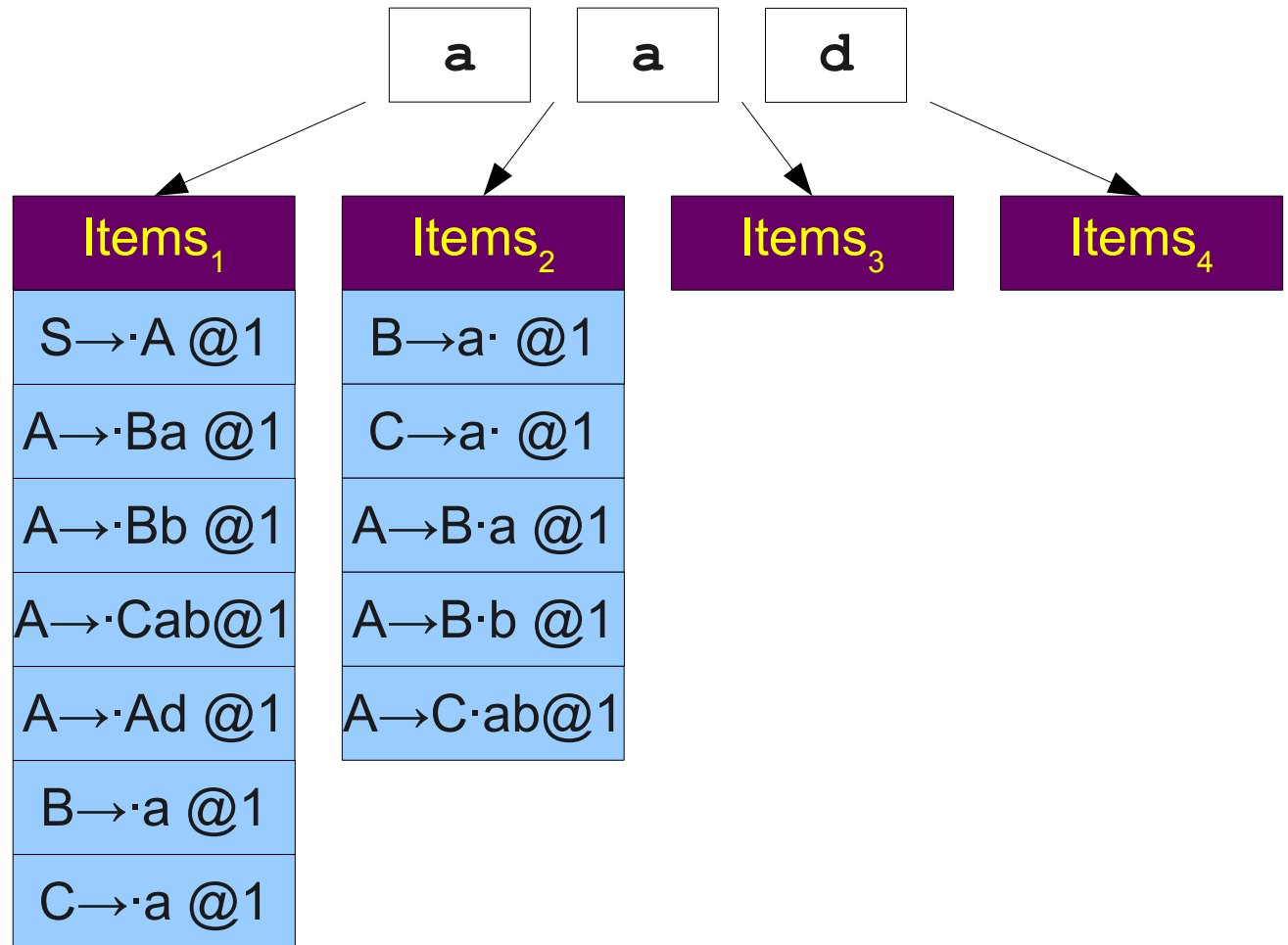

$S \rightarrow A$
 $A \rightarrow Ba$
 $A \rightarrow Bb$
 $A \rightarrow Cab$
 $A \rightarrow Ad$
 $B \rightarrow a$
 $C \rightarrow a$

Earley Parsing



$B_{1-2} \rightarrow a_{1-2}$
 $C_{1-2} \rightarrow a_{1-2}$

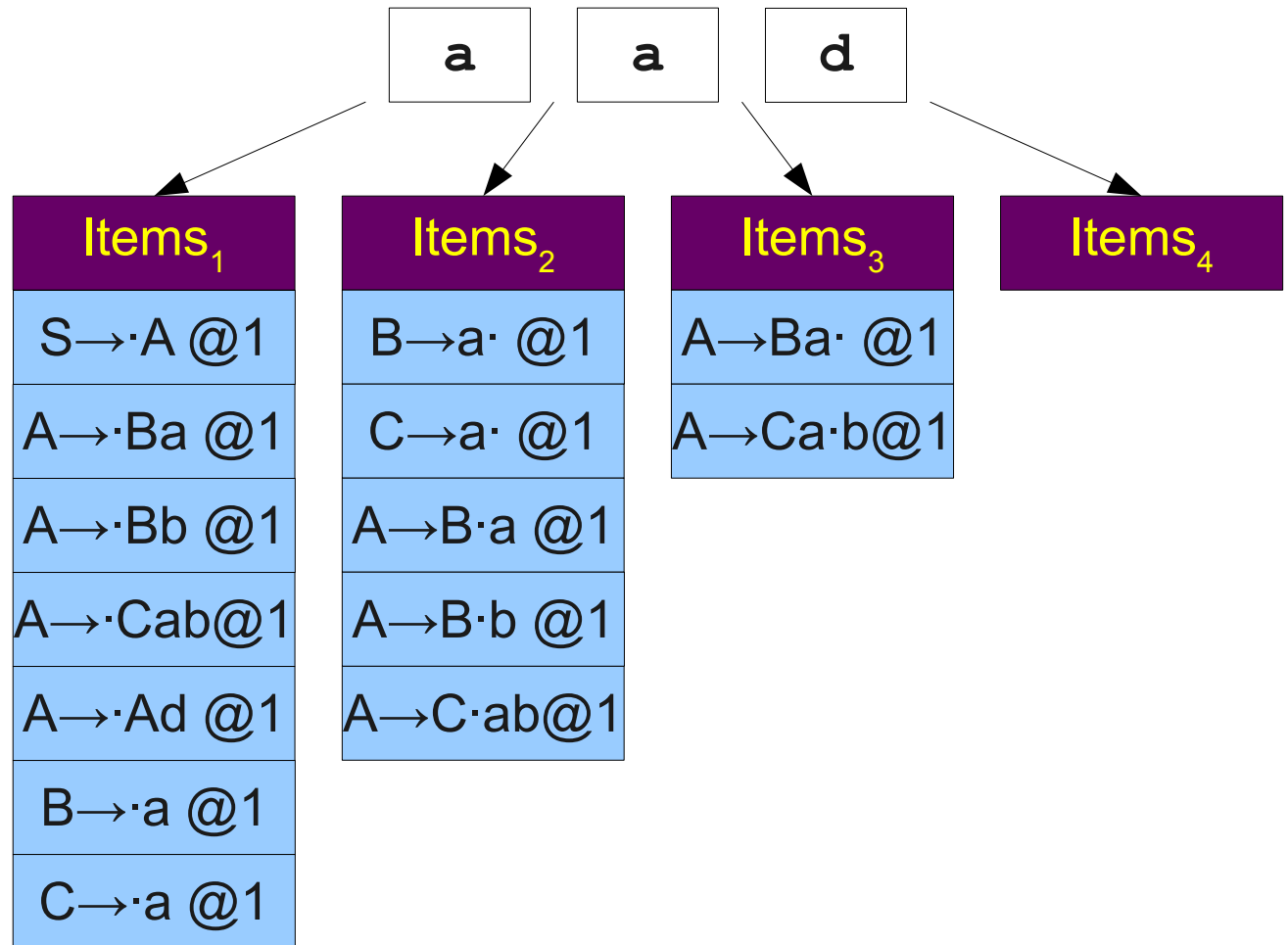

$S \rightarrow A$
 $A \rightarrow Ba$
 $A \rightarrow Bb$
 $A \rightarrow Cab$
 $A \rightarrow Ad$
 $B \rightarrow a$
 $C \rightarrow a$

Earley Parsing

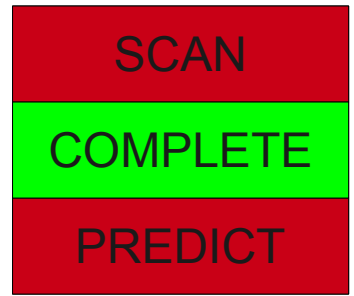

$B_{1-2} \rightarrow a_{1-2}$
 $C_{1-2} \rightarrow a_{1-2}$

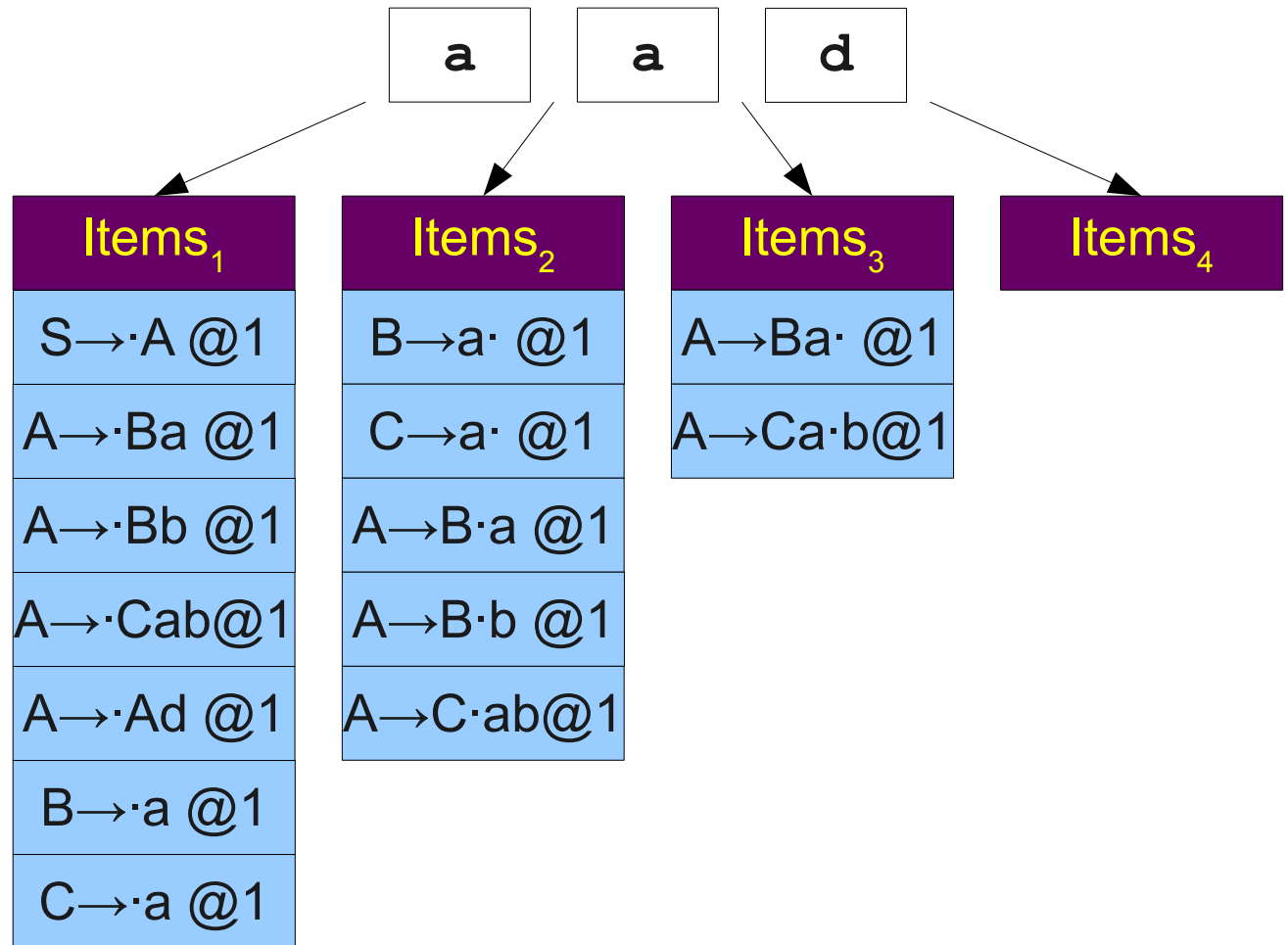

$S \rightarrow A$
 $A \rightarrow Ba$
 $A \rightarrow Bb$
 $A \rightarrow Cab$
 $A \rightarrow Ad$
 $B \rightarrow a$
 $C \rightarrow a$

Earley Parsing

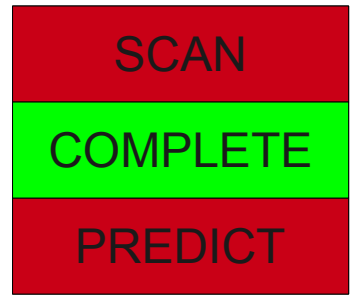

$B_{1-2} \rightarrow a_{1-2}$
 $C_{1-2} \rightarrow a_{1-2}$
 $A_{1-3} \rightarrow B_{1-2} a_{2-3}$

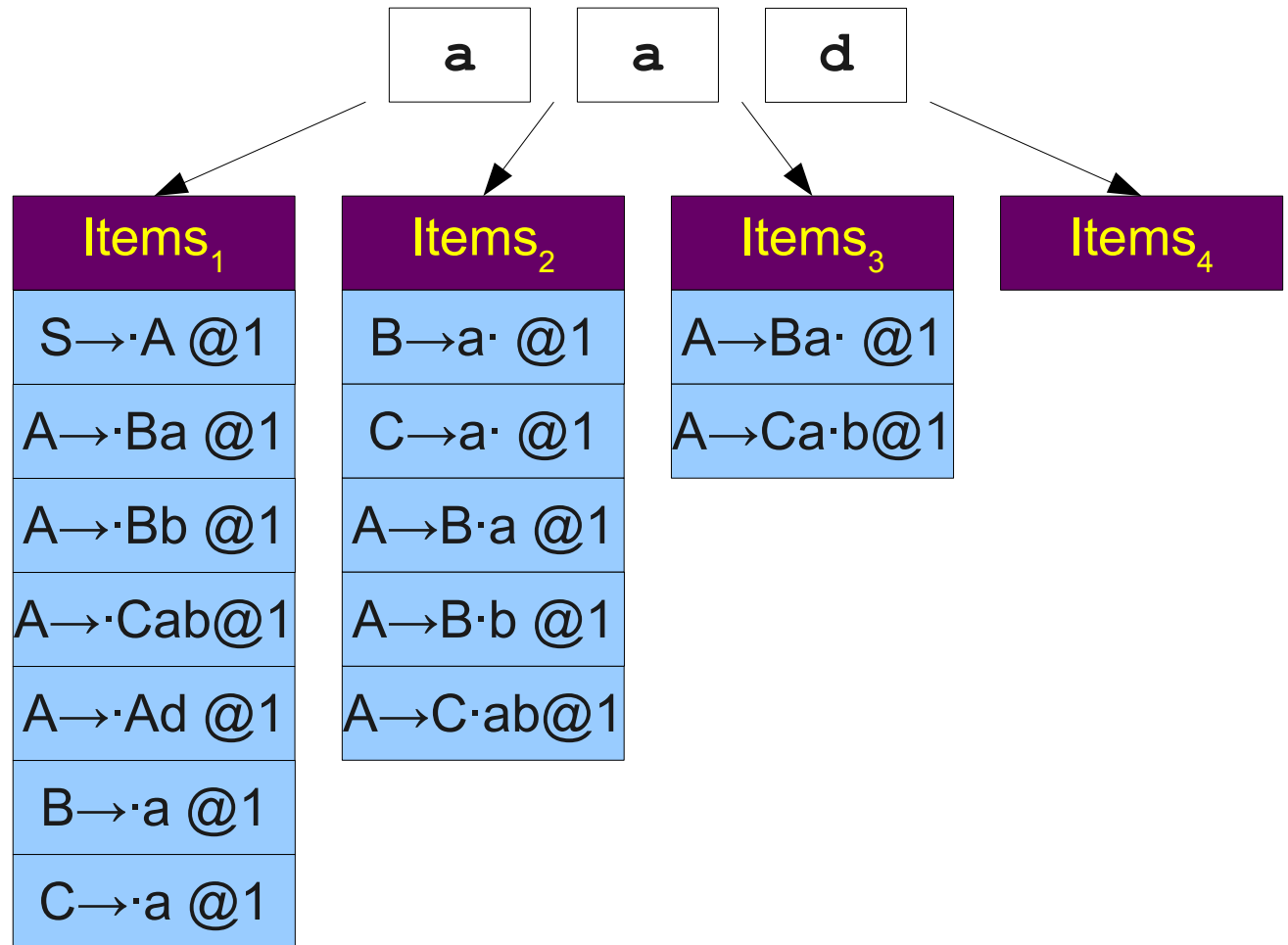

$S \rightarrow A$
 $A \rightarrow Ba$
 $A \rightarrow Bb$
 $A \rightarrow Cab$
 $A \rightarrow Ad$
 $B \rightarrow a$
 $C \rightarrow a$

Earley Parsing

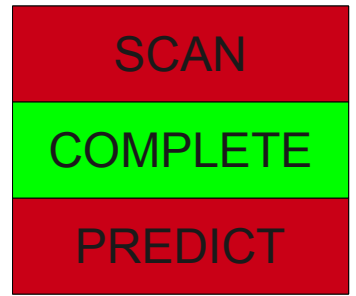

$B_{1-2} \rightarrow a_{1-2}$
 $C_{1-2} \rightarrow a_{1-2}$
 $A_{1-3} \rightarrow B_{1-2} a_{2-3}$

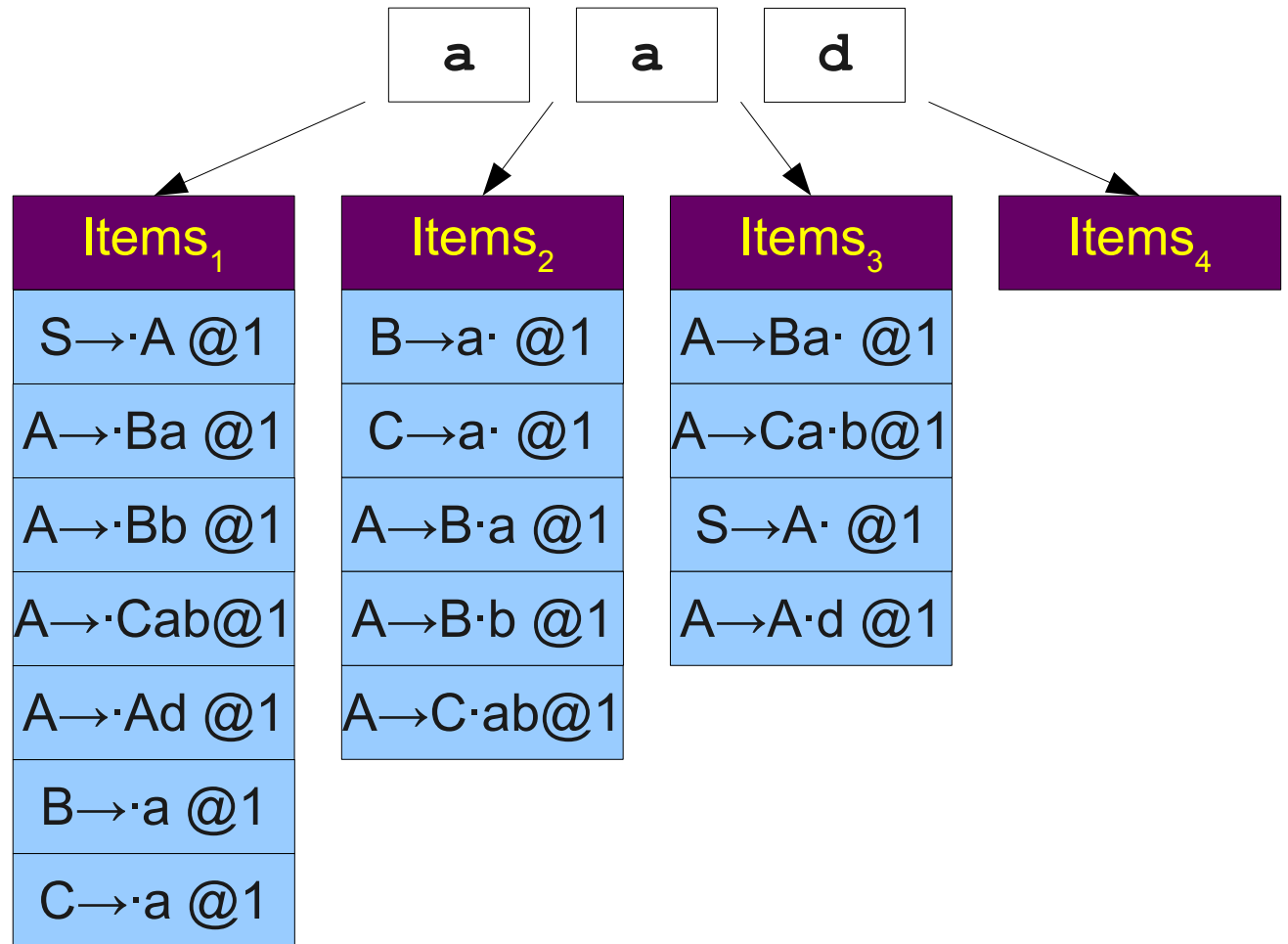

$S \rightarrow A$
 $A \rightarrow Ba$
 $A \rightarrow Bb$
 $A \rightarrow Cab$
 $A \rightarrow Ad$
 $B \rightarrow a$
 $C \rightarrow a$

Earley Parsing

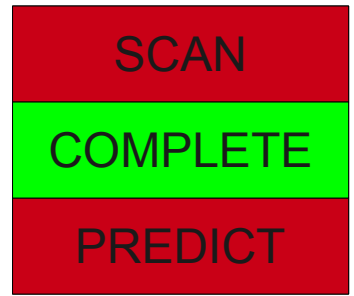

$B_{1-2} \rightarrow a_{1-2}$
 $C_{1-2} \rightarrow a_{1-2}$
 $A_{1-3} \rightarrow B_{1-2} a_{2-3}$
 $S_{1-3} \rightarrow A_{1-3}$

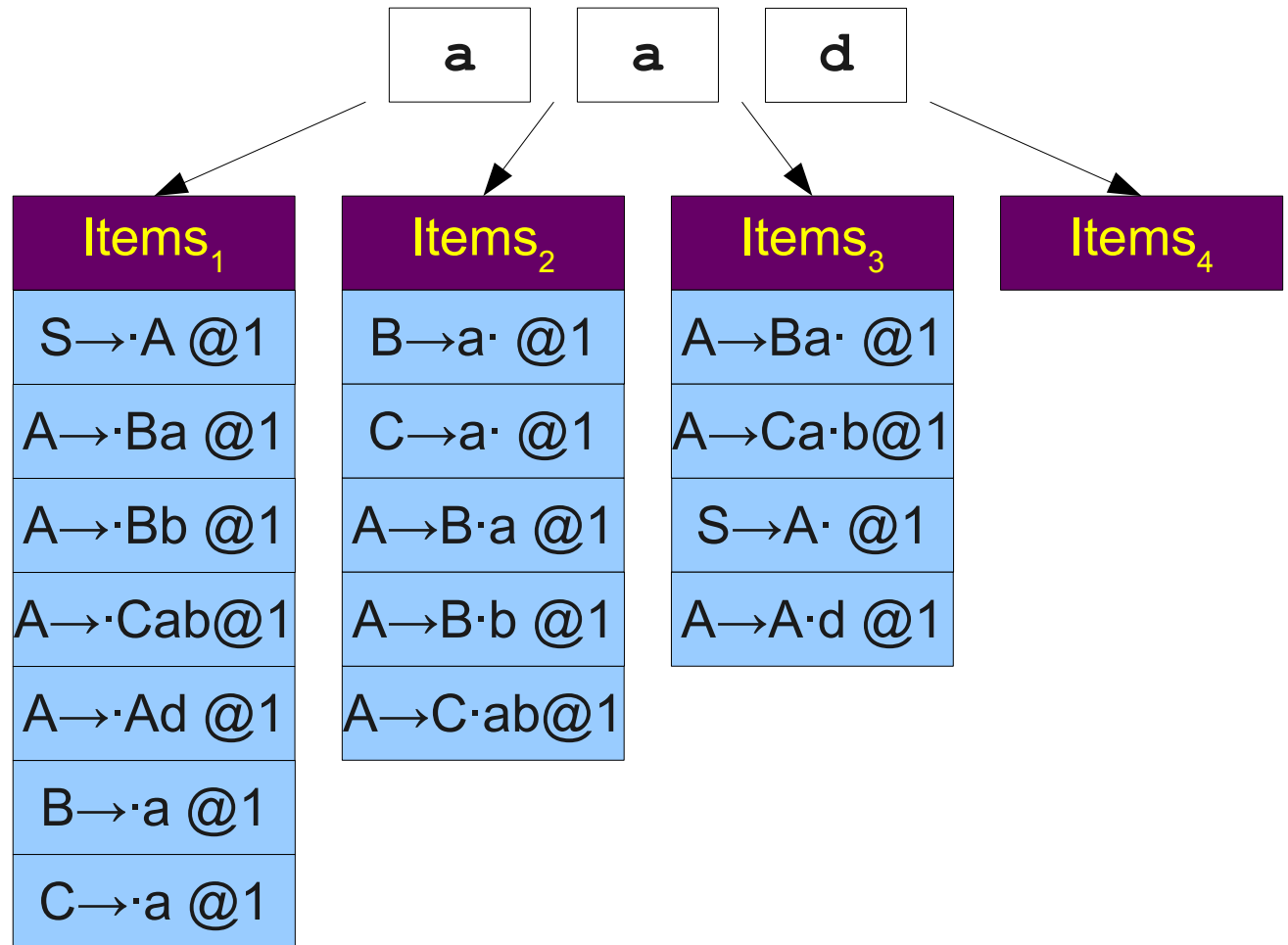

$S \rightarrow A$
 $A \rightarrow Ba$
 $A \rightarrow Bb$
 $A \rightarrow Cab$
 $A \rightarrow Ad$
 $B \rightarrow a$
 $C \rightarrow a$

Earley Parsing

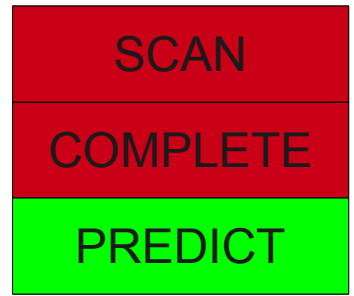

$B_{1-2} \rightarrow a_{1-2}$
 $C_{1-2} \rightarrow a_{1-2}$
 $A_{1-3} \rightarrow B_{1-2} a_{2-3}$
 $S_{1-3} \rightarrow A_{1-3}$

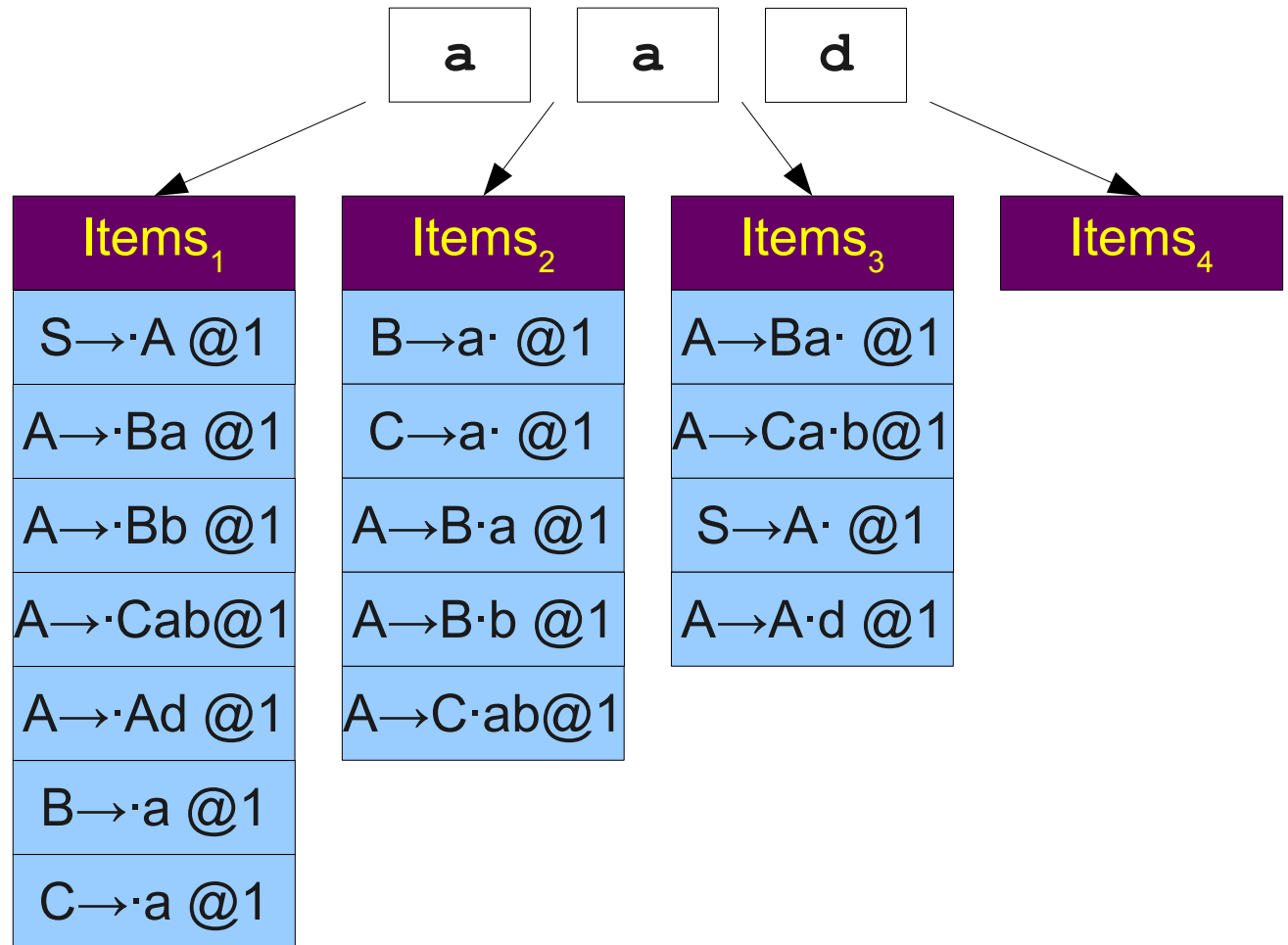

$S \rightarrow A$
 $A \rightarrow Ba$
 $A \rightarrow Bb$
 $A \rightarrow Cab$
 $A \rightarrow Ad$
 $B \rightarrow a$
 $C \rightarrow a$

Earley Parsing



$B_{1-2} \rightarrow a_{1-2}$
 $C_{1-2} \rightarrow a_{1-2}$
 $A_{1-3} \rightarrow B_{1-2} a_{2-3}$
 $S_{1-3} \rightarrow A_{1-3}$

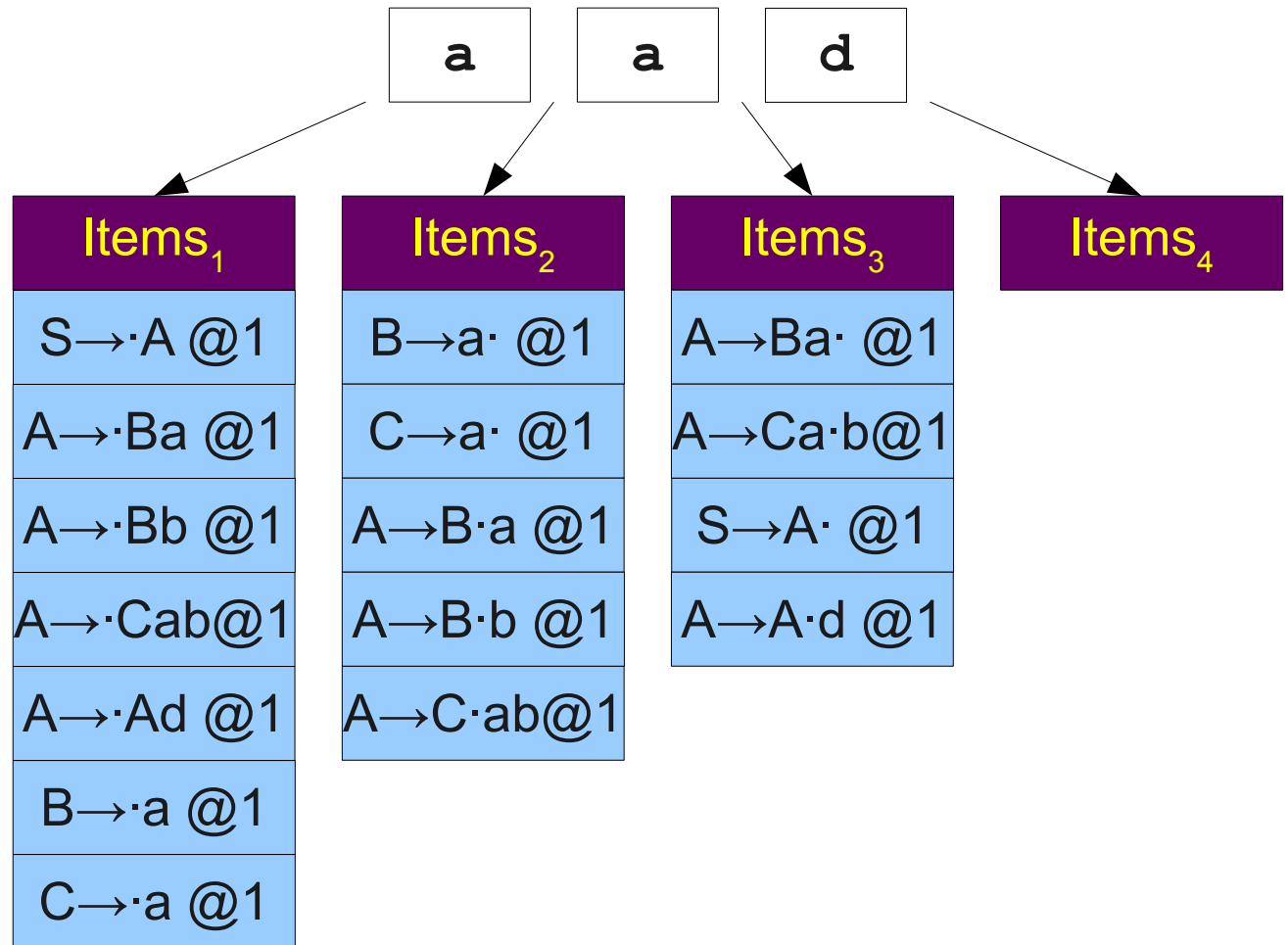

$S \rightarrow A$
 $A \rightarrow Ba$
 $A \rightarrow Bb$
 $A \rightarrow Cab$
 $A \rightarrow Ad$
 $B \rightarrow a$
 $C \rightarrow a$

Earley Parsing



$B_{1-2} \rightarrow a_{1-2}$
 $C_{1-2} \rightarrow a_{1-2}$
 $A_{1-3} \rightarrow B_{1-2} a_{2-3}$
 $S_{1-3} \rightarrow A_{1-3}$

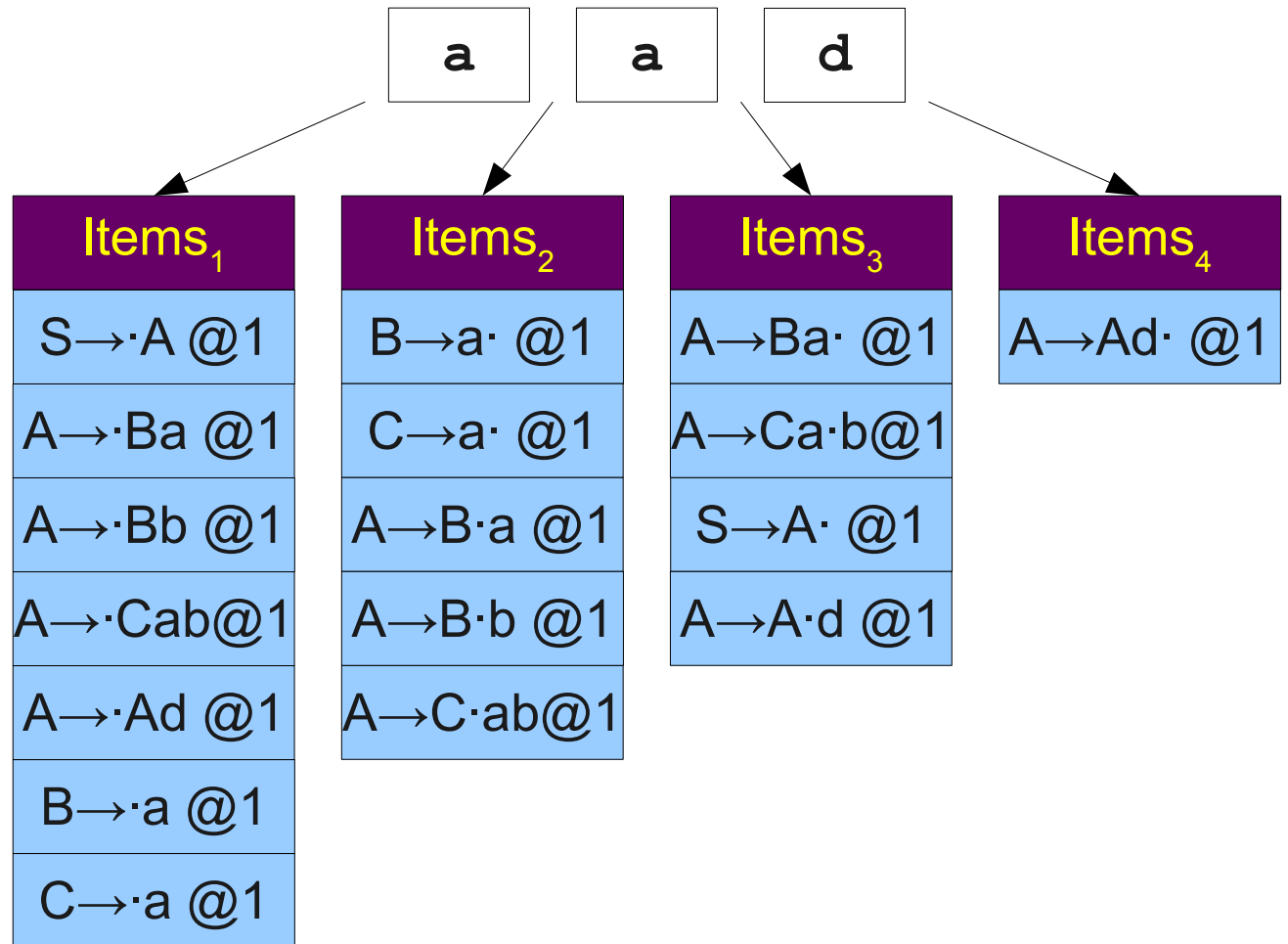

$S \rightarrow A$
 $A \rightarrow Ba$
 $A \rightarrow Bb$
 $A \rightarrow Cab$
 $A \rightarrow Ad$
 $B \rightarrow a$
 $C \rightarrow a$

Earley Parsing

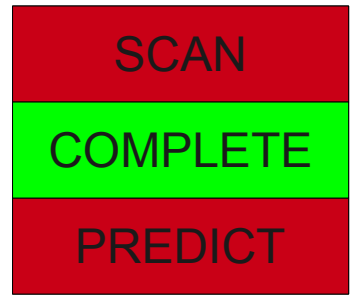

$B_{1-2} \rightarrow a_{1-2}$
 $C_{1-2} \rightarrow a_{1-2}$
 $A_{1-3} \rightarrow B_{1-2} a_{2-3}$
 $S_{1-3} \rightarrow A_{1-3}$

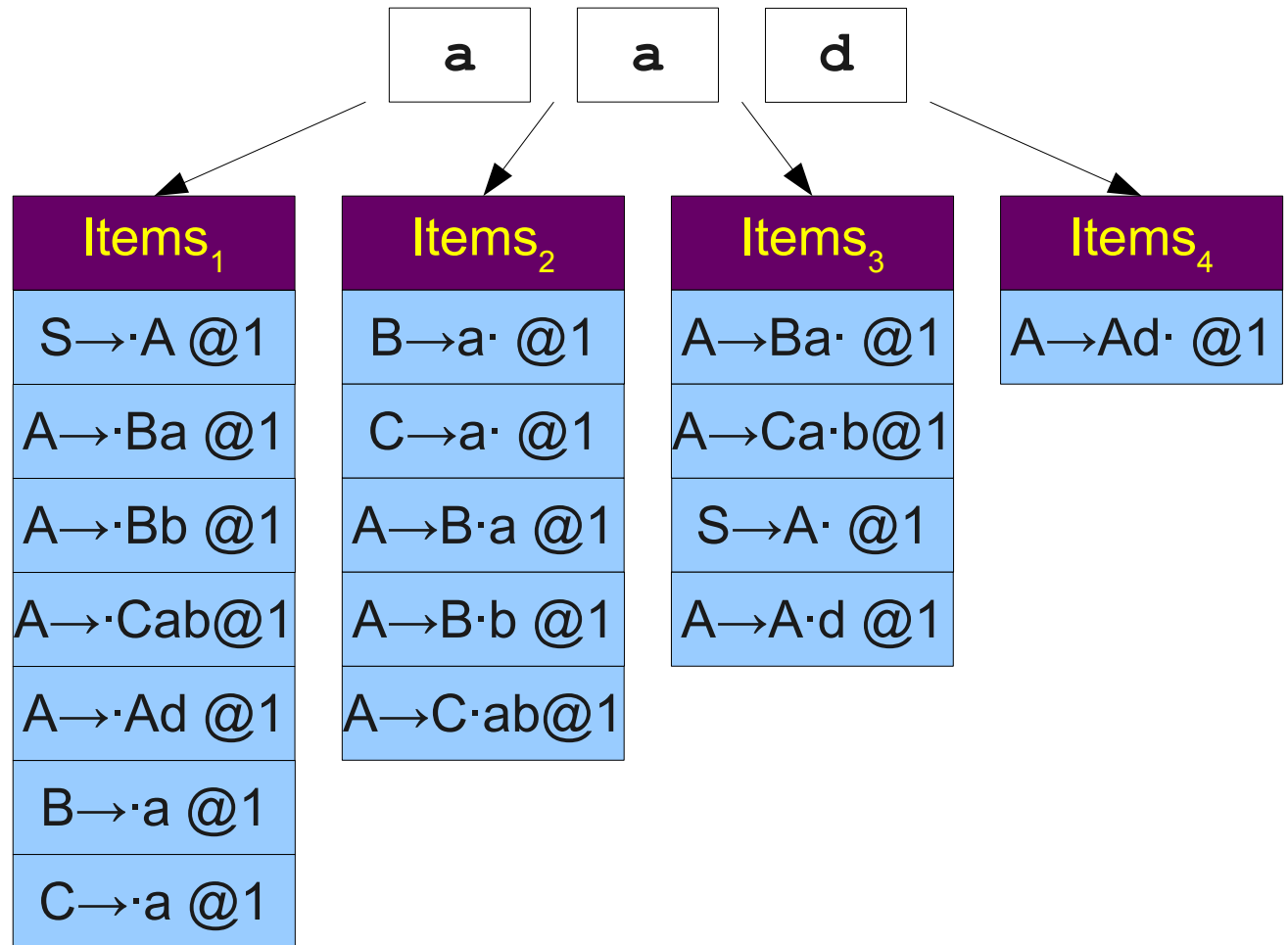

$S \rightarrow A$
 $A \rightarrow Ba$
 $A \rightarrow Bb$
 $A \rightarrow Cab$
 $A \rightarrow Ad$
 $B \rightarrow a$
 $C \rightarrow a$

Earley Parsing

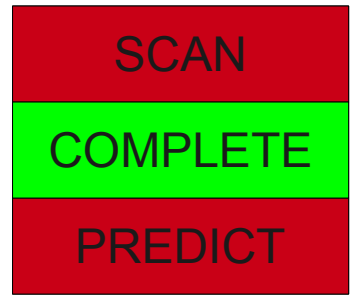

$B_{1-2} \rightarrow a_{1-2}$
 $C_{1-2} \rightarrow a_{1-2}$
 $A_{1-3} \rightarrow B_{1-2} a_{2-3}$
 $S_{1-3} \rightarrow A_{1-3}$
 $A_{1-4} \rightarrow A_{1-3} d_{3-4}$

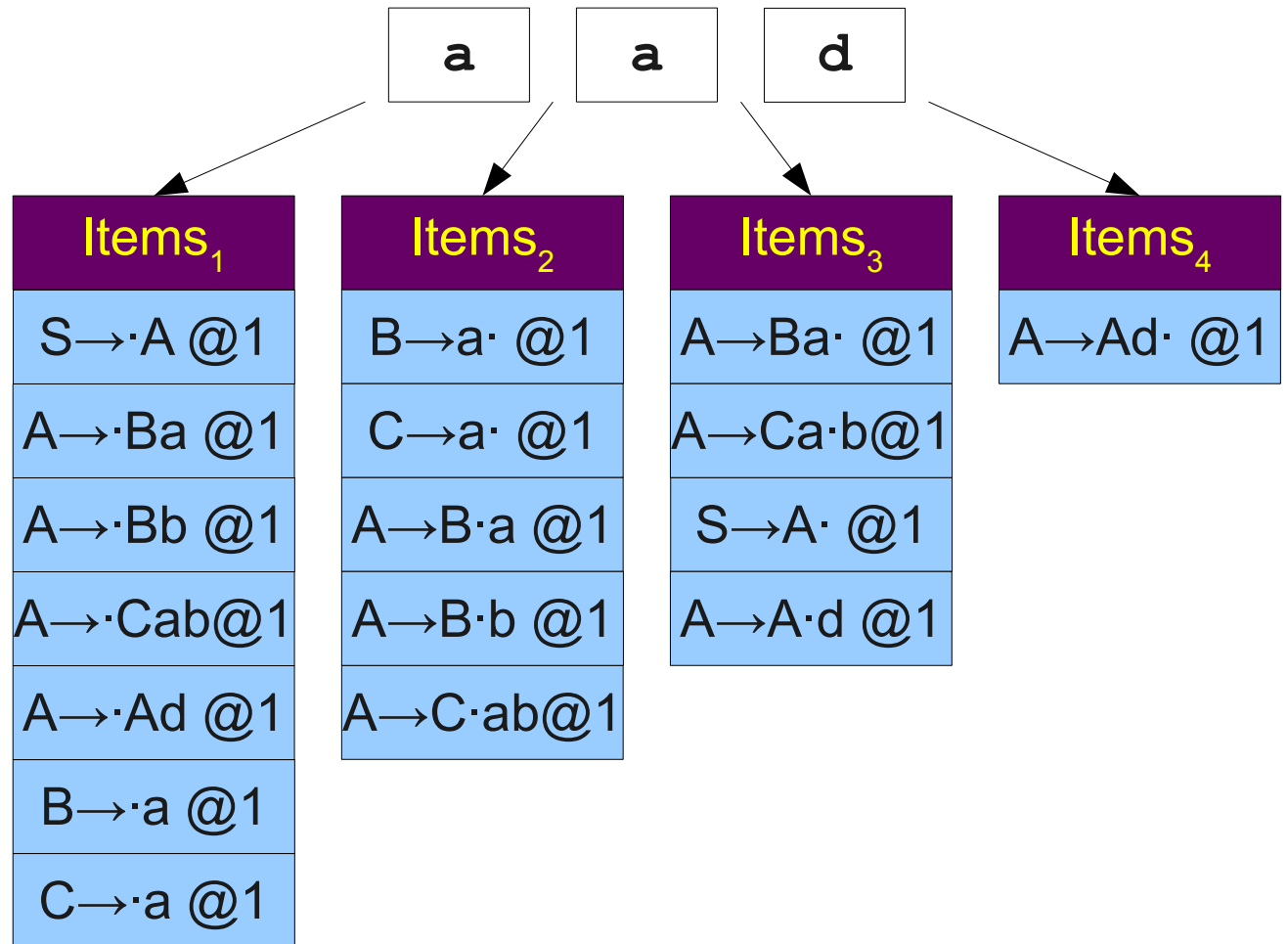

$S \rightarrow A$
 $A \rightarrow Ba$
 $A \rightarrow Bb$
 $A \rightarrow Cab$
 $A \rightarrow Ad$
 $B \rightarrow a$
 $C \rightarrow a$

Earley Parsing

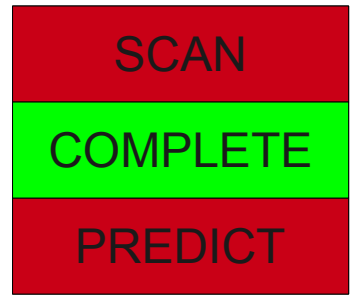

$B_{1-2} \rightarrow a_{1-2}$
 $C_{1-2} \rightarrow a_{1-2}$
 $A_{1-3} \rightarrow B_{1-2} a_{2-3}$
 $S_{1-3} \rightarrow A_{1-3}$
 $A_{1-4} \rightarrow A_{1-3} d_{3-4}$

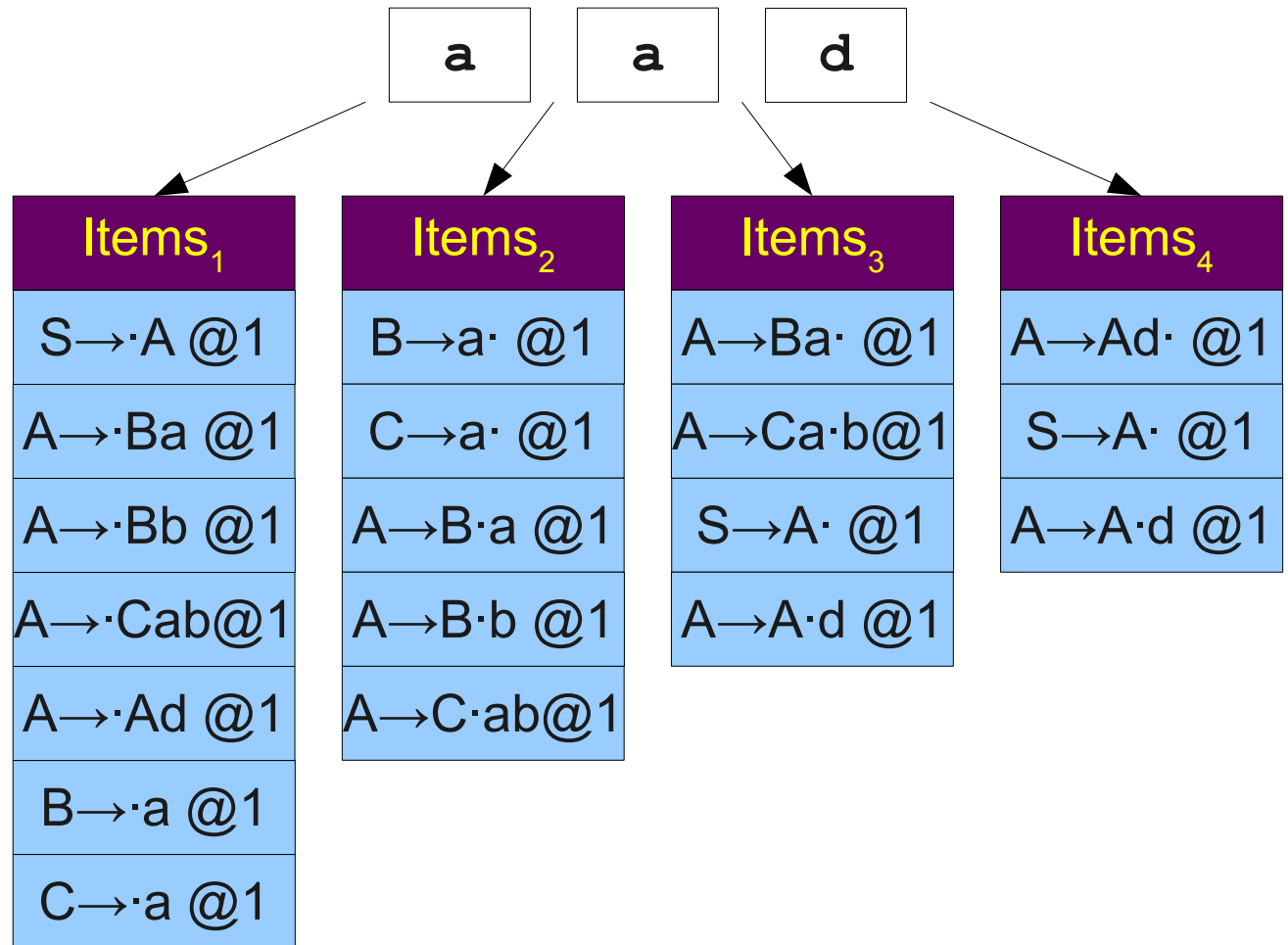

$S \rightarrow A$
 $A \rightarrow Ba$
 $A \rightarrow Bb$
 $A \rightarrow Cab$
 $A \rightarrow Ad$
 $B \rightarrow a$
 $C \rightarrow a$

Earley Parsing

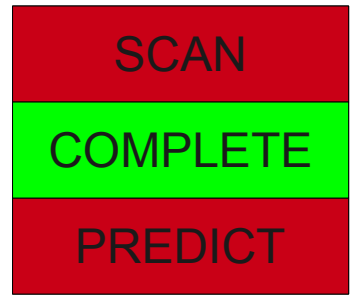

$B_{1-2} \rightarrow a_{1-2}$
 $C_{1-2} \rightarrow a_{1-2}$
 $A_{1-3} \rightarrow B_{1-2} a_{2-3}$
 $S_{1-3} \rightarrow A_{1-3}$
 $A_{1-4} \rightarrow A_{1-3} d_{3-4}$
 $S_{1-4} \rightarrow A_{1-4}$

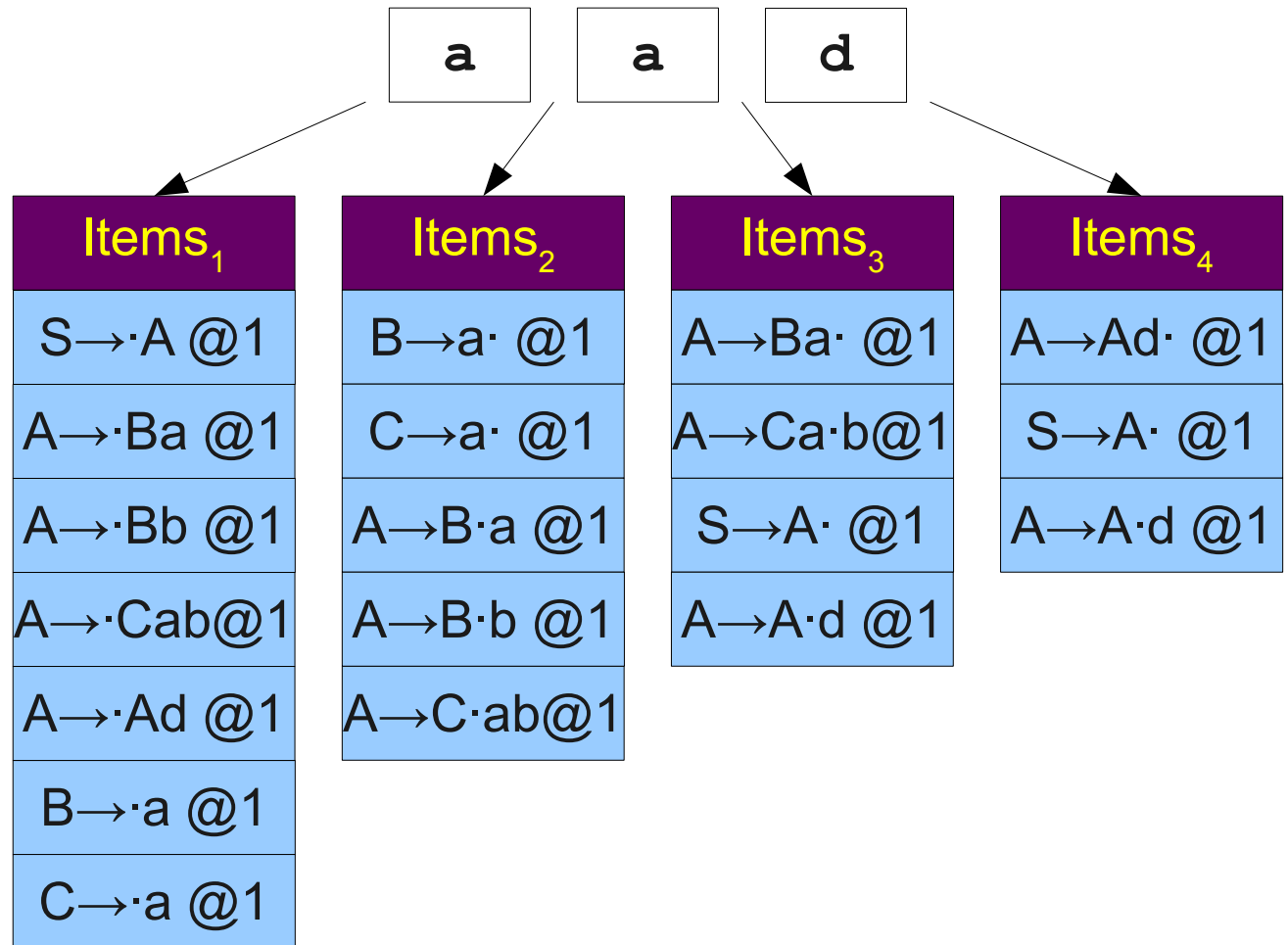

$S \rightarrow A$
 $A \rightarrow Ba$
 $A \rightarrow Bb$
 $A \rightarrow Cab$
 $A \rightarrow Ad$
 $B \rightarrow a$
 $C \rightarrow a$

Earley Parsing

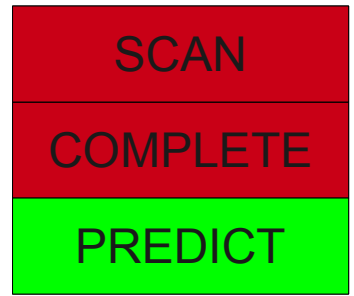

$B_{1-2} \rightarrow a_{1-2}$
 $C_{1-2} \rightarrow a_{1-2}$
 $A_{1-3} \rightarrow B_{1-2} a_{2-3}$
 $S_{1-3} \rightarrow A_{1-3}$
 $A_{1-4} \rightarrow A_{1-3} d_{3-4}$
 $S_{1-4} \rightarrow A_{1-4}$

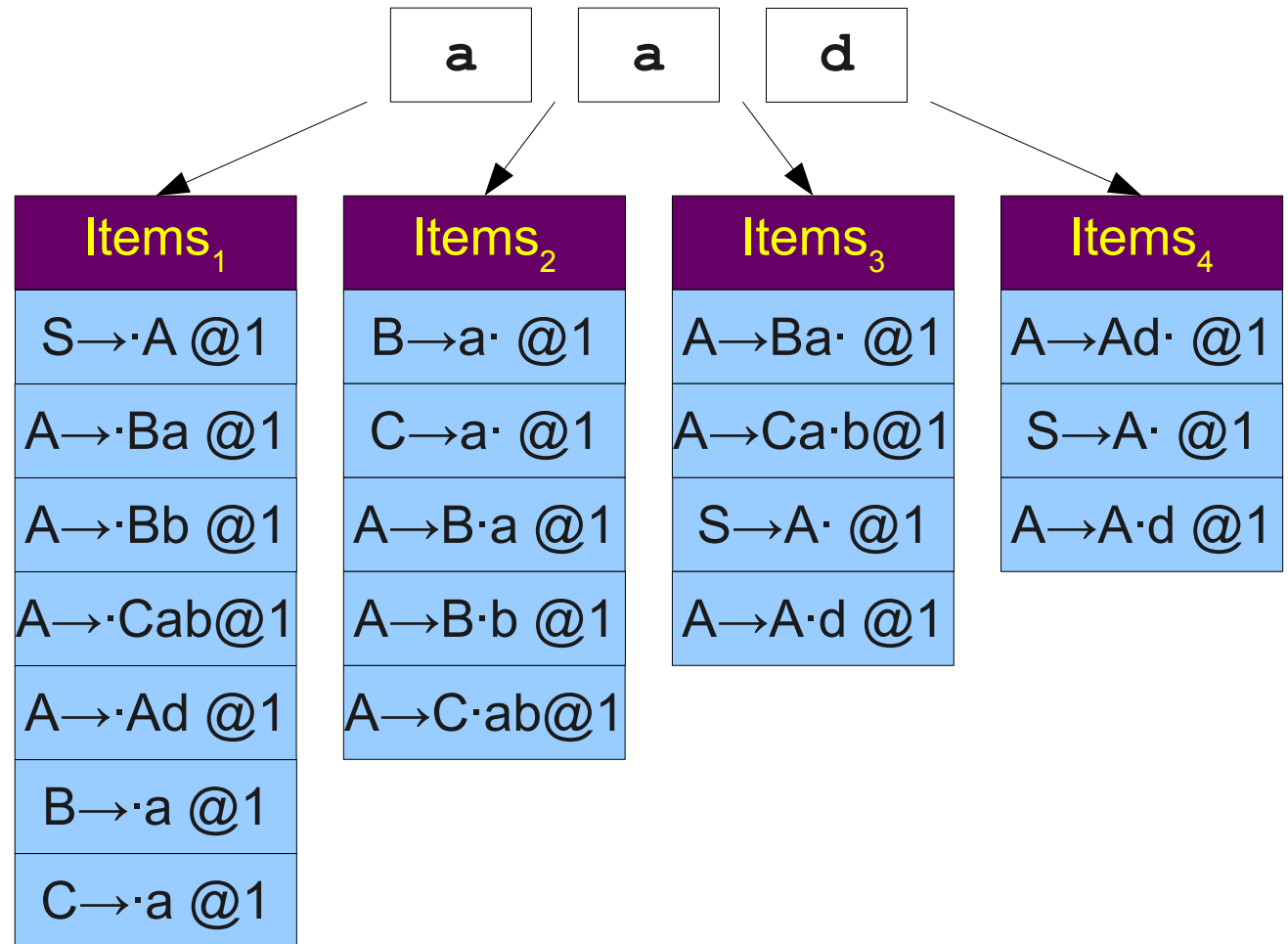

$S \rightarrow A$
 $A \rightarrow Ba$
 $A \rightarrow Bb$
 $A \rightarrow Cab$
 $A \rightarrow Ad$
 $B \rightarrow a$
 $C \rightarrow a$

Earley Parsing

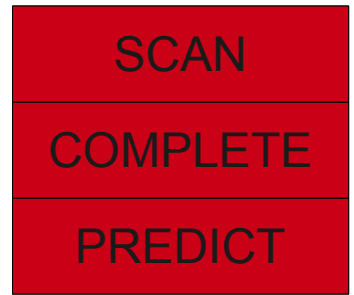

$B_{1-2} \rightarrow a_{1-2}$
 $C_{1-2} \rightarrow a_{1-2}$
 $A_{1-3} \rightarrow B_{1-2} a_{2-3}$
 $S_{1-3} \rightarrow A_{1-3}$
 $A_{1-4} \rightarrow A_{1-3} d_{3-4}$
 $S_{1-4} \rightarrow A_{1-4}$

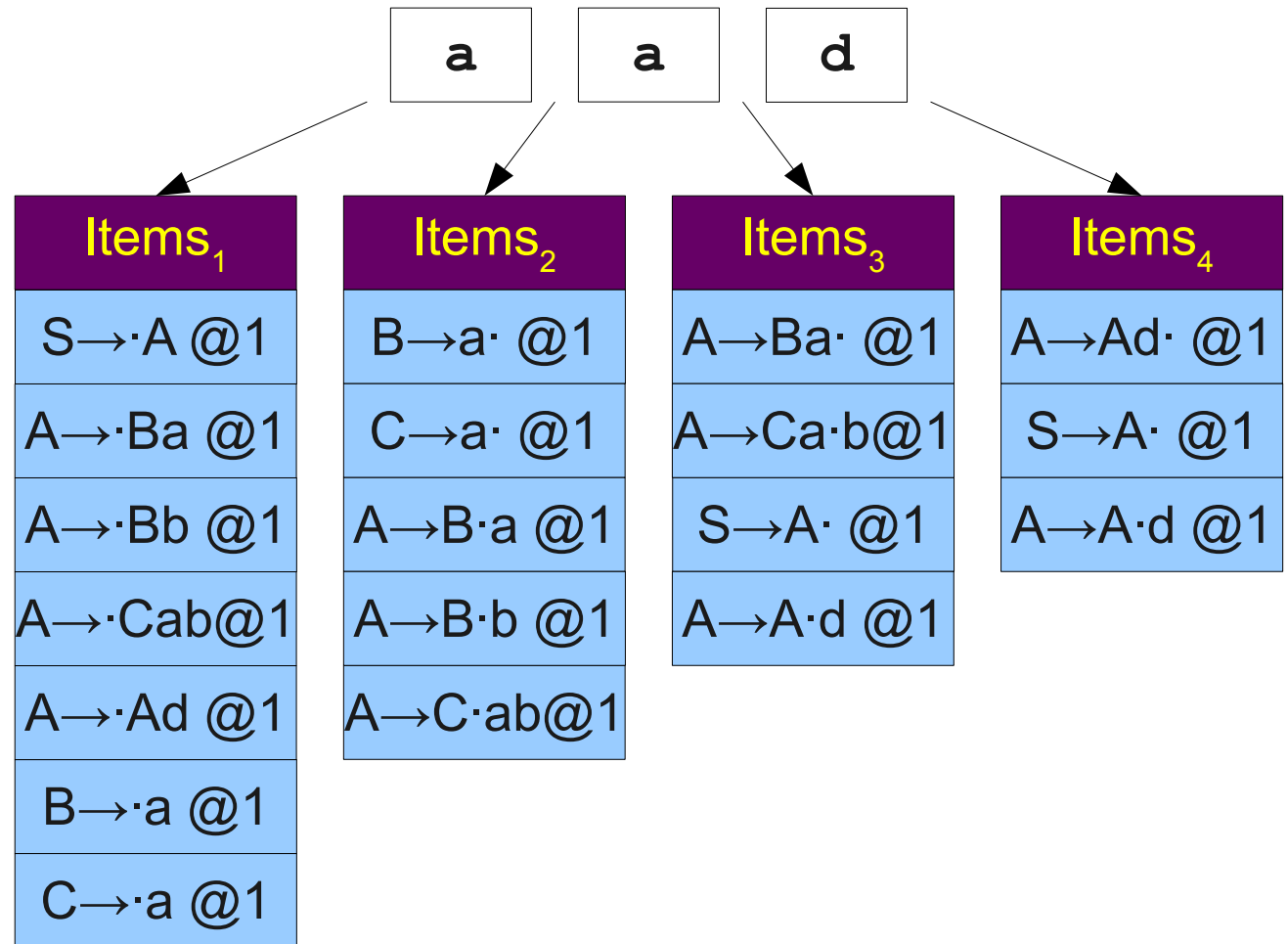

$S \rightarrow A$
 $A \rightarrow Ba$
 $A \rightarrow Bb$
 $A \rightarrow Cab$
 $A \rightarrow Ad$
 $B \rightarrow a$
 $C \rightarrow a$

Earley Parsing

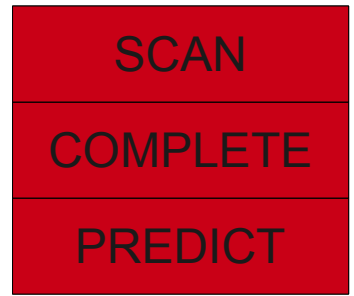

$B_{1-2} \rightarrow a_{1-2}$
 $C_{1-2} \rightarrow a_{1-2}$
 $A_{1-3} \rightarrow B_{1-2} a_{2-3}$
 $S_{1-3} \rightarrow A_{1-3}$
 $A_{1-4} \rightarrow A_{1-3} d_{3-4}$
 $S_{1-4} \rightarrow A_{1-4}$

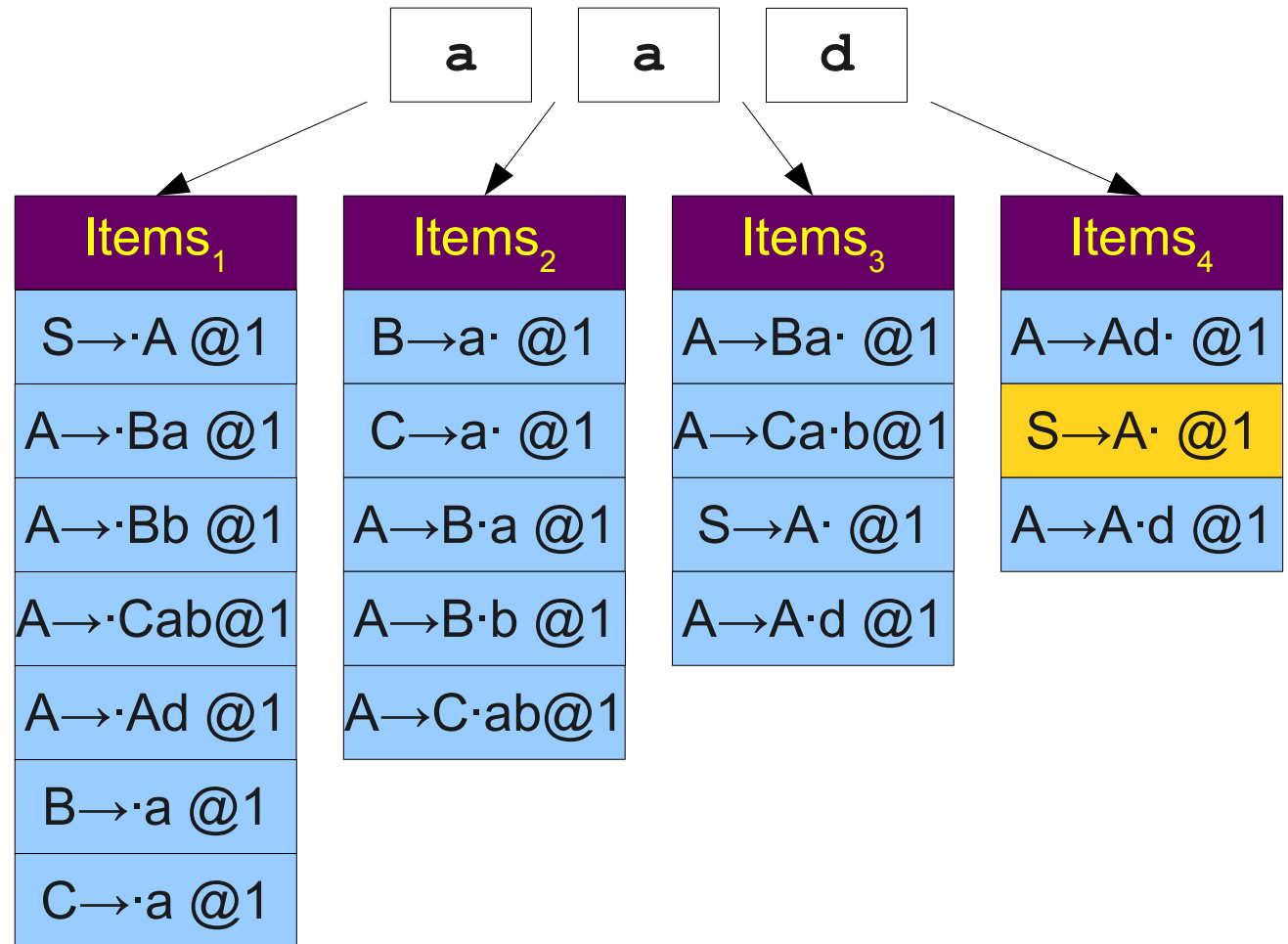

$S \rightarrow A$
 $A \rightarrow Ba$
 $A \rightarrow Bb$
 $A \rightarrow Cab$
 $A \rightarrow Ad$
 $B \rightarrow a$
 $C \rightarrow a$

Earley Parsing

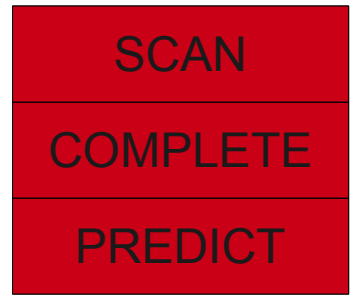

$B_{1-2} \rightarrow a_{1-2}$
 $C_{1-2} \rightarrow a_{1-2}$
 $A_{1-3} \rightarrow B_{1-2} a_{2-3}$
 $S_{1-3} \rightarrow A_{1-3}$
 $A_{1-4} \rightarrow A_{1-3} d_{3-4}$
 $S_{1-4} \rightarrow A_{1-4}$
 $S \rightarrow S_{1-4}$

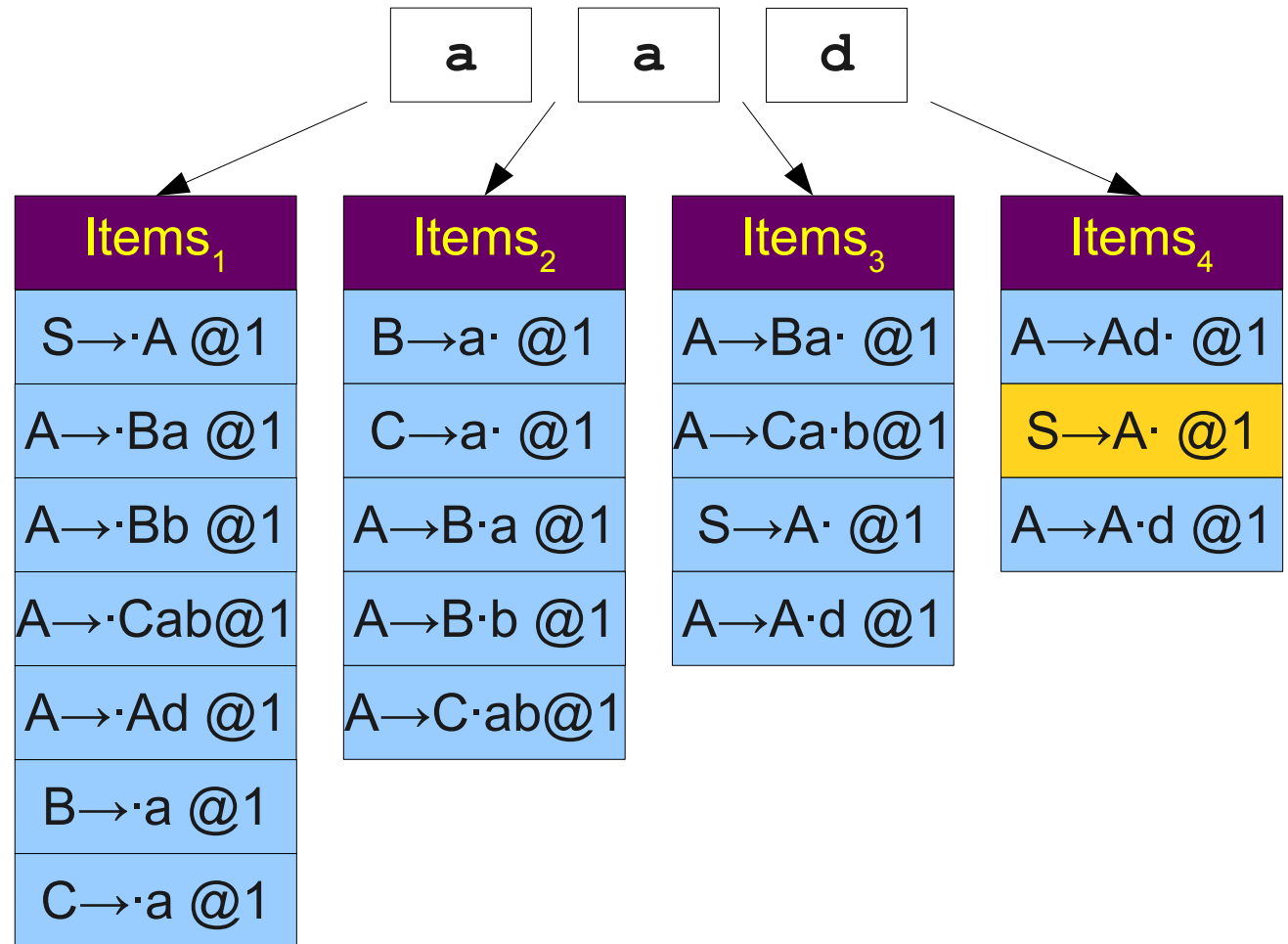

Cleaning our Grammar

$$B_{1-2} \rightarrow a_{1-2}$$

$$C_{1-2} \rightarrow a_{1-2}$$

$$A_{1-3} \rightarrow B_{1-2} a_{2-3}$$

$$S_{1-3} \rightarrow A_{1-3}$$

$$A_{1-4} \rightarrow A_{1-3} d_{3-4}$$

$$S_{1-4} \rightarrow A_{1-4}$$

$$S \rightarrow S_{1-4}$$

Cleaning our Grammar

S

$$B_{1-2} \rightarrow a_{1-2}$$

$$C_{1-2} \rightarrow a_{1-2}$$

$$A_{1-3} \rightarrow B_{1-2} a_{2-3}$$

$$S_{1-3} \rightarrow A_{1-3}$$

$$A_{1-4} \rightarrow A_{1-3} d_{3-4}$$

$$S_{1-4} \rightarrow A_{1-4}$$

$$S \rightarrow S_{1-4}$$

Cleaning our Grammar

$$B_{1-2} \rightarrow a_{1-2}$$

$$C_{1-2} \rightarrow a_{1-2}$$

$$A_{1-3} \rightarrow B_{1-2} a_{2-3}$$

$$S_{1-3} \rightarrow A_{1-3}$$

$$A_{1-4} \rightarrow A_{1-3} d_{3-4}$$

$$S_{1-4} \rightarrow A_{1-4}$$

$$S \rightarrow S_{1-4}$$

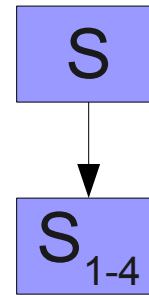

Cleaning our Grammar

$$B_{1-2} \rightarrow a_{1-2}$$

$$C_{1-2} \rightarrow a_{1-2}$$

$$A_{1-3} \rightarrow B_{1-2} a_{2-3}$$

$$S_{1-3} \rightarrow A_{1-3}$$

$$A_{1-4} \rightarrow A_{1-3} d_{3-4}$$

$$S_{1-4} \rightarrow A_{1-4}$$

$$S \rightarrow S_{1-4}$$

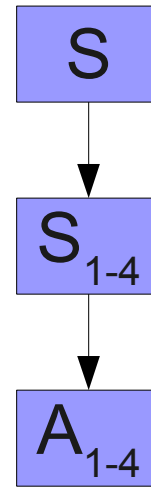

Cleaning our Grammar

$B_{1-2} \rightarrow a_{1-2}$
 $C_{1-2} \rightarrow a_{1-2}$
 $A_{1-3} \rightarrow B_{1-2} a_{2-3}$
 $S_{1-3} \rightarrow A_{1-3}$
 $A_{1-4} \rightarrow A_{1-3} d_{3-4}$
 $S_{1-4} \rightarrow A_{1-4}$
 $S \rightarrow S_{1-4}$

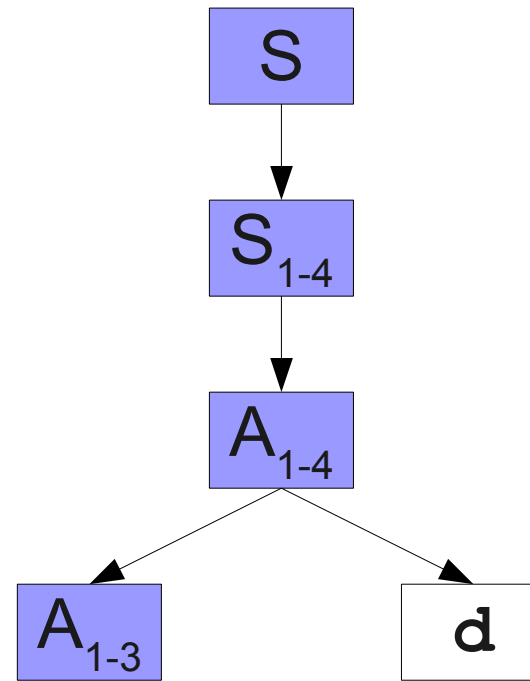

Cleaning our Grammar

$B_{1-2} \rightarrow a_{1-2}$
 $C_{1-2} \rightarrow a_{1-2}$
 $A_{1-3} \rightarrow B_{1-2} a_{2-3}$
 $S_{1-3} \rightarrow A_{1-3}$
 $A_{1-4} \rightarrow A_{1-3} d_{3-4}$
 $S_{1-4} \rightarrow A_{1-4}$
 $S \rightarrow S_{1-4}$

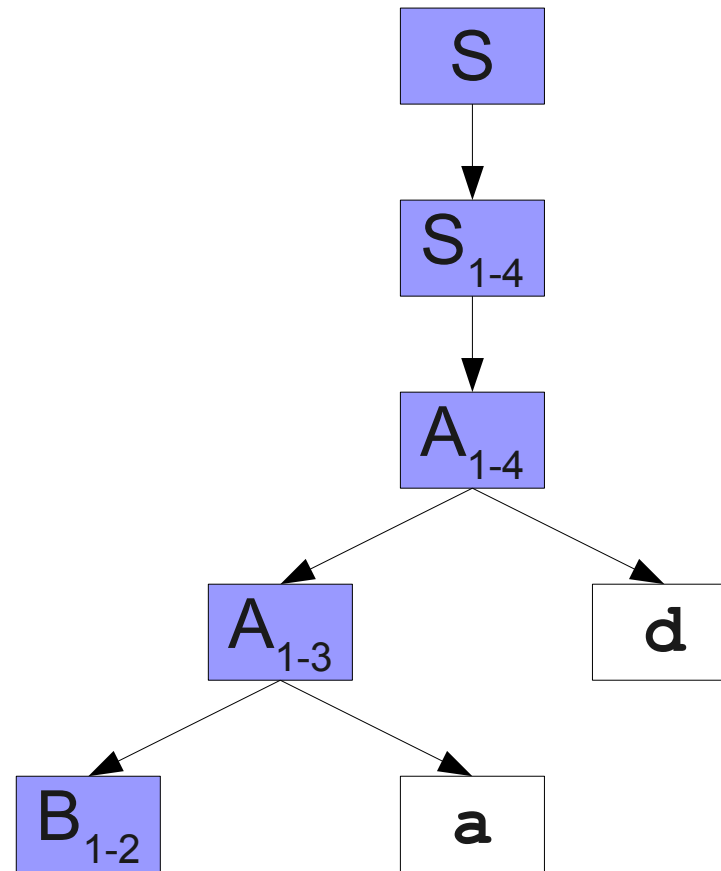

Cleaning our Grammar

$B_{1-2} \rightarrow a_{1-2}$
 $C_{1-2} \rightarrow a_{1-2}$
 $A_{1-3} \rightarrow B_{1-2} a_{2-3}$
 $S_{1-3} \rightarrow A_{1-3}$
 $A_{1-4} \rightarrow A_{1-3} d_{3-4}$
 $S_{1-4} \rightarrow A_{1-4}$
 $S \rightarrow S_{1-4}$

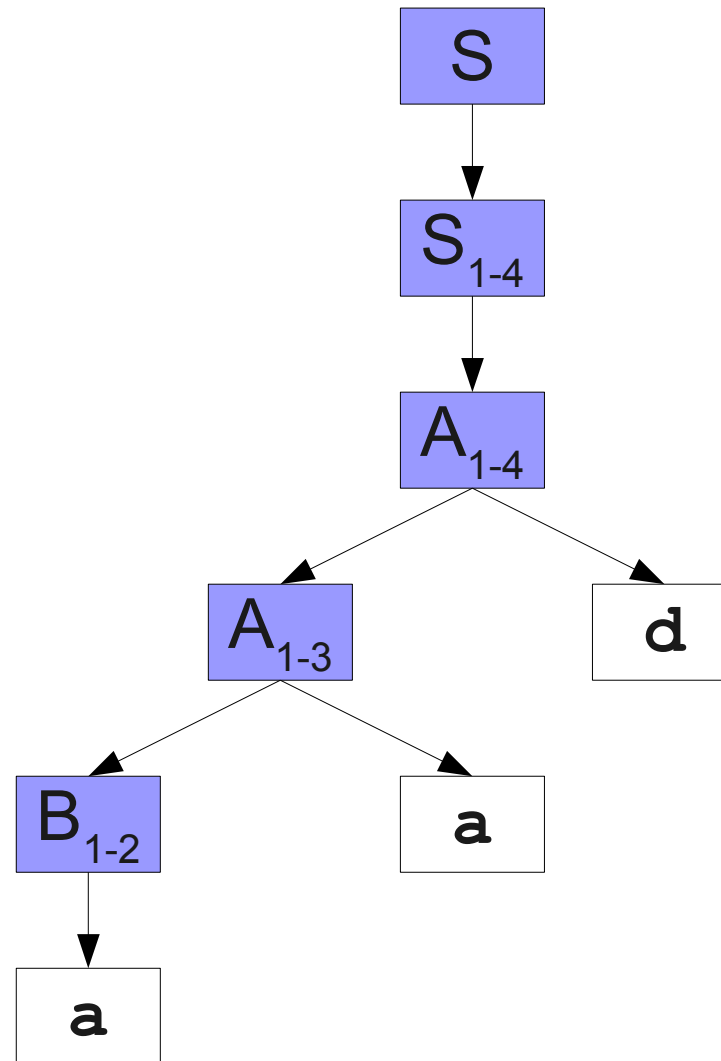

Cleaning our Grammar

$B_{1-2} \rightarrow a_{1-2}$

$C_{1-2} \rightarrow a_{1-2}$

$A_{1-3} \rightarrow B_{1-2} a_{2-3}$

$S_{1-3} \rightarrow A_{1-3}$

$A_{1-4} \rightarrow A_{1-3} d_{3-4}$

$S_{1-4} \rightarrow A_{1-4}$

$S \rightarrow S_{1-4}$

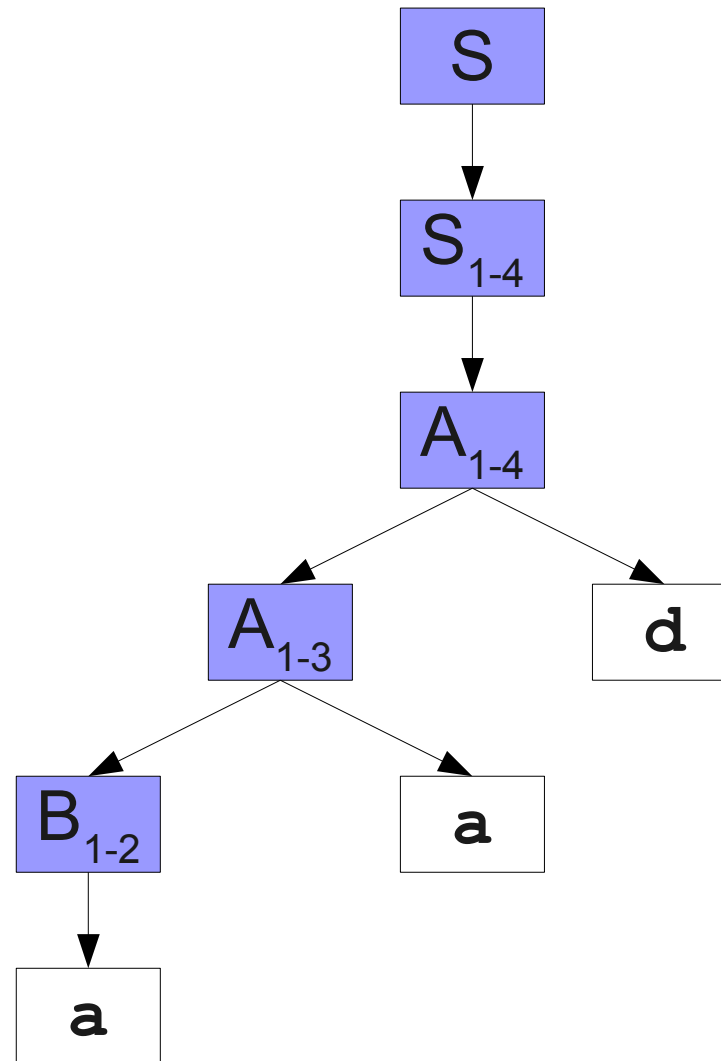

Cleaning our Grammar

$$B_{1-2} \rightarrow a_{1-2}$$

$$A_{1-3} \rightarrow B_{1-2} a_{2-3}$$

$$A_{1-4} \rightarrow A_{1-3} d_{3-4}$$

$$S_{1-4} \rightarrow A_{1-4}$$

$$S \rightarrow S_{1-4}$$

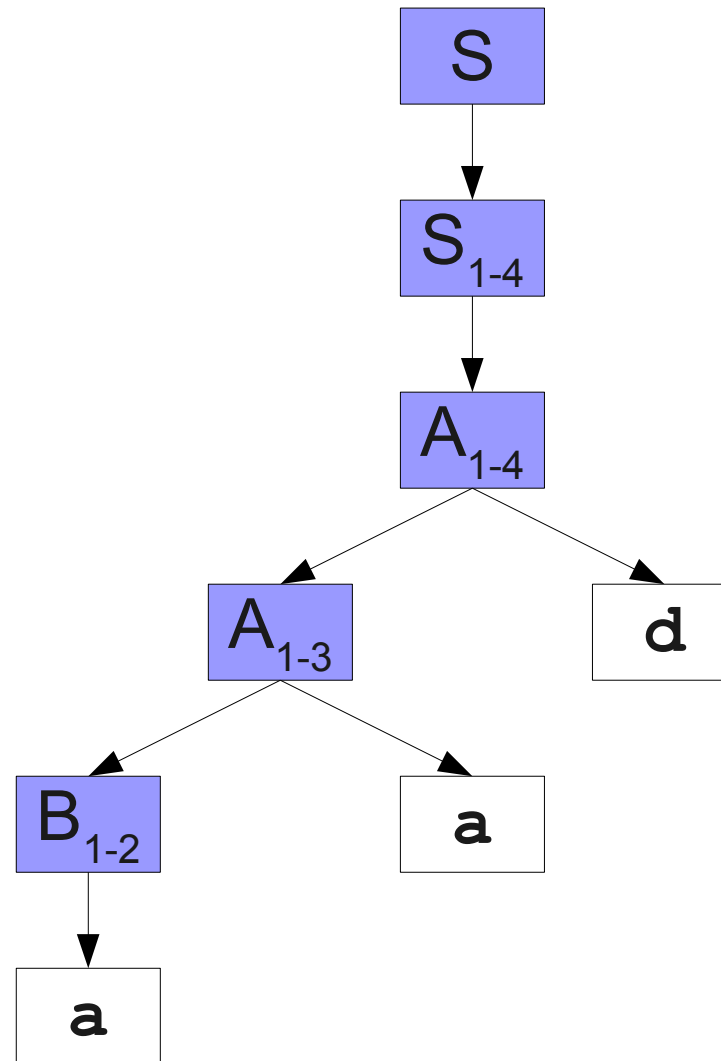

Cleaning our Grammar

$$B_{1-2} \rightarrow a_{1-2}$$

$$A_{1-3} \rightarrow B_{1-2} a_{2-3}$$

$$A_{1-4} \rightarrow A_{1-3} d_{3-4}$$

$$S_{1-4} \rightarrow A_{1-4}$$

$$S \rightarrow S_{1-4}$$



Cleaning a Parse Forest Grammar

- Remove all productions that can't be reached from the start symbol.
- Algorithm: (yet another) **fixed-point iteration**.
 - Set REACH = {S}
 - For each A in REACH, and for each nonterminal B where $A \rightarrow wBv$, add B to REACH.
- Remove all productions whose left-hand side is not in REACH.
- Can be made to run in time linear in the size of the grammar by encoding as a graph and doing a DFS.

Summary of Earley Parsing

- Parsing algorithm for arbitrary CFGs that, for any fixed grammar, runs quickly:
 - $O(n)$ for LR(k) grammars (after adding lookahead)
 - $O(n^2)$ for any unambiguous grammar.
 - $O(n^3)$ for any ambiguous grammar.
- Outputs a parse forest grammar of all possible parse trees.

Intersection Parsing

$S \rightarrow A$
 $A \rightarrow Ba$
 $A \rightarrow Bb$
 $A \rightarrow Cab$
 $A \rightarrow Ad$
 $B \rightarrow a$
 $C \rightarrow a$

An Observation

$S \rightarrow A$
 $A \rightarrow Ba$
 $A \rightarrow Bb$
 $A \rightarrow Cab$
 $A \rightarrow Ad$
 $B \rightarrow a$
 $C \rightarrow a$

An Observation

a	a	d
---	---	---

$S \rightarrow A$
 $A \rightarrow Ba$
 $A \rightarrow Bb$
 $A \rightarrow Cab$
 $A \rightarrow Ad$
 $B \rightarrow a$
 $C \rightarrow a$

An Observation

a

a

d

$S \rightarrow A$
 $A \rightarrow Ba$
 $A \rightarrow Bb$
 $A \rightarrow Cab$
 $A \rightarrow Ad$
 $B \rightarrow a$
 $C \rightarrow a$

An Observation

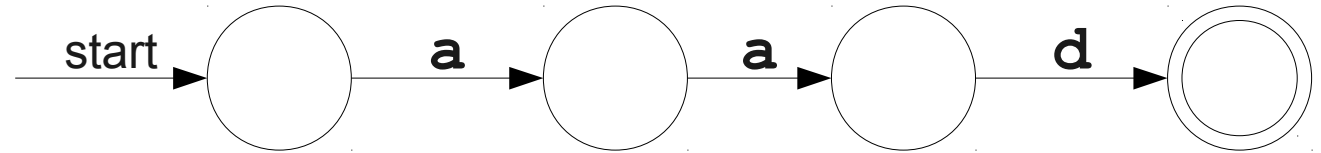

- $S \rightarrow A$
- $A \rightarrow Ba$
- $A \rightarrow Bb$
- $A \rightarrow Cab$
- $A \rightarrow Ad$
- $B \rightarrow a$
- $C \rightarrow a$

An Observation

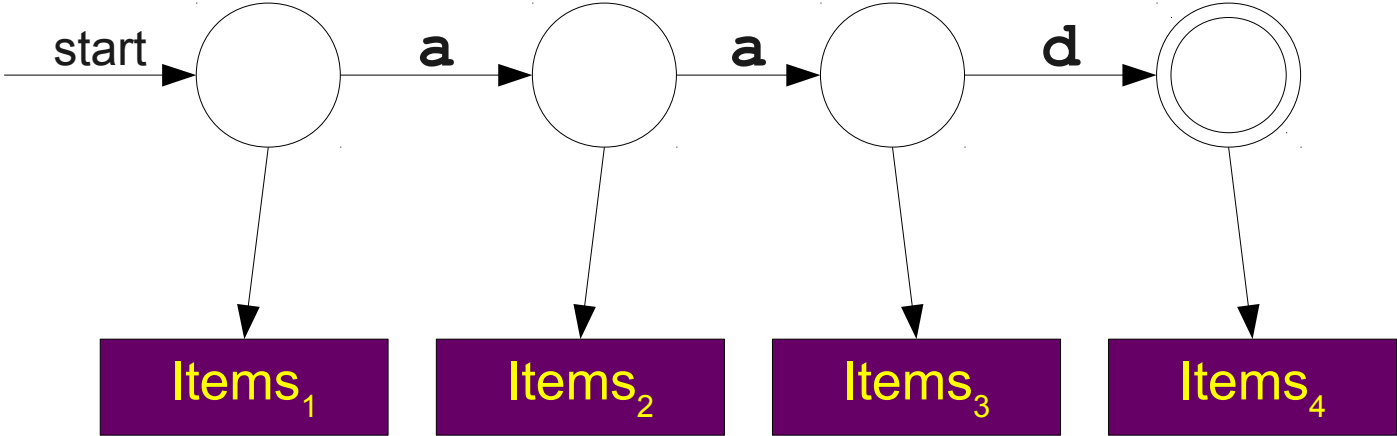

- $S \rightarrow A$
- $A \rightarrow Ba$
- $A \rightarrow Bb$
- $A \rightarrow Cab$
- $A \rightarrow Ad$
- $B \rightarrow a$
- $C \rightarrow a$

An Observation

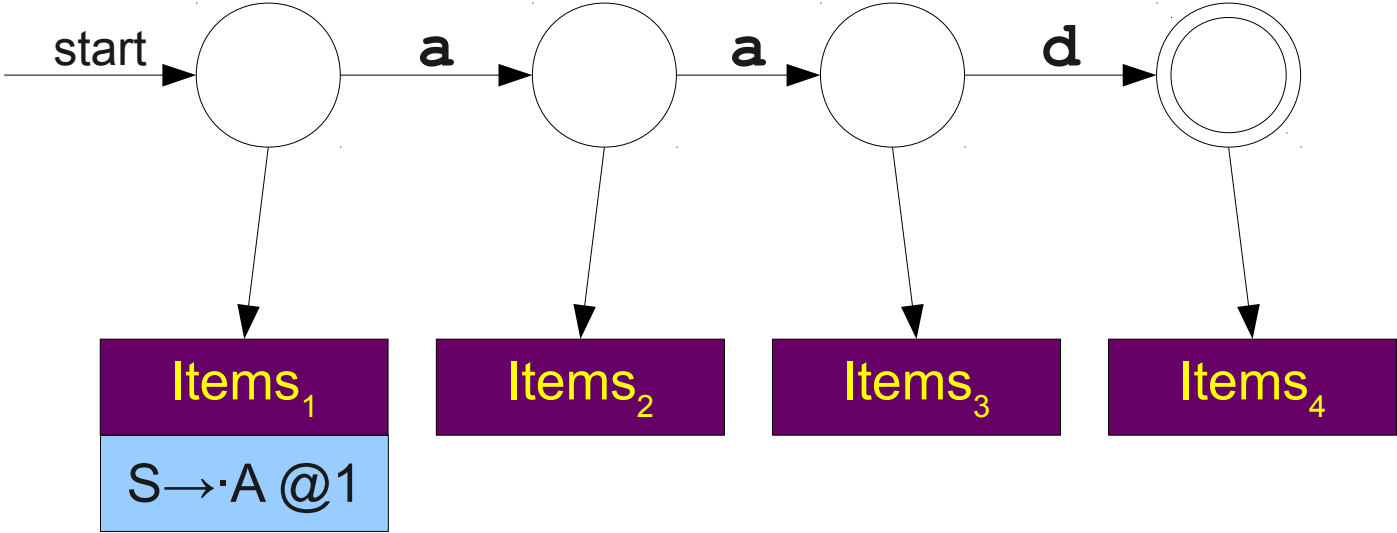

- $S \rightarrow A$
- $A \rightarrow Ba$
- $A \rightarrow Bb$
- $A \rightarrow Cab$
- $A \rightarrow Ad$
- $B \rightarrow a$
- $C \rightarrow a$

An Observation

SCAN
COMPLETE
PREDICT

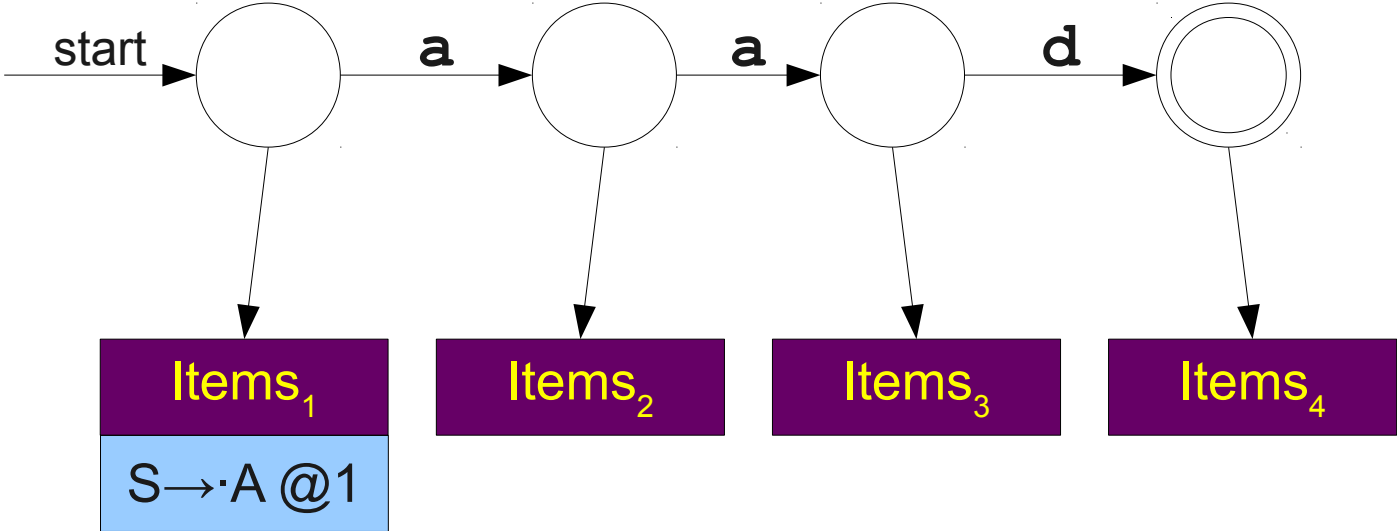

- $S \rightarrow A$
- $A \rightarrow Ba$
- $A \rightarrow Bb$
- $A \rightarrow Cab$
- $A \rightarrow Ad$
- $B \rightarrow a$
- $C \rightarrow a$

An Observation

SCAN
COMPLETE
PREDICT

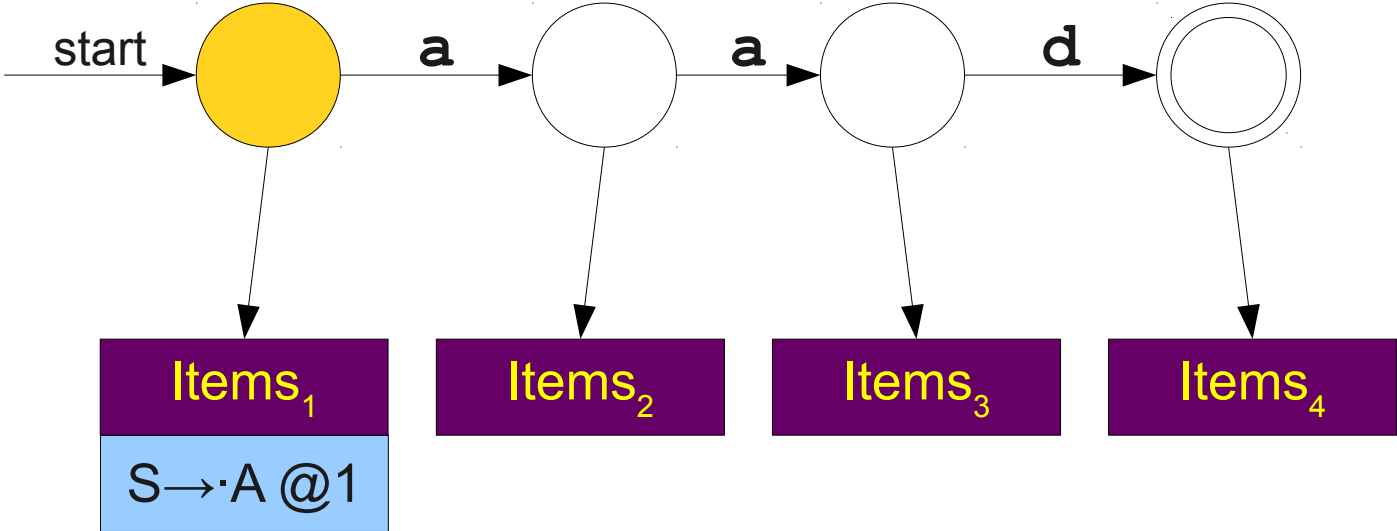

- $S \rightarrow A$
- $A \rightarrow Ba$
- $A \rightarrow Bb$
- $A \rightarrow Cab$
- $A \rightarrow Ad$
- $B \rightarrow a$
- $C \rightarrow a$

An Observation

||
||
||
||

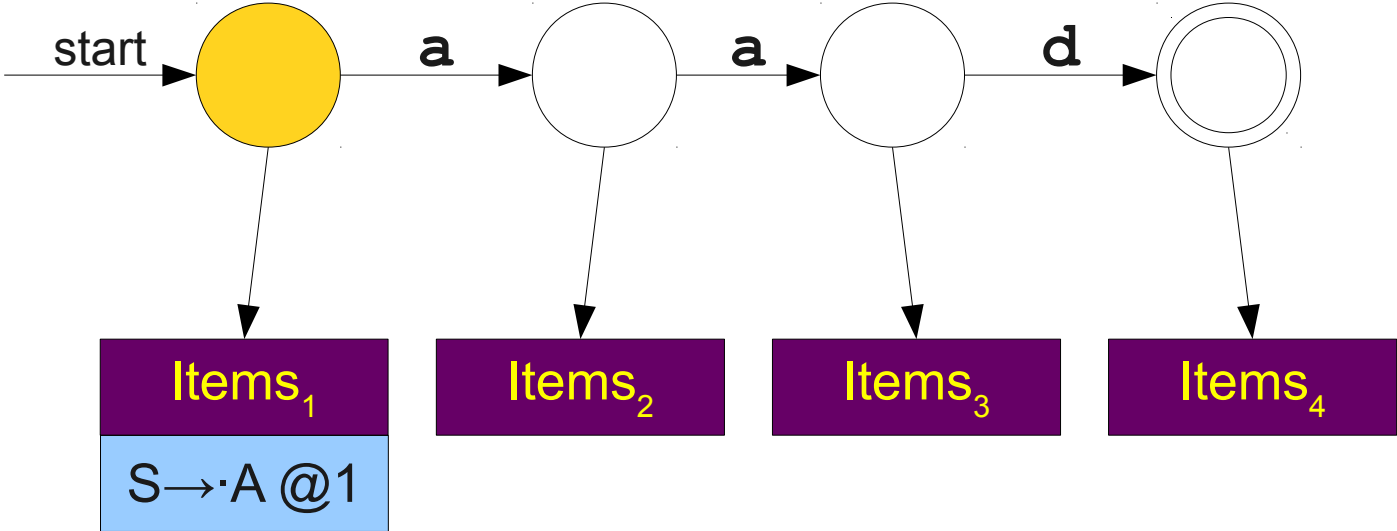

- $S \rightarrow A$
- $A \rightarrow Ba$
- $A \rightarrow Bb$
- $A \rightarrow Cab$
- $A \rightarrow Ad$
- $B \rightarrow a$
- $C \rightarrow a$

An Observation

SCAN
COMPLETE
PREDICT

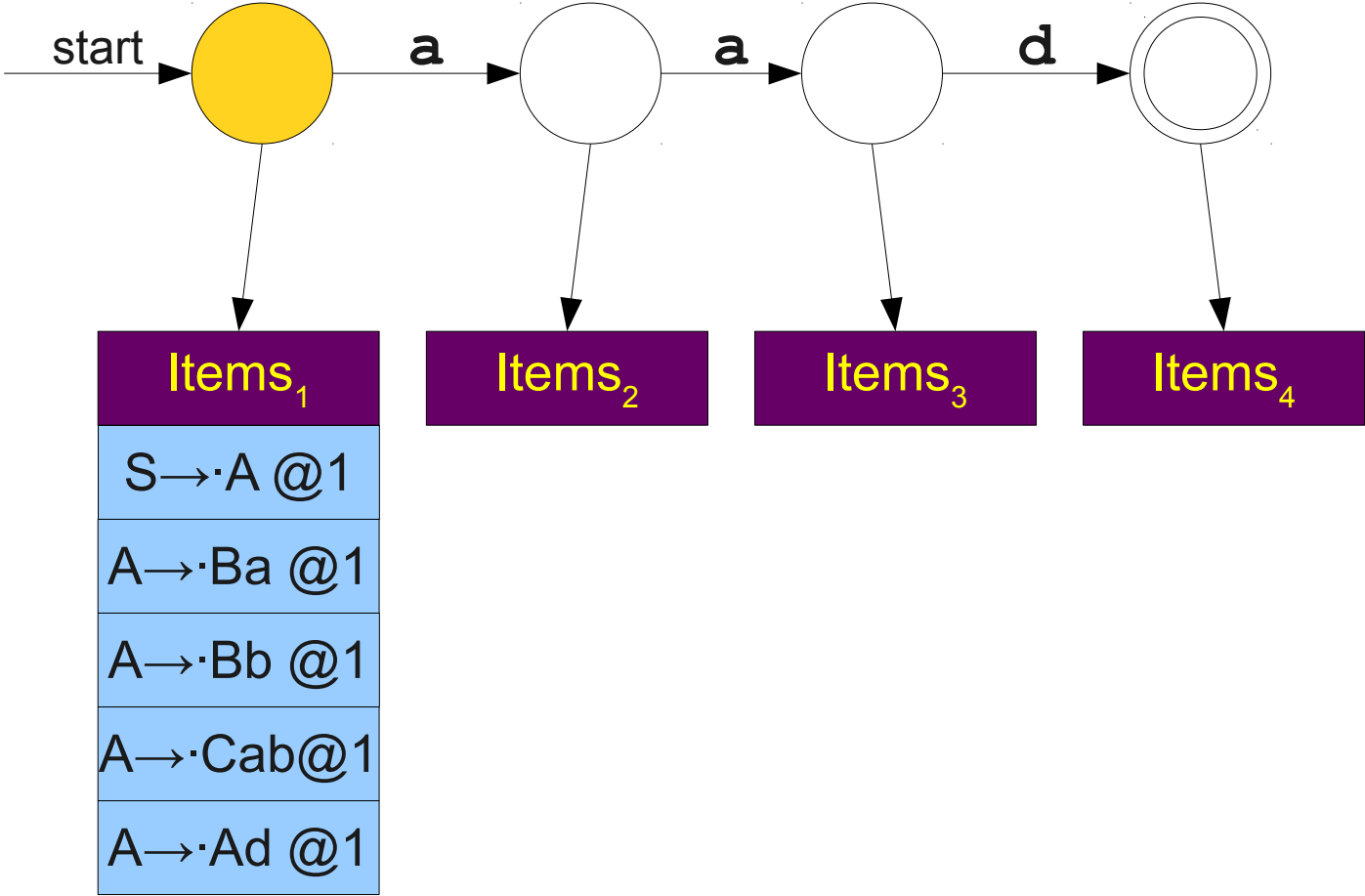

- $S \rightarrow A$
- $A \rightarrow Ba$
- $A \rightarrow Bb$
- $A \rightarrow Cab$
- $A \rightarrow Ad$
- $B \rightarrow a$
- $C \rightarrow a$

An Observation

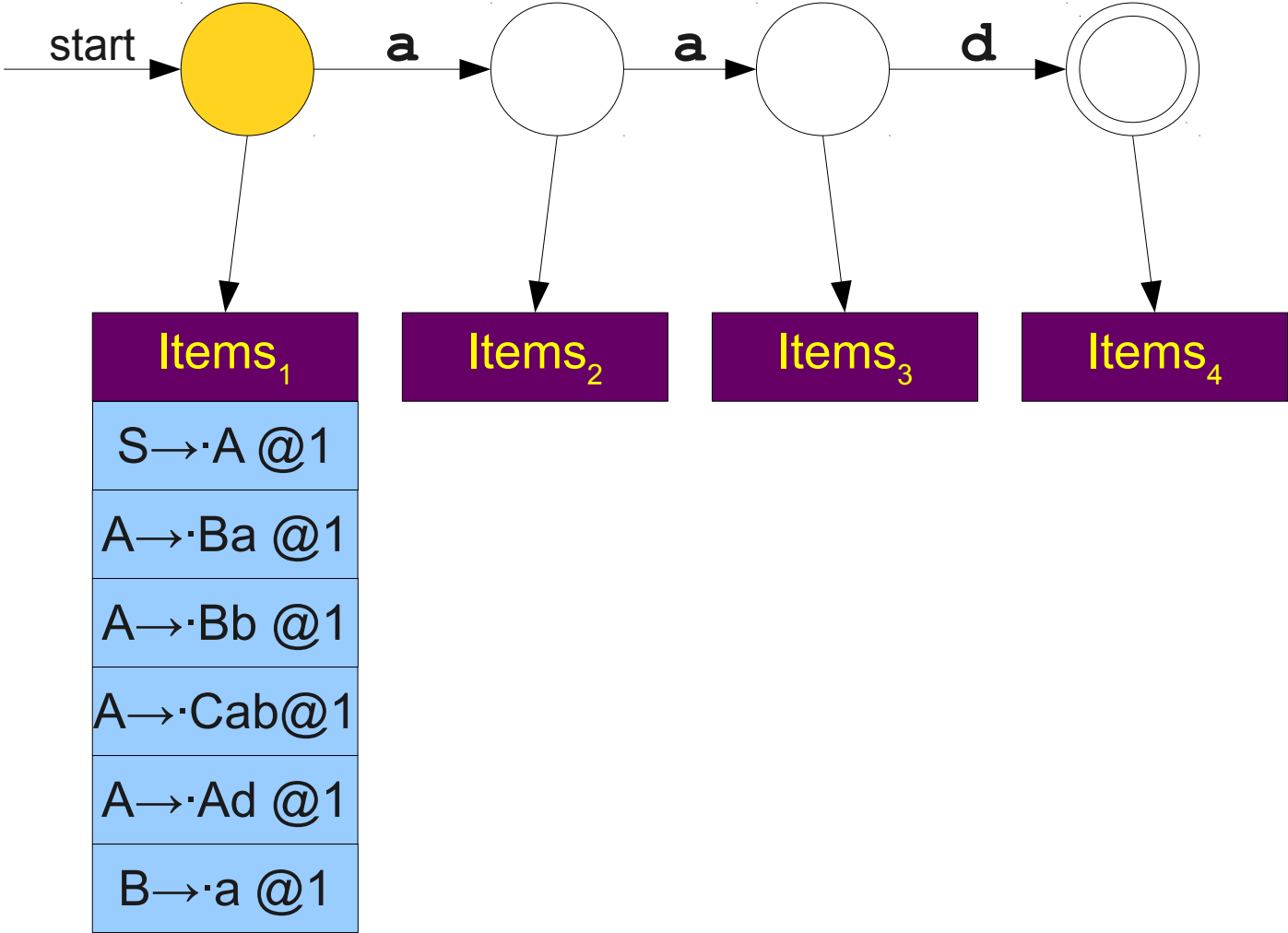
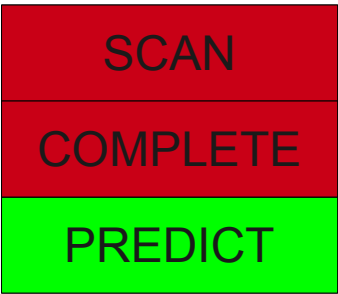

- $S \rightarrow A$
- $A \rightarrow Ba$
- $A \rightarrow Bb$
- $A \rightarrow Cab$
- $A \rightarrow Ad$
- $B \rightarrow a$
- $C \rightarrow a$

An Observation

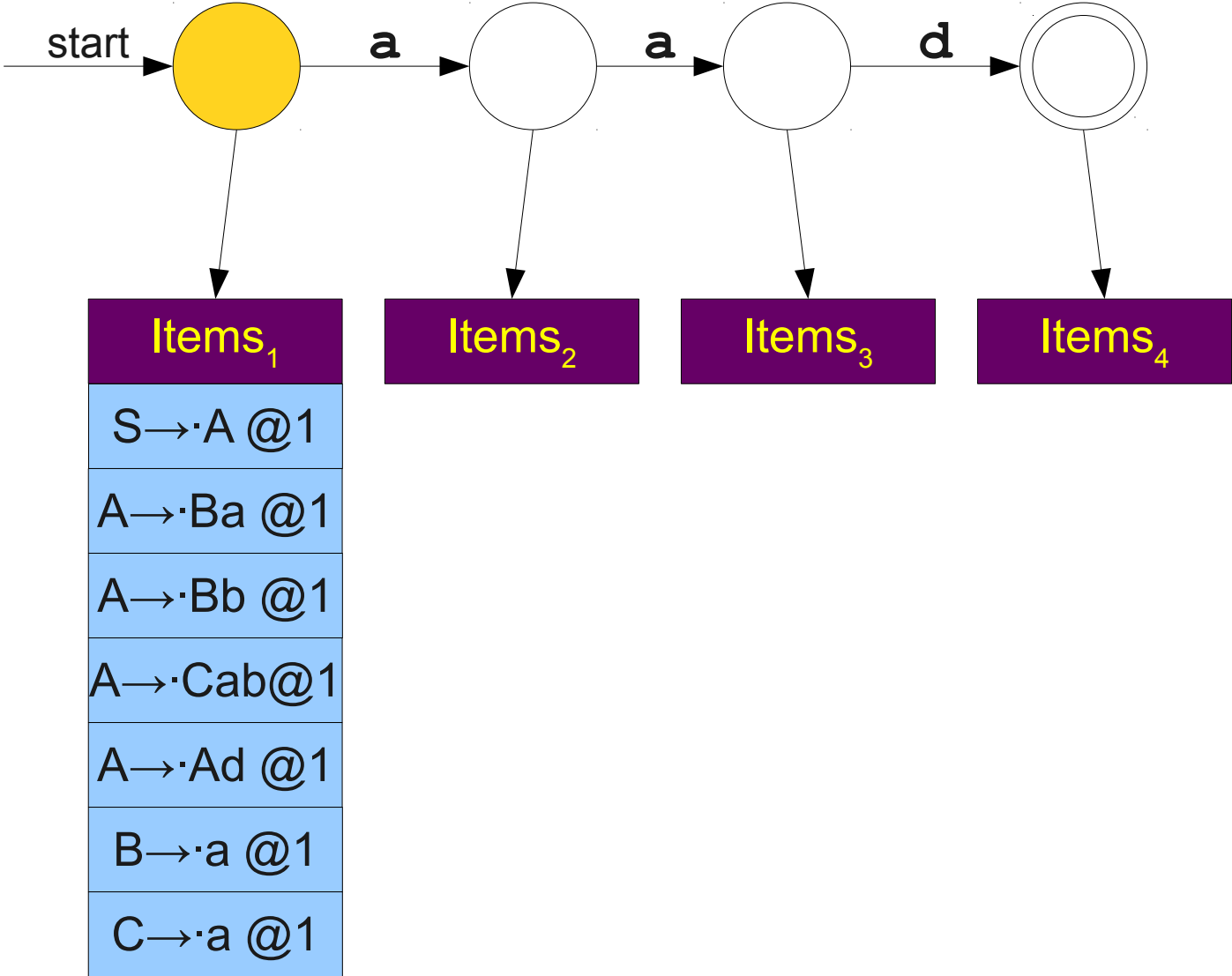
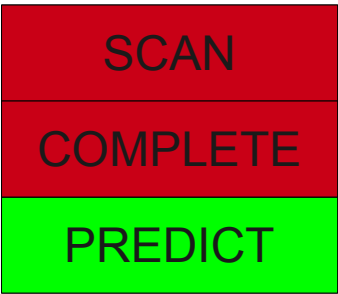

- $S \rightarrow A$
- $A \rightarrow Ba$
- $A \rightarrow Bb$
- $A \rightarrow Cab$
- $A \rightarrow Ad$
- $B \rightarrow a$
- $C \rightarrow a$

An Observation

SCAN
COMPLETE
PREDICT

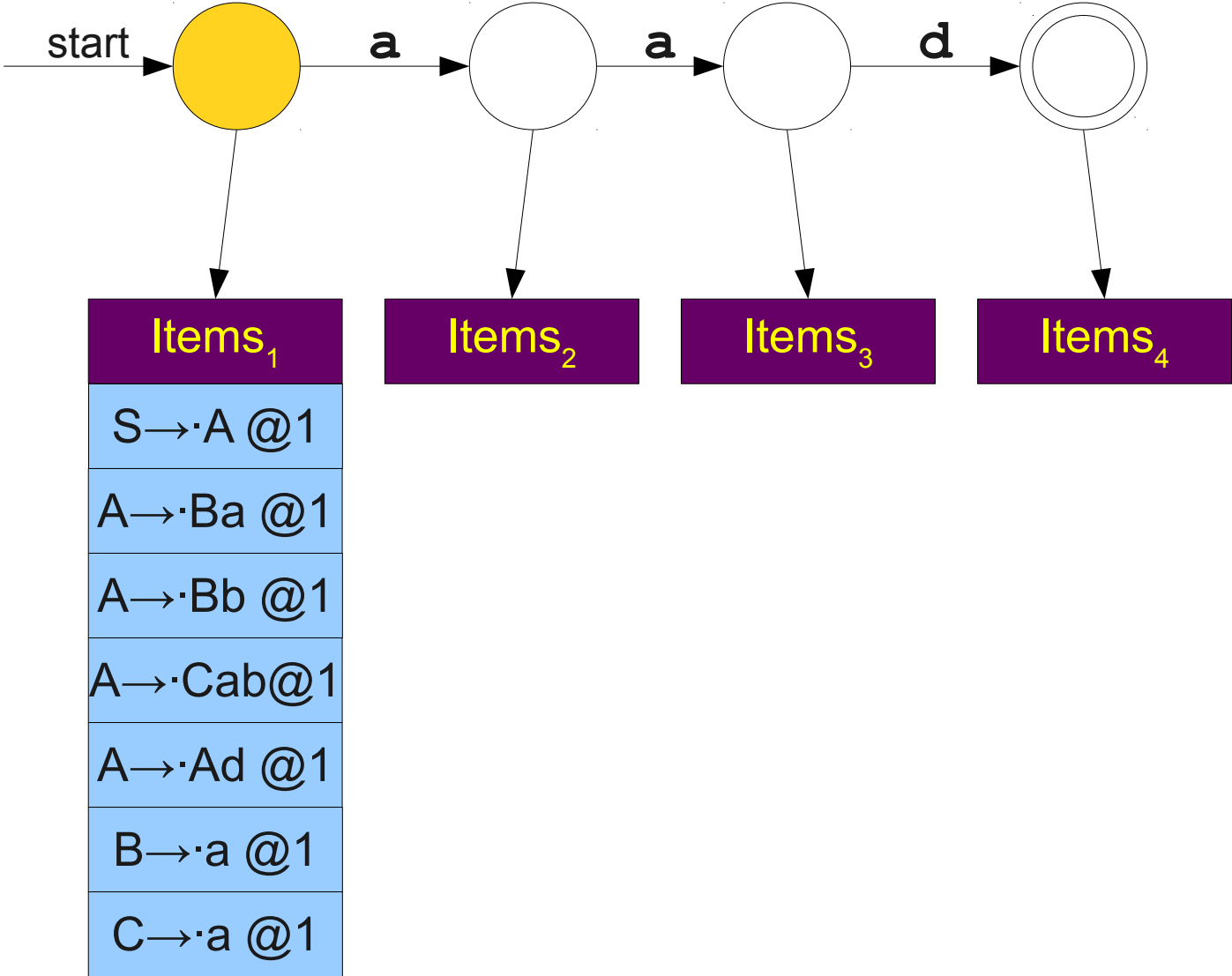

- $S \rightarrow A$
- $A \rightarrow Ba$
- $A \rightarrow Bb$
- $A \rightarrow Cab$
- $A \rightarrow Ad$
- $B \rightarrow a$
- $C \rightarrow a$

An Observation

SCAN
COMPLETE
PREDICT

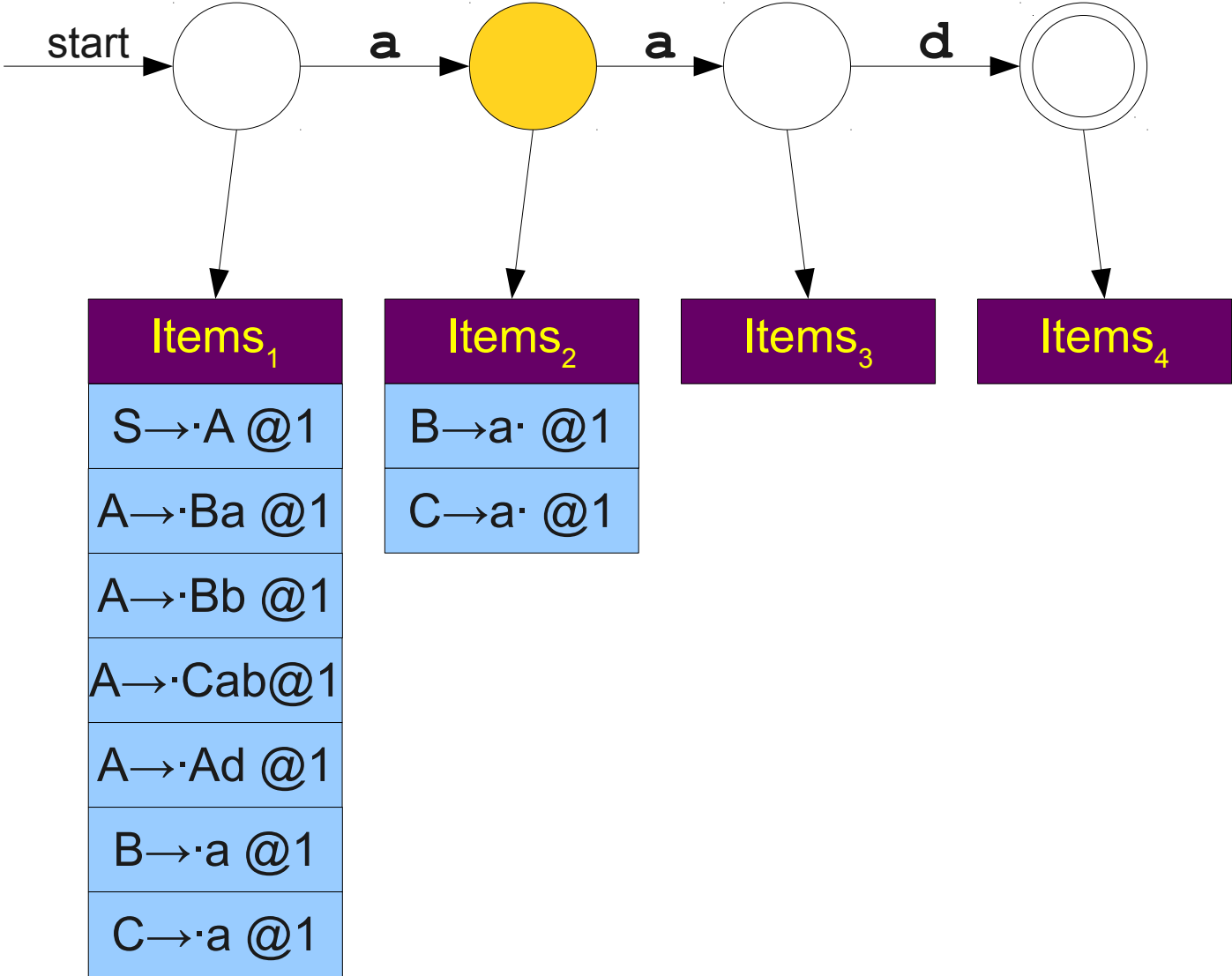

- $S \rightarrow A$
- $A \rightarrow Ba$
- $A \rightarrow Bb$
- $A \rightarrow Cab$
- $A \rightarrow Ad$
- $B \rightarrow a$
- $C \rightarrow a$

An Observation

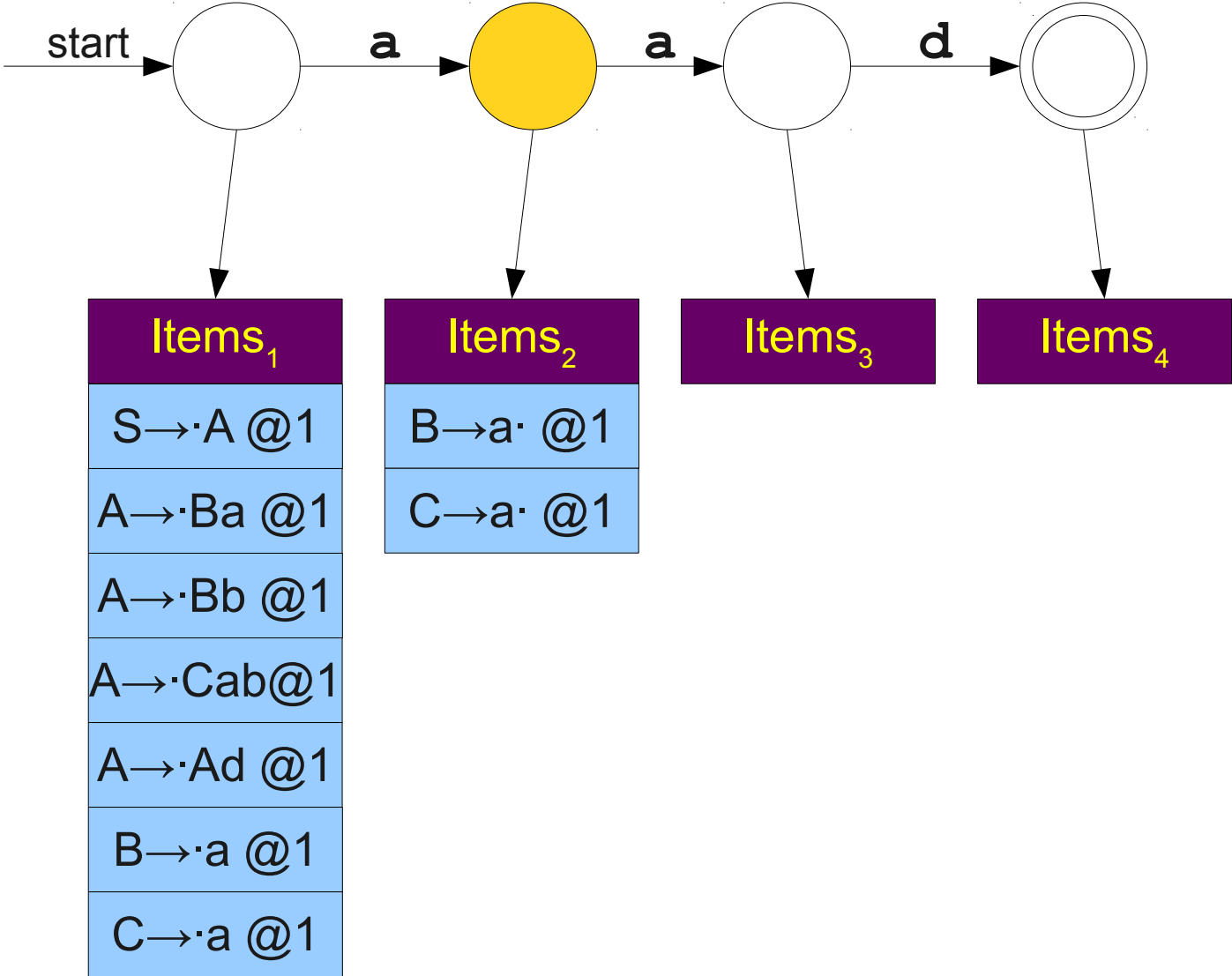
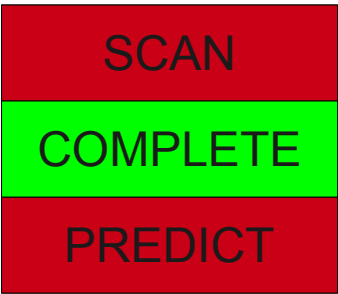

$S \rightarrow A$
 $A \rightarrow Ba$
 $A \rightarrow Bb$
 $A \rightarrow Cab$
 $A \rightarrow Ad$
 $B \rightarrow a$
 $C \rightarrow a$

An Observation

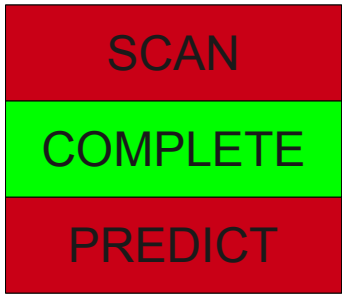

$B_{1-2} \rightarrow a_{1-2}$
 $C_{1-2} \rightarrow a_{1-2}$

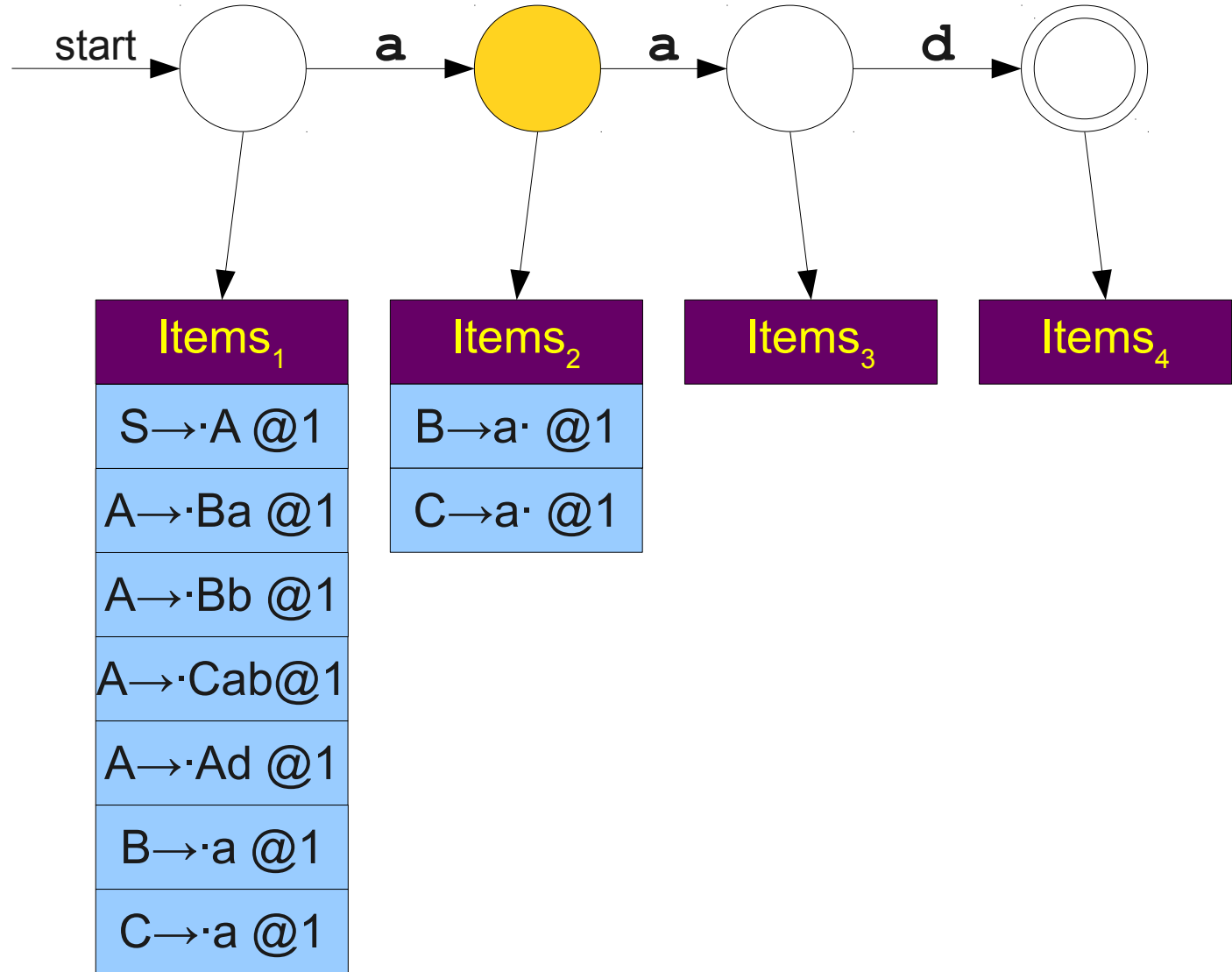

$S \rightarrow A$
 $A \rightarrow Ba$
 $A \rightarrow Bb$
 $A \rightarrow Cab$
 $A \rightarrow Ad$
 $B \rightarrow a$
 $C \rightarrow a$

An Observation

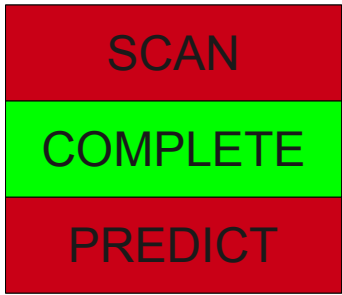

$B_{1-2} \rightarrow a_{1-2}$
 $C_{1-2} \rightarrow a_{1-2}$

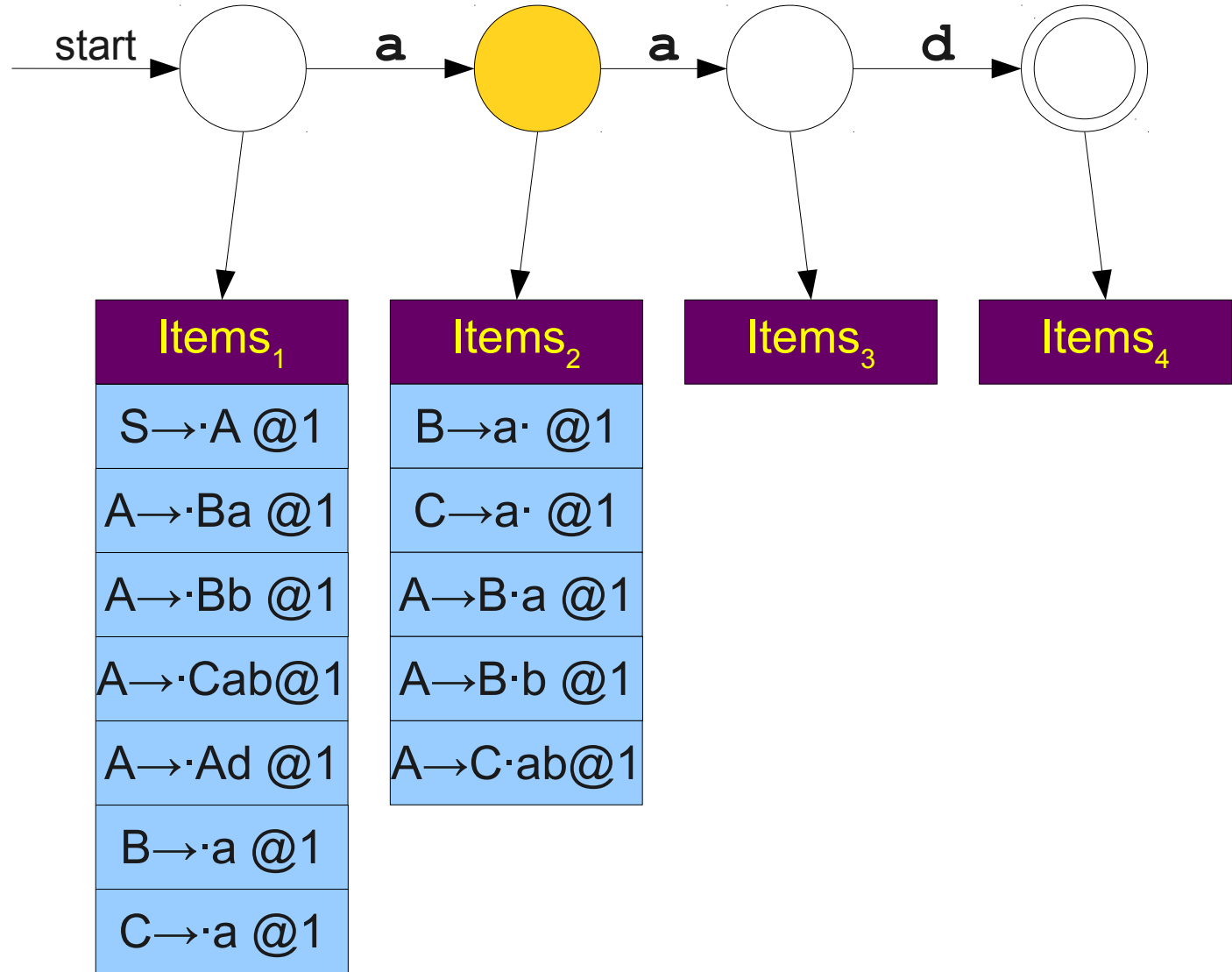

$S \rightarrow A$
 $A \rightarrow Ba$
 $A \rightarrow Bb$
 $A \rightarrow Cab$
 $A \rightarrow Ad$
 $B \rightarrow a$
 $C \rightarrow a$

An Observation

SCAN
COMPLETE
PREDICT

$B_{1-2} \rightarrow a_{1-2}$
 $C_{1-2} \rightarrow a_{1-2}$

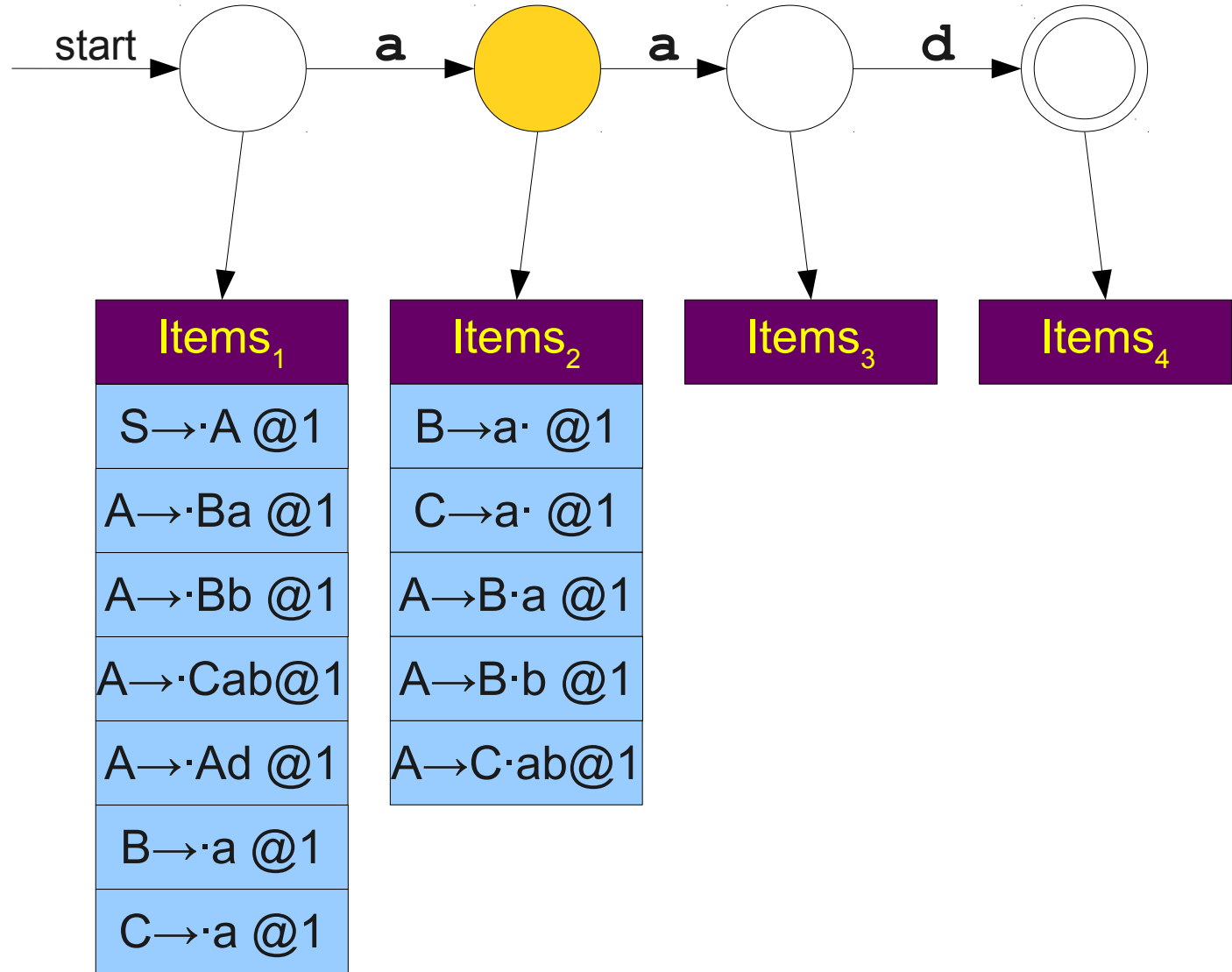

$S \rightarrow A$
 $A \rightarrow Ba$
 $A \rightarrow Bb$
 $A \rightarrow Cab$
 $A \rightarrow Ad$
 $B \rightarrow a$
 $C \rightarrow a$

An Observation

SCAN
COMPLETE
PREDICT

$B_{1-2} \rightarrow a_{1-2}$
 $C_{1-2} \rightarrow a_{1-2}$

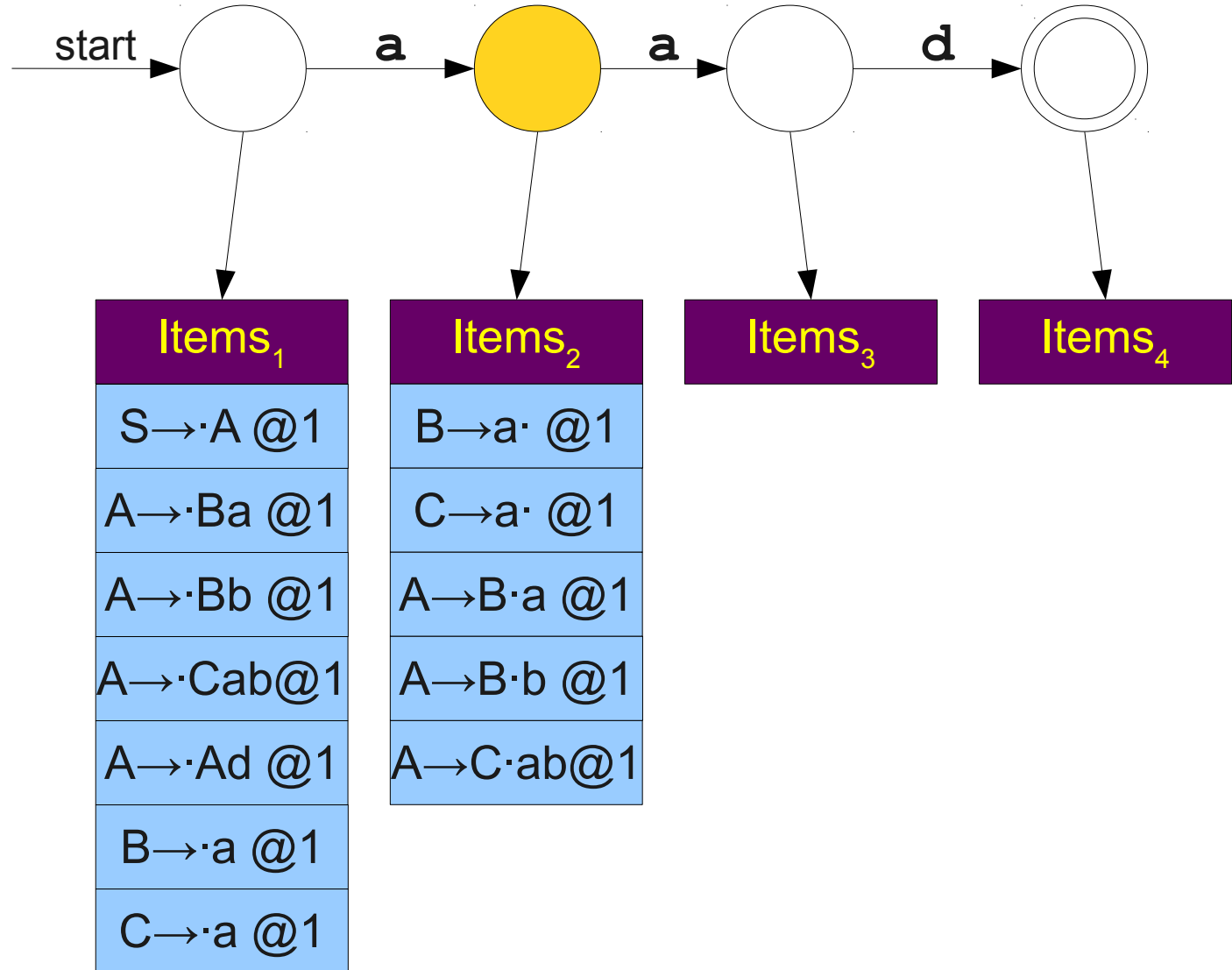

$S \rightarrow A$
 $A \rightarrow Ba$
 $A \rightarrow Bb$
 $A \rightarrow Cab$
 $A \rightarrow Ad$
 $B \rightarrow a$
 $C \rightarrow a$

An Observation

SCAN
 COMPLETE
 PREDICT

$B_{1-2} \rightarrow a_{1-2}$
 $C_{1-2} \rightarrow a_{1-2}$

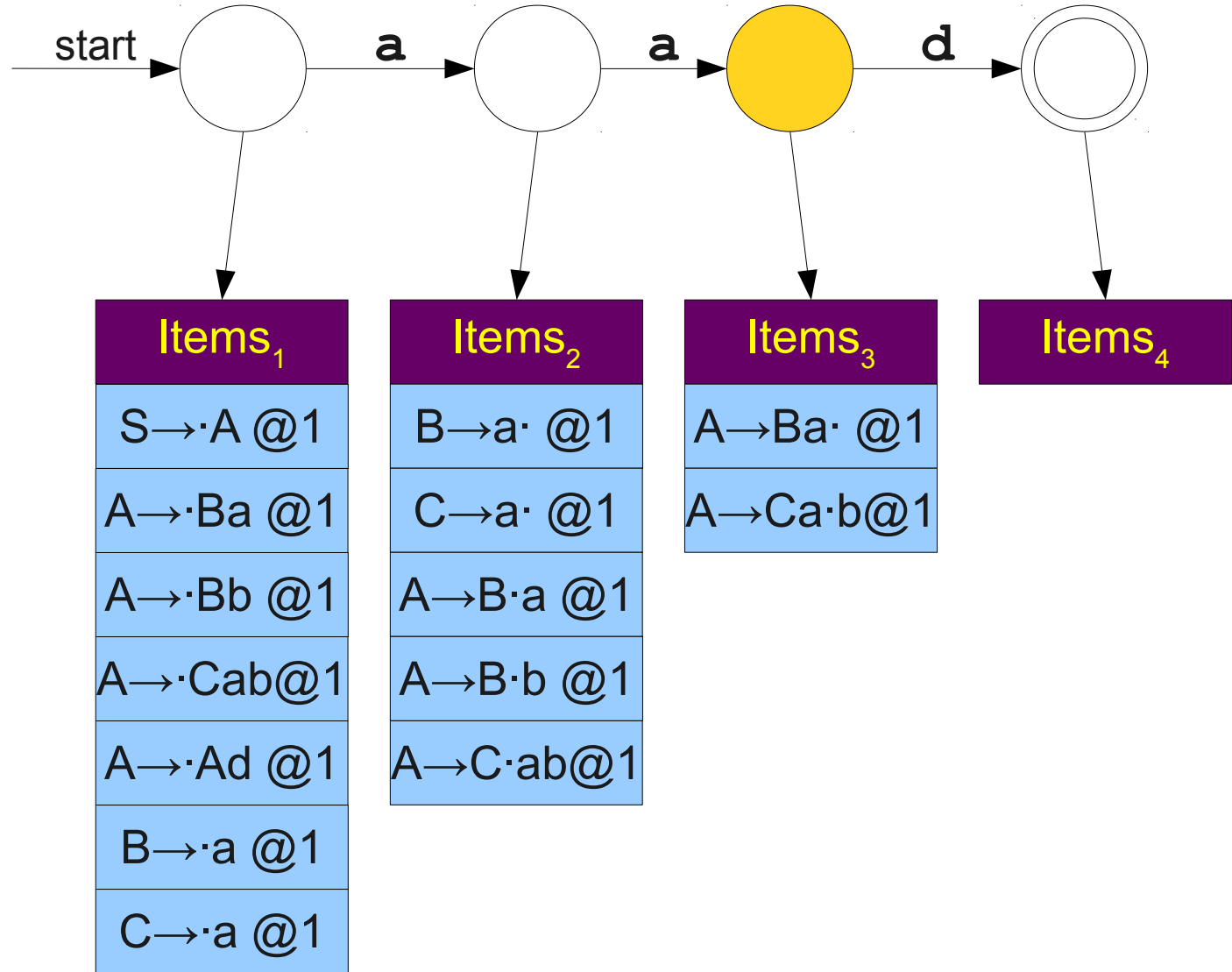

$S \rightarrow A$
 $A \rightarrow Ba$
 $A \rightarrow Bb$
 $A \rightarrow Cab$
 $A \rightarrow Ad$
 $B \rightarrow a$
 $C \rightarrow a$

An Observation

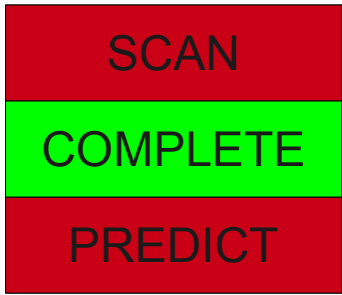

$B_{1-2} \rightarrow a_{1-2}$
 $C_{1-2} \rightarrow a_{1-2}$

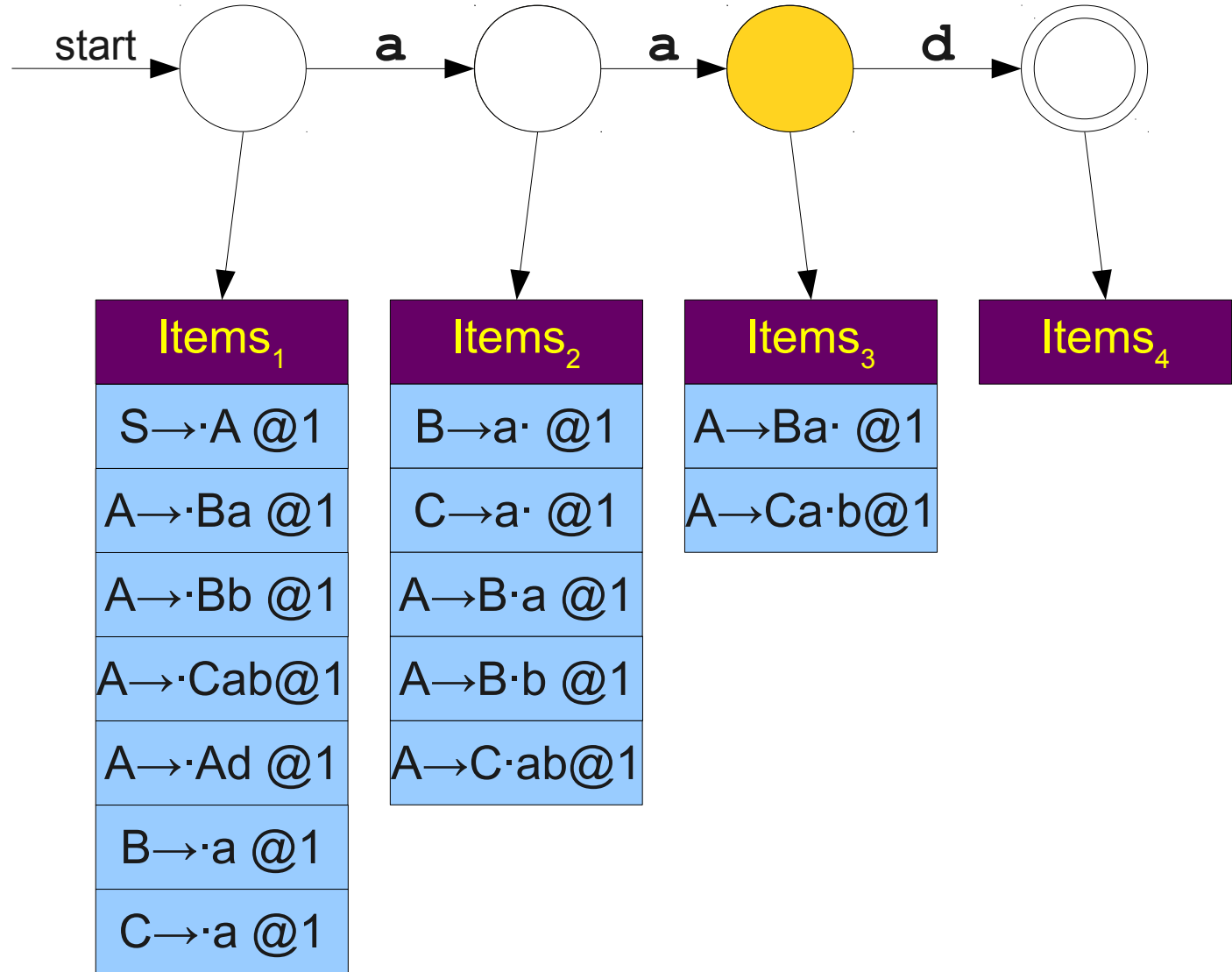

$S \rightarrow A$
 $A \rightarrow Ba$
 $A \rightarrow Bb$
 $A \rightarrow Cab$
 $A \rightarrow Ad$
 $B \rightarrow a$
 $C \rightarrow a$

An Observation

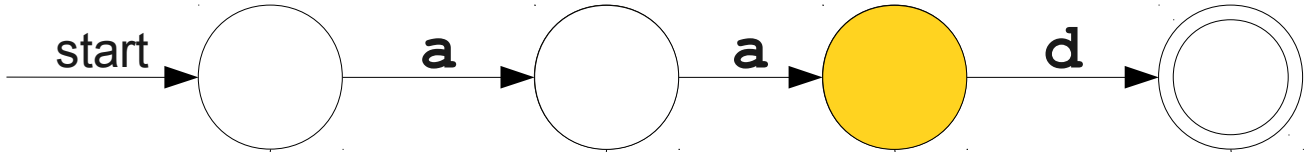
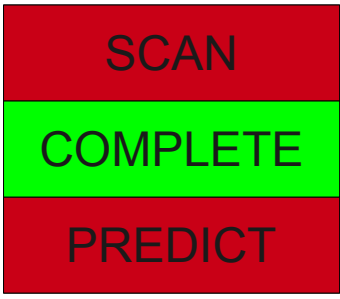

$B_{1-2} \rightarrow a_{1-2}$
 $C_{1-2} \rightarrow a_{1-2}$
 $A_{1-3} \rightarrow B_{1-2} a_{2-3}$

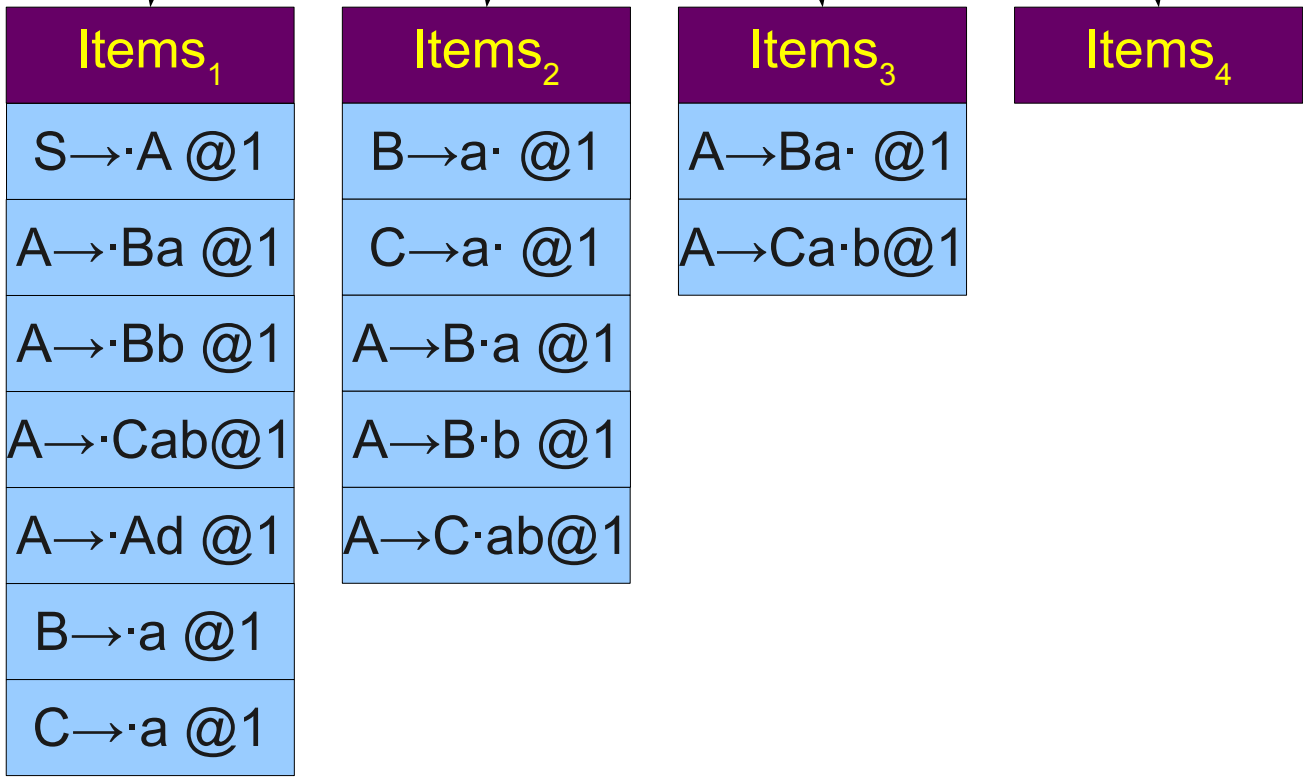

$S \rightarrow A$
 $A \rightarrow Ba$
 $A \rightarrow Bb$
 $A \rightarrow Cab$
 $A \rightarrow Ad$
 $B \rightarrow a$
 $C \rightarrow a$

An Observation

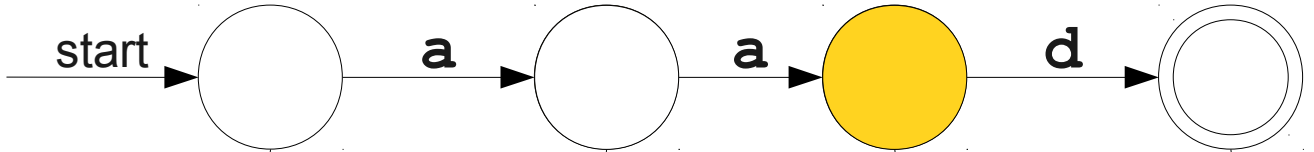
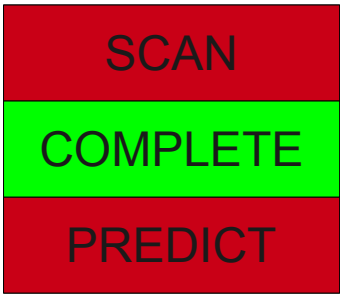

$B_{1-2} \rightarrow a_{1-2}$
 $C_{1-2} \rightarrow a_{1-2}$
 $A_{1-3} \rightarrow B_{1-2} a_{2-3}$

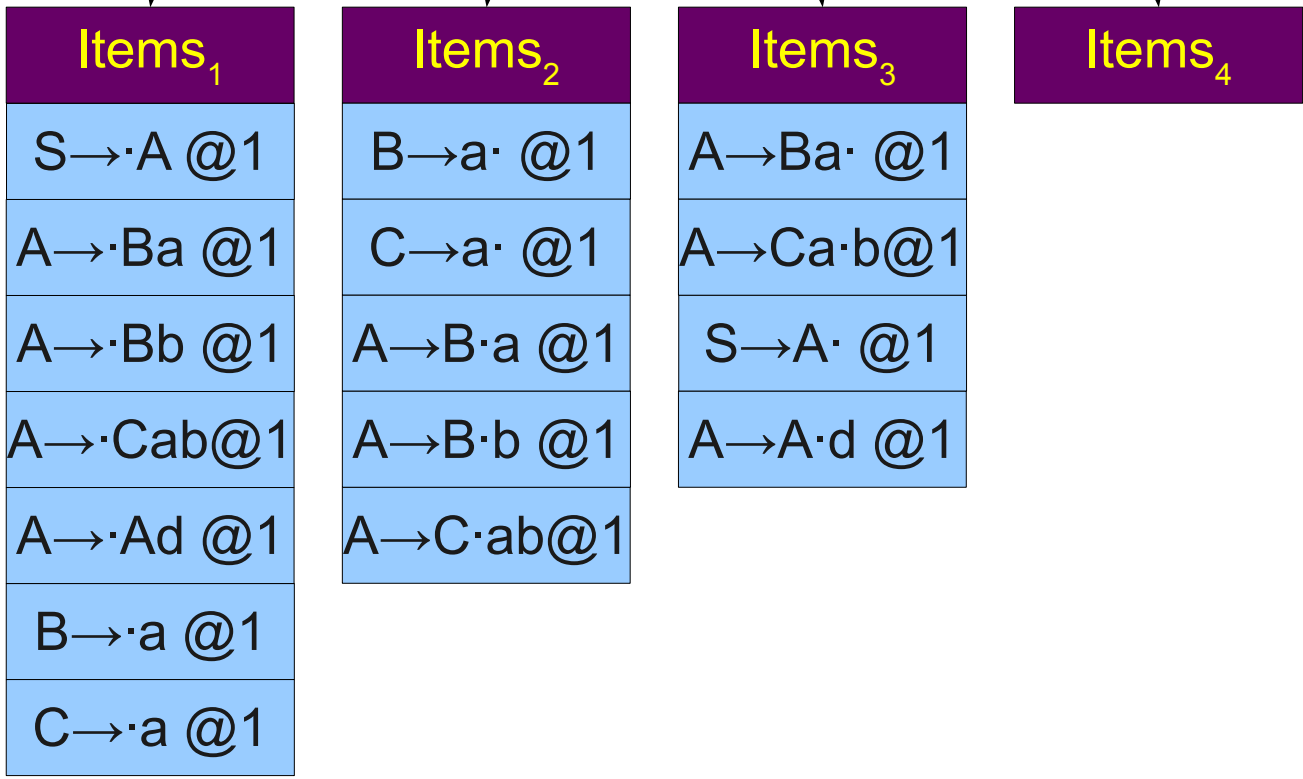

$S \rightarrow A$
 $A \rightarrow Ba$
 $A \rightarrow Bb$
 $A \rightarrow Cab$
 $A \rightarrow Ad$
 $B \rightarrow a$
 $C \rightarrow a$

An Observation

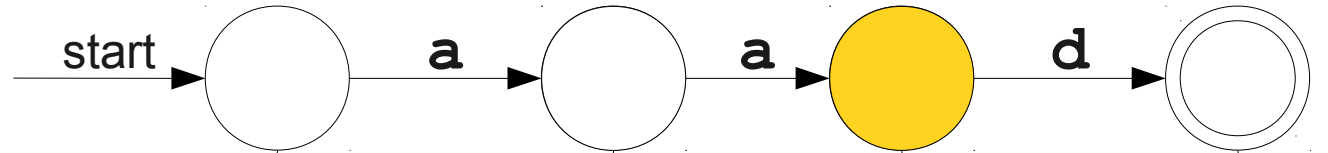
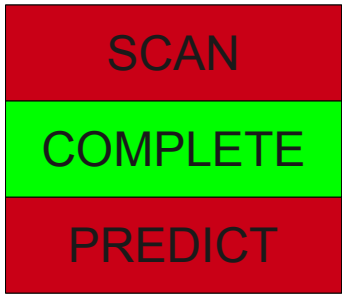

$B_{1-2} \rightarrow a_{1-2}$
 $C_{1-2} \rightarrow a_{1-2}$
 $A_{1-3} \rightarrow B_{1-2} a_{2-3}$
 $S_{1-3} \rightarrow A_{1-3}$

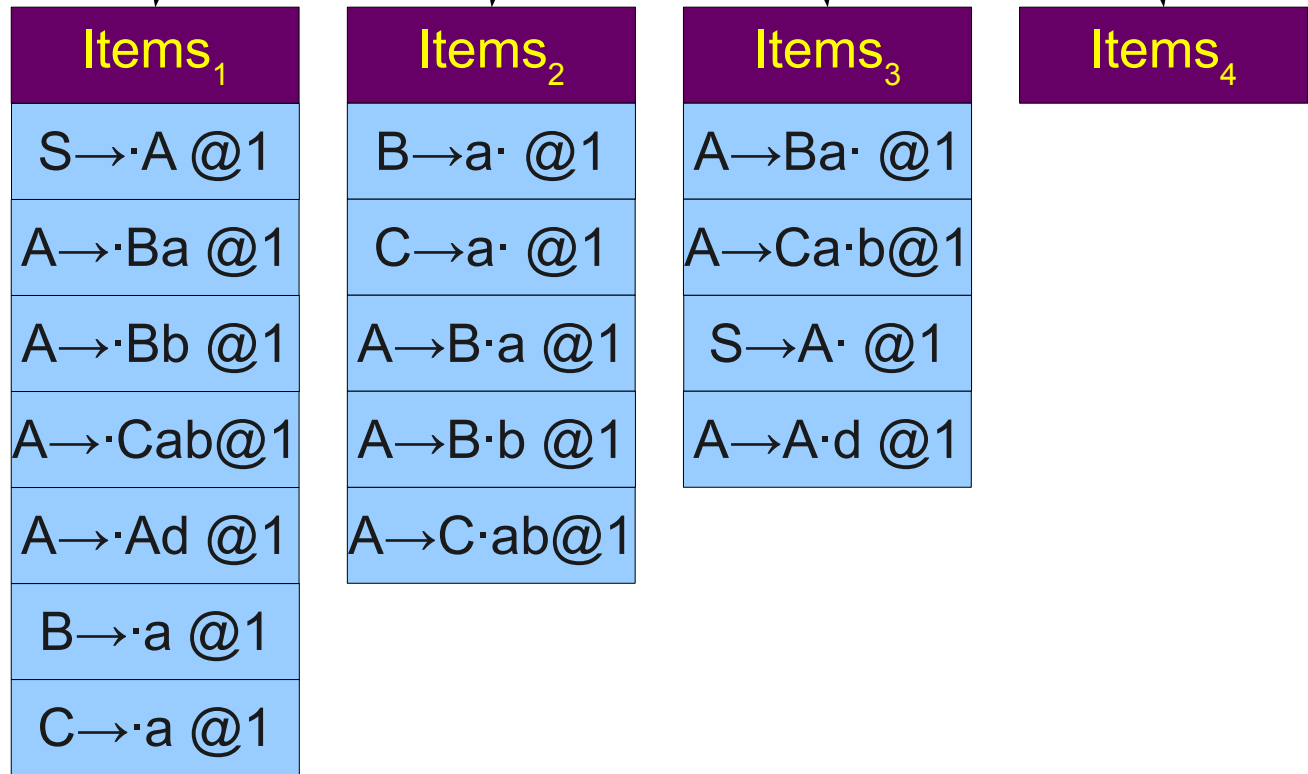

$S \rightarrow A$
 $A \rightarrow Ba$
 $A \rightarrow Bb$
 $A \rightarrow Cab$
 $A \rightarrow Ad$
 $B \rightarrow a$
 $C \rightarrow a$

An Observation

SCAN
 COMPLETE
 PREDICT

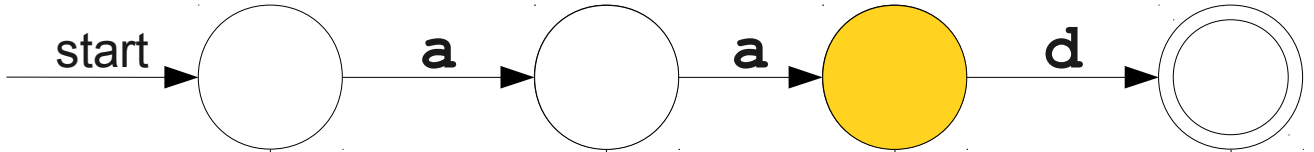

$B_{1-2} \rightarrow a_{1-2}$
 $C_{1-2} \rightarrow a_{1-2}$
 $A_{1-3} \rightarrow B_{1-2} a_{2-3}$
 $S_{1-3} \rightarrow A_{1-3}$

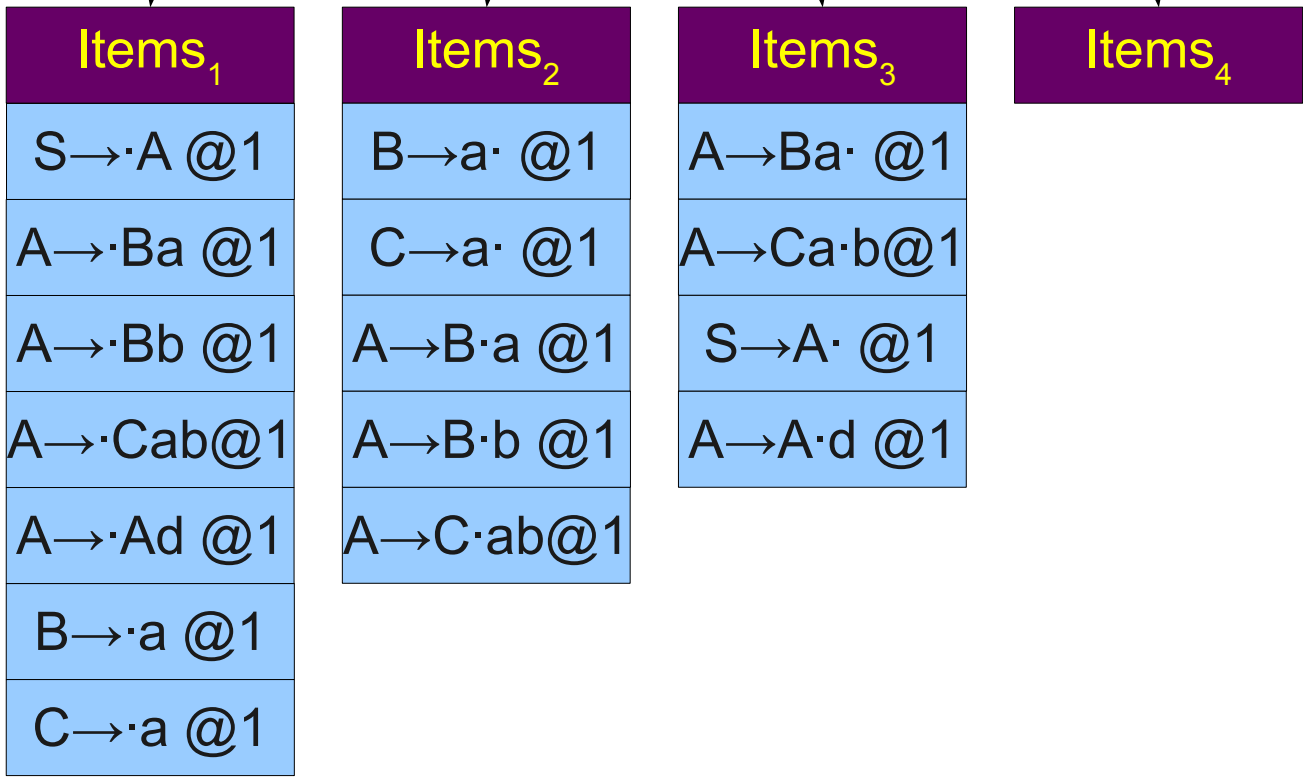

$S \rightarrow A$
 $A \rightarrow Ba$
 $A \rightarrow Bb$
 $A \rightarrow Cab$
 $A \rightarrow Ad$
 $B \rightarrow a$
 $C \rightarrow a$

An Observation

SCAN
COMPLETE
PREDICT

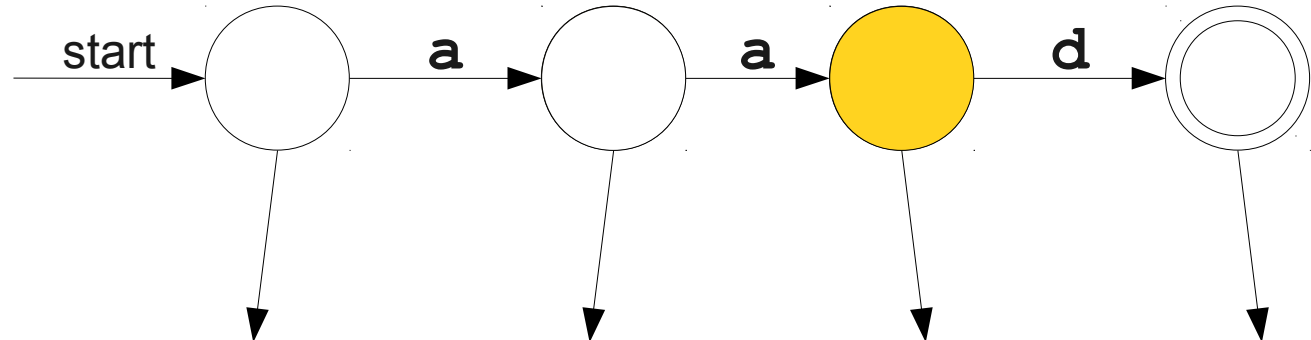

$B_{1-2} \rightarrow a_{1-2}$
 $C_{1-2} \rightarrow a_{1-2}$
 $A_{1-3} \rightarrow B_{1-2} a_{2-3}$
 $S_{1-3} \rightarrow A_{1-3}$

Items ₁	Items ₂	Items ₃	Items ₄
$S \rightarrow \cdot A @1$	$B \rightarrow a \cdot @1$	$A \rightarrow Ba \cdot @1$	
$A \rightarrow \cdot Ba @1$	$C \rightarrow a \cdot @1$	$A \rightarrow Ca \cdot b @1$	
$A \rightarrow \cdot Bb @1$	$A \rightarrow B \cdot a @1$	$S \rightarrow A \cdot @1$	
$A \rightarrow \cdot Cab @1$	$A \rightarrow B \cdot b @1$	$A \rightarrow A \cdot d @1$	
$A \rightarrow \cdot Ad @1$	$A \rightarrow C \cdot ab @1$		
$B \rightarrow \cdot a @1$			
$C \rightarrow \cdot a @1$			

$S \rightarrow A$
 $A \rightarrow Ba$
 $A \rightarrow Bb$
 $A \rightarrow Cab$
 $A \rightarrow Ad$
 $B \rightarrow a$
 $C \rightarrow a$

An Observation

SCAN
COMPLETE
PREDICT

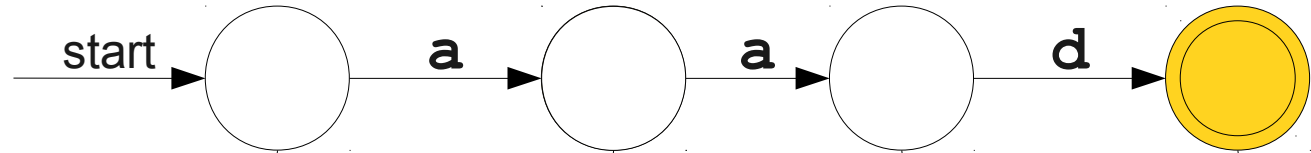

$B_{1-2} \rightarrow a_{1-2}$
 $C_{1-2} \rightarrow a_{1-2}$
 $A_{1-3} \rightarrow B_{1-2} a_{2-3}$
 $S_{1-3} \rightarrow A_{1-3}$

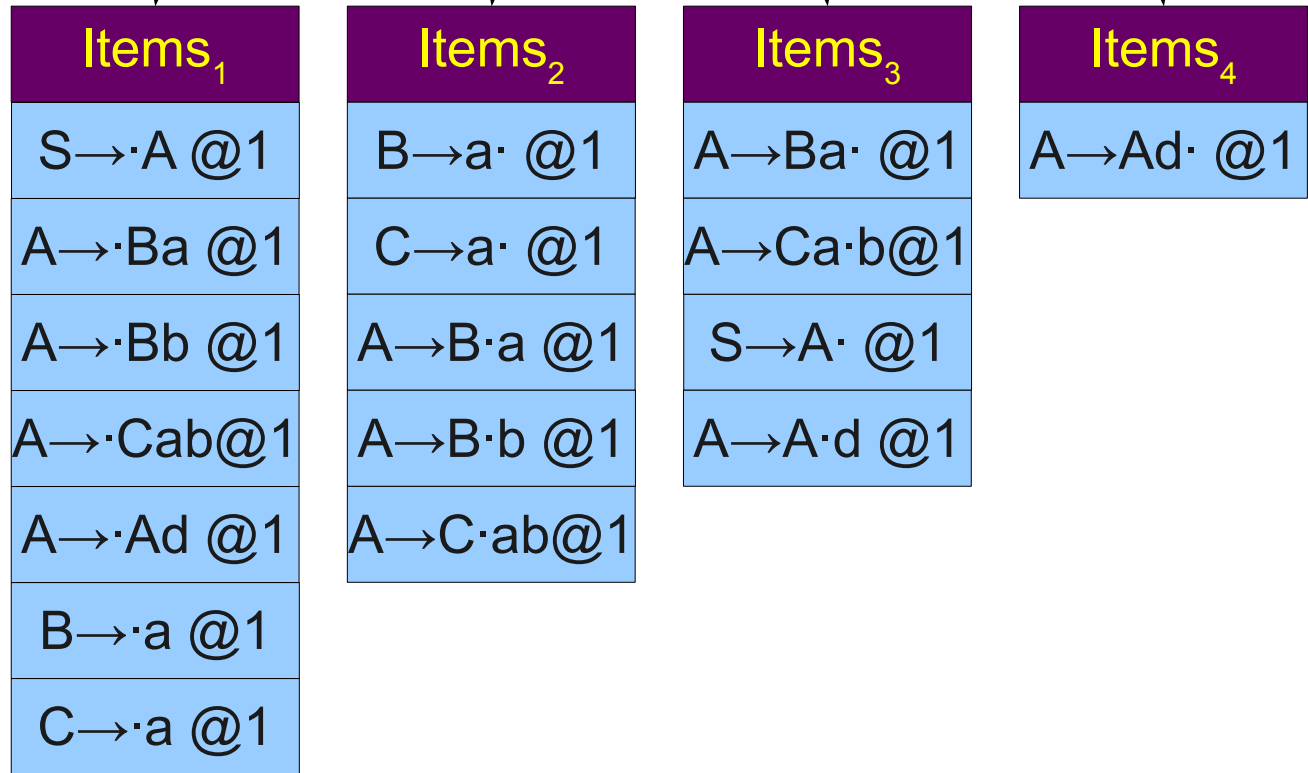

$S \rightarrow A$
 $A \rightarrow Ba$
 $A \rightarrow Bb$
 $A \rightarrow Cab$
 $A \rightarrow Ad$
 $B \rightarrow a$
 $C \rightarrow a$

An Observation

SCAN
 COMPLETE
 PREDICT

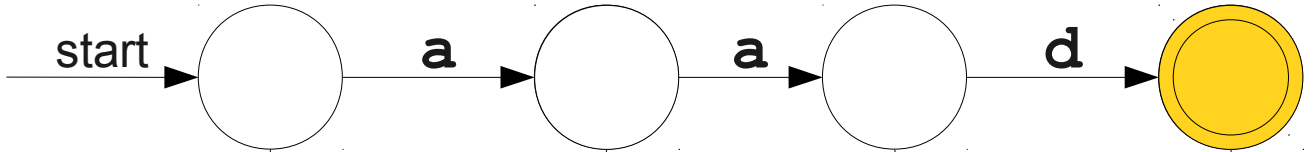

$B_{1-2} \rightarrow a_{1-2}$
 $C_{1-2} \rightarrow a_{1-2}$
 $A_{1-3} \rightarrow B_{1-2} a_{2-3}$
 $S_{1-3} \rightarrow A_{1-3}$

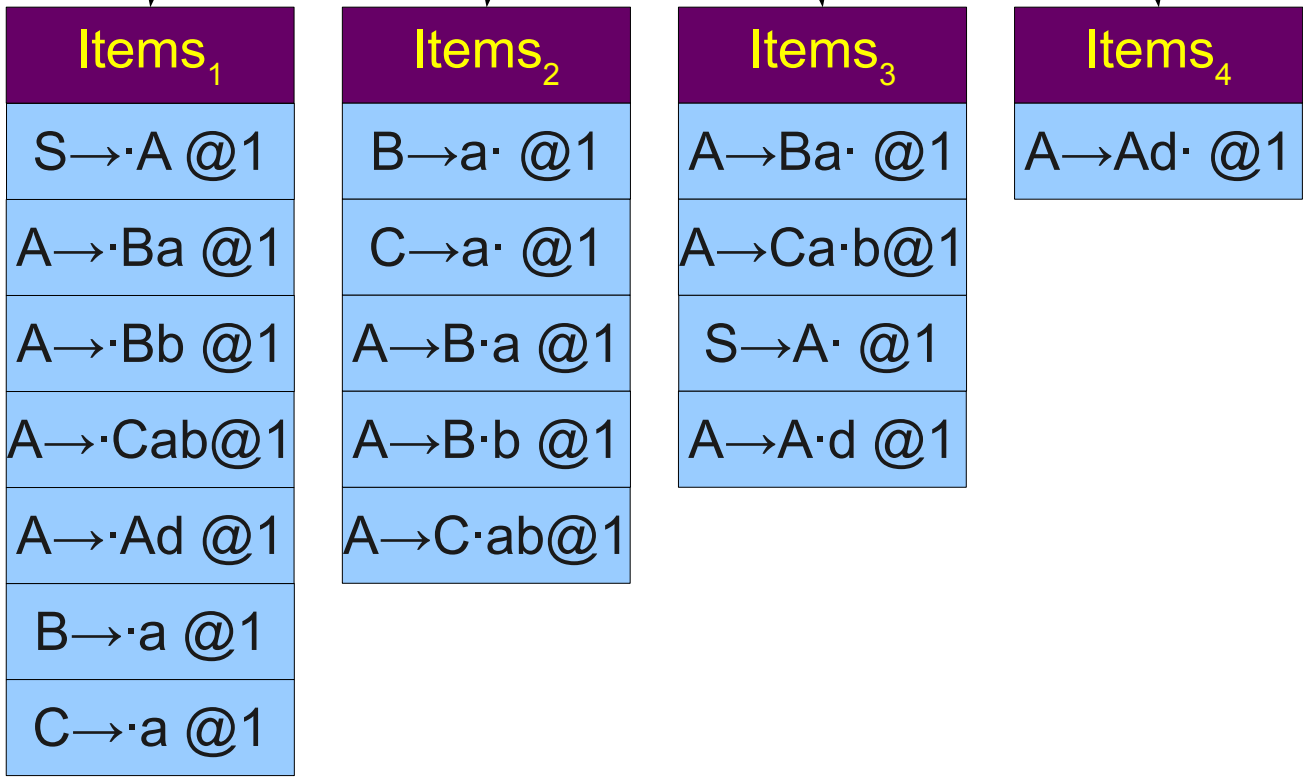

$S \rightarrow A$
 $A \rightarrow Ba$
 $A \rightarrow Bb$
 $A \rightarrow Cab$
 $A \rightarrow Ad$
 $B \rightarrow a$
 $C \rightarrow a$

An Observation

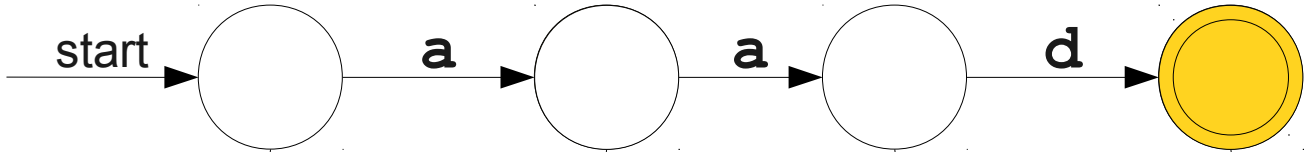
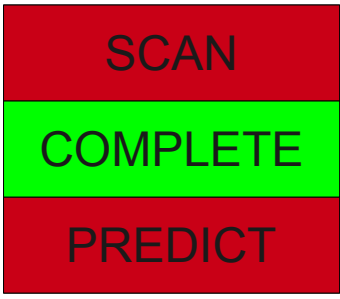

$B_{1-2} \rightarrow a_{1-2}$
 $C_{1-2} \rightarrow a_{1-2}$
 $A_{1-3} \rightarrow B_{1-2} a_{2-3}$
 $S_{1-3} \rightarrow A_{1-3}$
 $A_{1-4} \rightarrow A_{1-3} d_{3-4}$

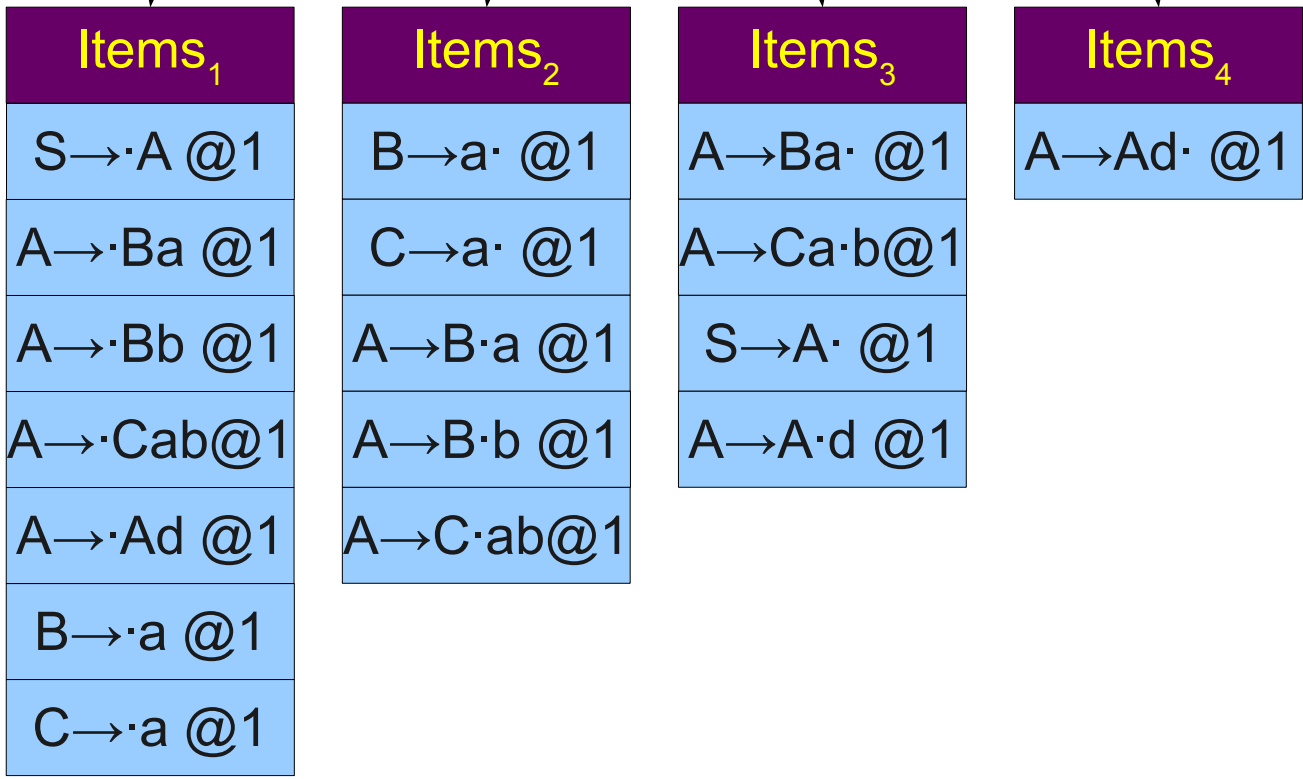

$S \rightarrow A$
 $A \rightarrow Ba$
 $A \rightarrow Bb$
 $A \rightarrow Cab$
 $A \rightarrow Ad$
 $B \rightarrow a$
 $C \rightarrow a$

An Observation

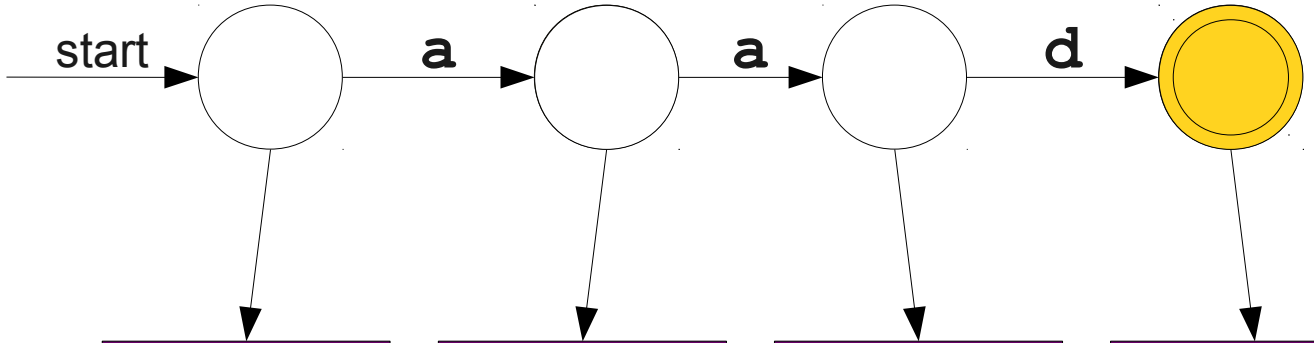
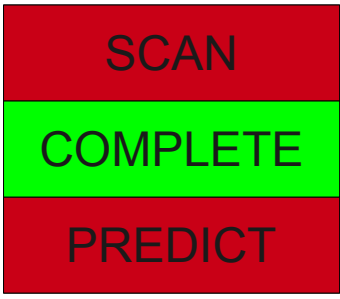

$B_{1-2} \rightarrow a_{1-2}$
 $C_{1-2} \rightarrow a_{1-2}$
 $A_{1-3} \rightarrow B_{1-2} a_{2-3}$
 $S_{1-3} \rightarrow A_{1-3}$
 $A_{1-4} \rightarrow A_{1-3} d_{3-4}$

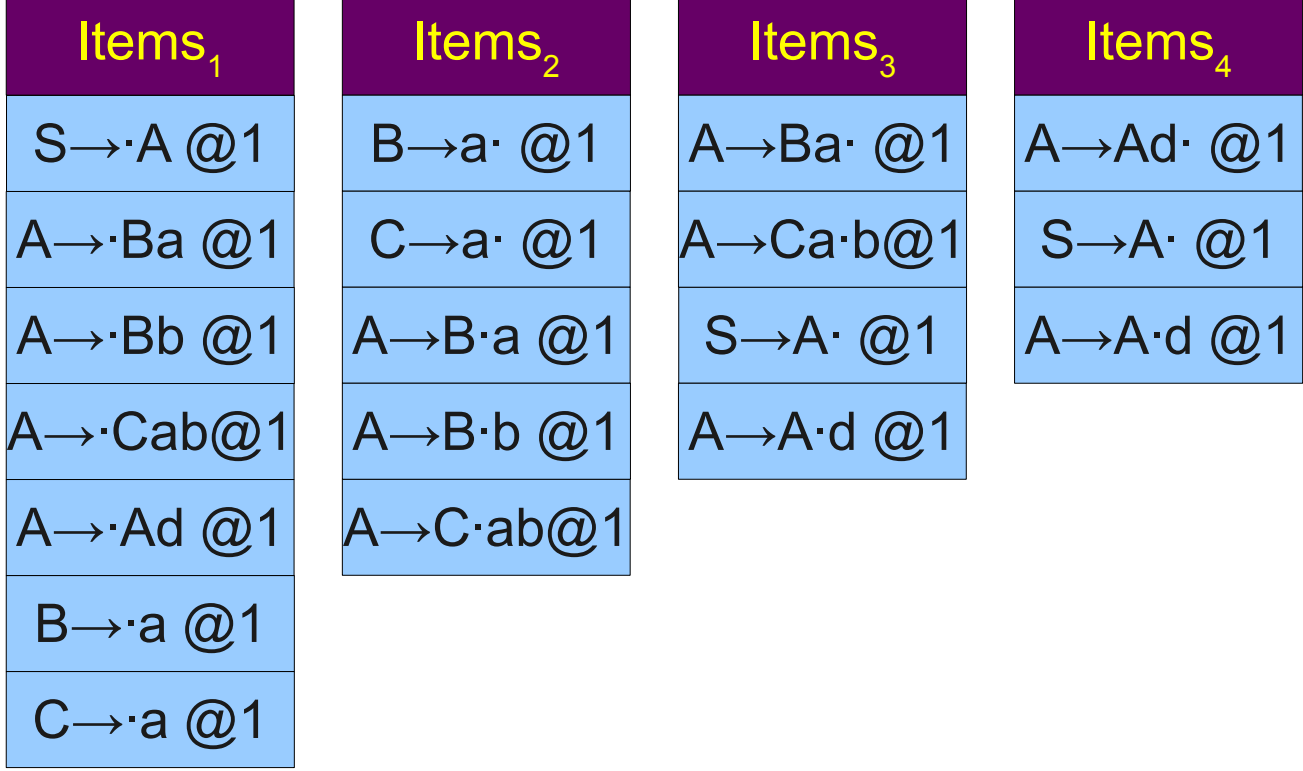

$S \rightarrow A$
 $A \rightarrow Ba$
 $A \rightarrow Bb$
 $A \rightarrow Cab$
 $A \rightarrow Ad$
 $B \rightarrow a$
 $C \rightarrow a$

An Observation

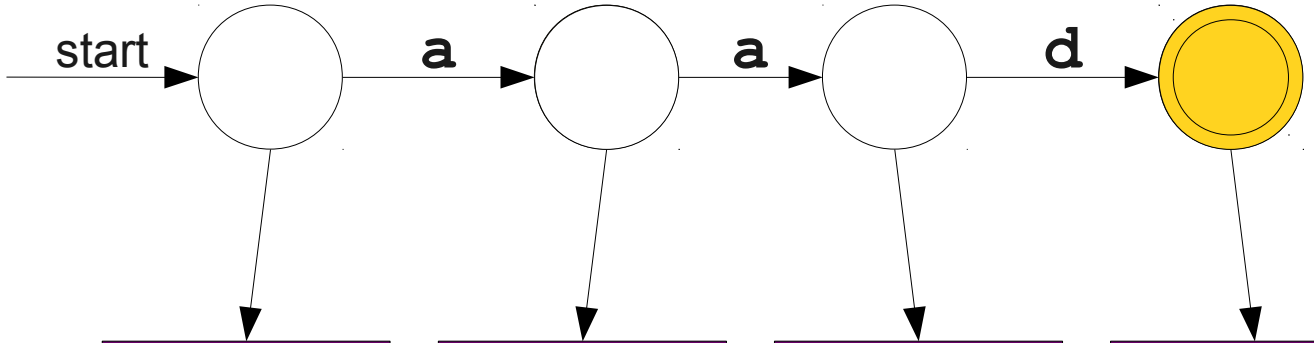
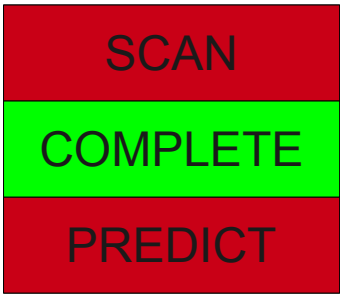

$B_{1-2} \rightarrow a_{1-2}$
 $C_{1-2} \rightarrow a_{1-2}$
 $A_{1-3} \rightarrow B_{1-2} a_{2-3}$
 $S_{1-3} \rightarrow A_{1-3}$
 $A_{1-4} \rightarrow A_{1-3} d_{3-4}$
 $S_{1-4} \rightarrow A_{1-4}$

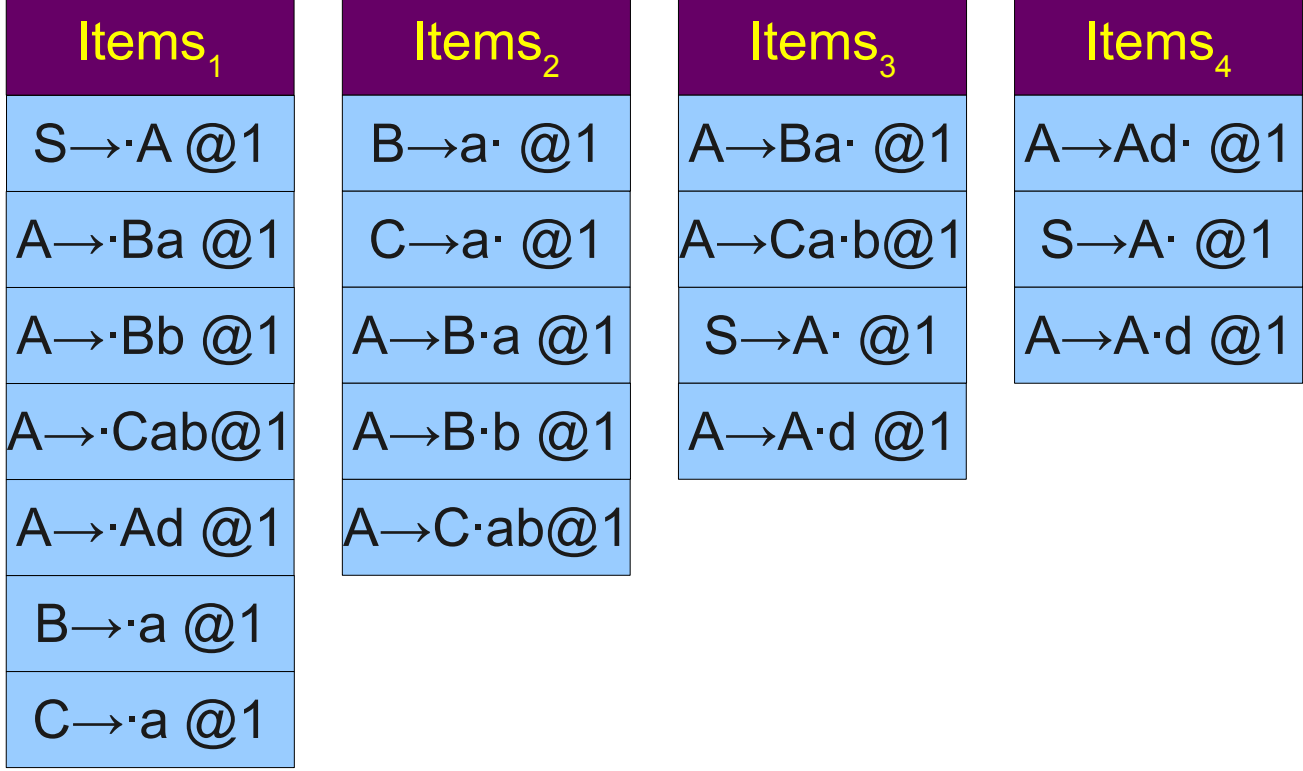

$S \rightarrow A$
 $A \rightarrow Ba$
 $A \rightarrow Bb$
 $A \rightarrow Cab$
 $A \rightarrow Ad$
 $B \rightarrow a$
 $C \rightarrow a$

An Observation

SCAN
 COMPLETE
 PREDICT

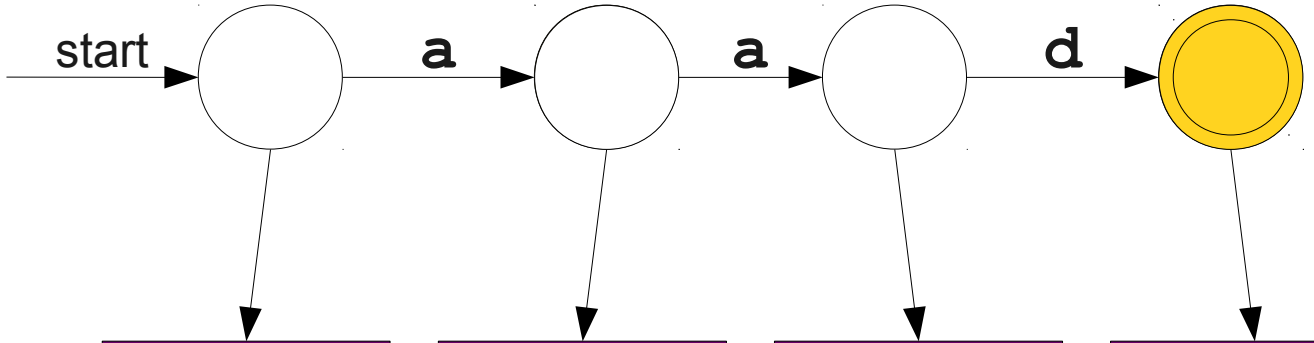

$B_{1-2} \rightarrow a_{1-2}$
 $C_{1-2} \rightarrow a_{1-2}$
 $A_{1-3} \rightarrow B_{1-2} a_{2-3}$
 $S_{1-3} \rightarrow A_{1-3}$
 $A_{1-4} \rightarrow A_{1-3} d_{3-4}$
 $S_{1-4} \rightarrow A_{1-4}$

Items ₁	Items ₂	Items ₃	Items ₄
$S \rightarrow \cdot A @1$	$B \rightarrow a \cdot @1$	$A \rightarrow Ba \cdot @1$	$A \rightarrow Ad \cdot @1$
$A \rightarrow \cdot Ba @1$	$C \rightarrow a \cdot @1$	$A \rightarrow Ca \cdot b @1$	$S \rightarrow A \cdot @1$
$A \rightarrow \cdot Bb @1$	$A \rightarrow B \cdot a @1$	$S \rightarrow A \cdot @1$	$A \rightarrow A \cdot d @1$
$A \rightarrow \cdot Cab @1$	$A \rightarrow B \cdot b @1$	$A \rightarrow A \cdot d @1$	
$A \rightarrow \cdot Ad @1$	$A \rightarrow C \cdot ab @1$		
$B \rightarrow \cdot a @1$			
$C \rightarrow \cdot a @1$			

$S \rightarrow A$
 $A \rightarrow Ba$
 $A \rightarrow Bb$
 $A \rightarrow Cab$
 $A \rightarrow Ad$
 $B \rightarrow a$
 $C \rightarrow a$

An Observation

SCAN
 COMPLETE
 PREDICT

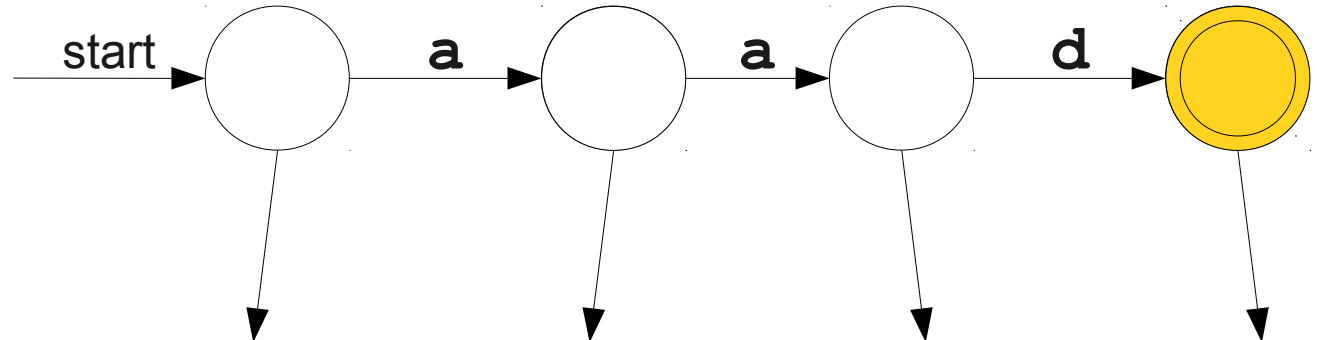

$B_{1-2} \rightarrow a_{1-2}$
 $C_{1-2} \rightarrow a_{1-2}$
 $A_{1-3} \rightarrow B_{1-2} a_{2-3}$
 $S_{1-3} \rightarrow A_{1-3}$
 $A_{1-4} \rightarrow A_{1-3} d_{3-4}$
 $S_{1-4} \rightarrow A_{1-4}$

Items ₁	Items ₂	Items ₃	Items ₄
$S \rightarrow \cdot A @1$	$B \rightarrow a \cdot @1$	$A \rightarrow Ba \cdot @1$	$A \rightarrow Ad \cdot @1$
$A \rightarrow \cdot Ba @1$	$C \rightarrow a \cdot @1$	$A \rightarrow Ca \cdot b @1$	$S \rightarrow A \cdot @1$
$A \rightarrow \cdot Bb @1$	$A \rightarrow B \cdot a @1$	$S \rightarrow A \cdot @1$	$A \rightarrow A \cdot d @1$
$A \rightarrow \cdot Cab @1$	$A \rightarrow B \cdot b @1$	$A \rightarrow A \cdot d @1$	
$A \rightarrow \cdot Ad @1$	$A \rightarrow C \cdot ab @1$		
$B \rightarrow \cdot a @1$			
$C \rightarrow \cdot a @1$			

$S \rightarrow A$
 $A \rightarrow Ba$
 $A \rightarrow Bb$
 $A \rightarrow Cab$
 $A \rightarrow Ad$
 $B \rightarrow a$
 $C \rightarrow a$

An Observation

SCAN
 COMPLETE
 PREDICT

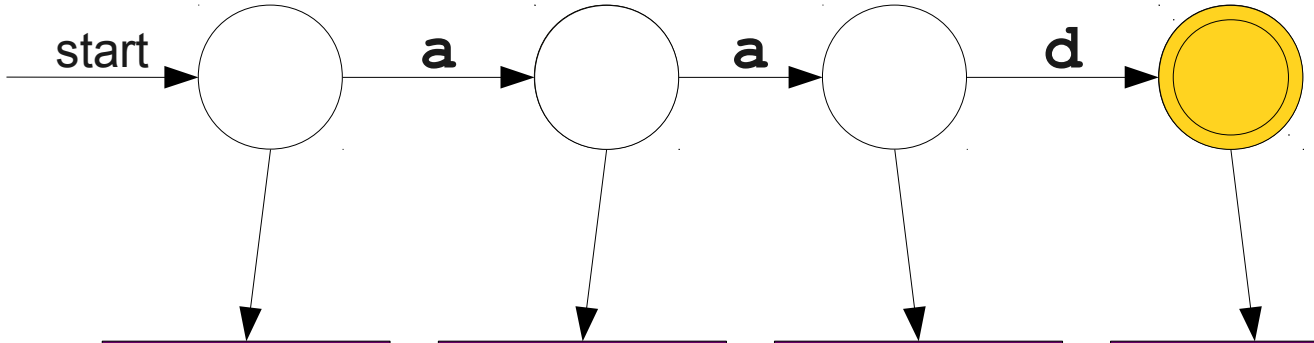

$B_{1-2} \rightarrow a_{1-2}$
 $C_{1-2} \rightarrow a_{1-2}$
 $A_{1-3} \rightarrow B_{1-2} a_{2-3}$
 $S_{1-3} \rightarrow A_{1-3}$
 $A_{1-4} \rightarrow A_{1-3} d_{3-4}$
 $S_{1-4} \rightarrow A_{1-4}$

Items ₁	Items ₂	Items ₃	Items ₄
$S \rightarrow \cdot A @1$	$B \rightarrow a \cdot @1$	$A \rightarrow Ba \cdot @1$	$A \rightarrow Ad \cdot @1$
$A \rightarrow \cdot Ba @1$	$C \rightarrow a \cdot @1$	$A \rightarrow Ca \cdot b @1$	$S \rightarrow A \cdot @1$
$A \rightarrow \cdot Bb @1$	$A \rightarrow B \cdot a @1$	$S \rightarrow A \cdot @1$	$A \rightarrow A \cdot d @1$
$A \rightarrow \cdot Cab @1$	$A \rightarrow B \cdot b @1$	$A \rightarrow A \cdot d @1$	
$A \rightarrow \cdot Ad @1$	$A \rightarrow C \cdot ab @1$		
$B \rightarrow \cdot a @1$			
$C \rightarrow \cdot a @1$			

$S \rightarrow A$
 $A \rightarrow Ba$
 $A \rightarrow Bb$
 $A \rightarrow Cab$
 $A \rightarrow Ad$
 $B \rightarrow a$
 $C \rightarrow a$

An Observation

SCAN
 COMPLETE
 PREDICT

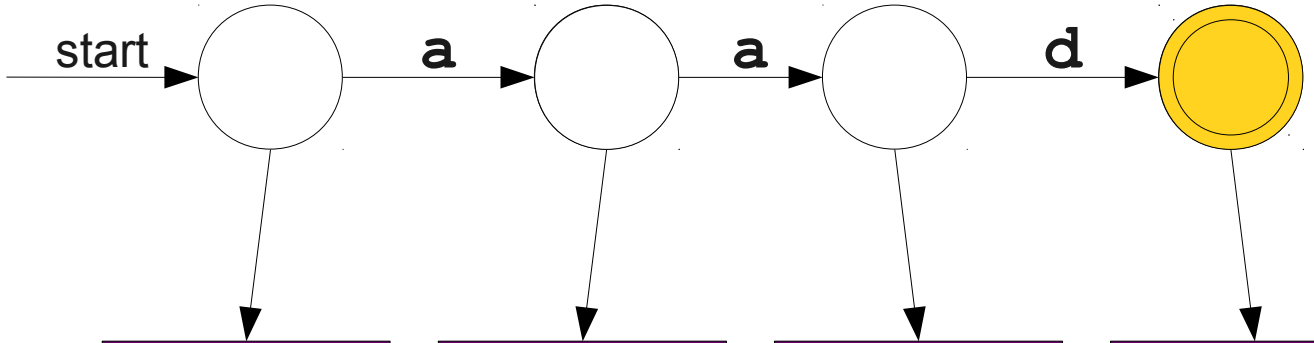

$B_{1-2} \rightarrow a_{1-2}$
 $C_{1-2} \rightarrow a_{1-2}$
 $A_{1-3} \rightarrow B_{1-2} a_{2-3}$
 $S_{1-3} \rightarrow A_{1-3}$
 $A_{1-4} \rightarrow A_{1-3} d_{3-4}$
 $S_{1-4} \rightarrow A_{1-4}$
 $S \rightarrow S_{1-4}$

Items ₁	Items ₂	Items ₃	Items ₄
$S \rightarrow \cdot A @1$	$B \rightarrow a \cdot @1$	$A \rightarrow Ba \cdot @1$	$A \rightarrow Ad \cdot @1$
$A \rightarrow \cdot Ba @1$	$C \rightarrow a \cdot @1$	$A \rightarrow Ca \cdot b @1$	$S \rightarrow A \cdot @1$
$A \rightarrow \cdot Bb @1$	$A \rightarrow B \cdot a @1$	$S \rightarrow A \cdot @1$	$A \rightarrow A \cdot d @1$
$A \rightarrow \cdot Cab @1$	$A \rightarrow B \cdot b @1$	$A \rightarrow A \cdot d @1$	
$A \rightarrow \cdot Ad @1$	$A \rightarrow C \cdot ab @1$		
$B \rightarrow \cdot a @1$			
$C \rightarrow \cdot a @1$			

What Just Happened?

- The input to the Earley parser is a context-free grammar and a string.
- We can think of that string as a **finite automaton** rather than a string.
- The output of the Earley parser is context-free grammar describing all valid ways of parsing the string.
- We can think of this as a context-free grammar for the **subset of the input grammar** that is accepted by the automaton.
- **What happens when we supply an arbitrary automaton?**

Parsing as Intersection

- We can think of parsing as computing the **intersection** of a **context-free language** and a **regular language**.
- Result from automata theory: This intersection is always a context-free language.
- Earley parsing is a **constructive algorithm** for finding this intersection (after some minor modifications).

Interpreting the Intersection

- As a **parse forest grammar**.
 - The output grammar describes all possible parse trees that would be accepted by the automaton.
- As a **filtered grammar**.
 - The output grammar is the input grammar “filtered” to just those strings matched by the automaton.

Why is this Interesting?

Why is this Interesting?

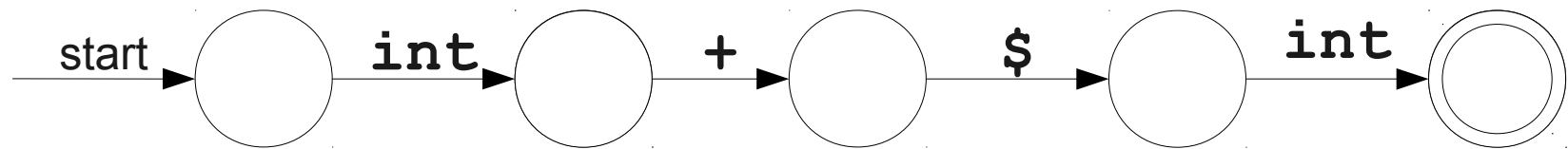

Why is this Interesting?

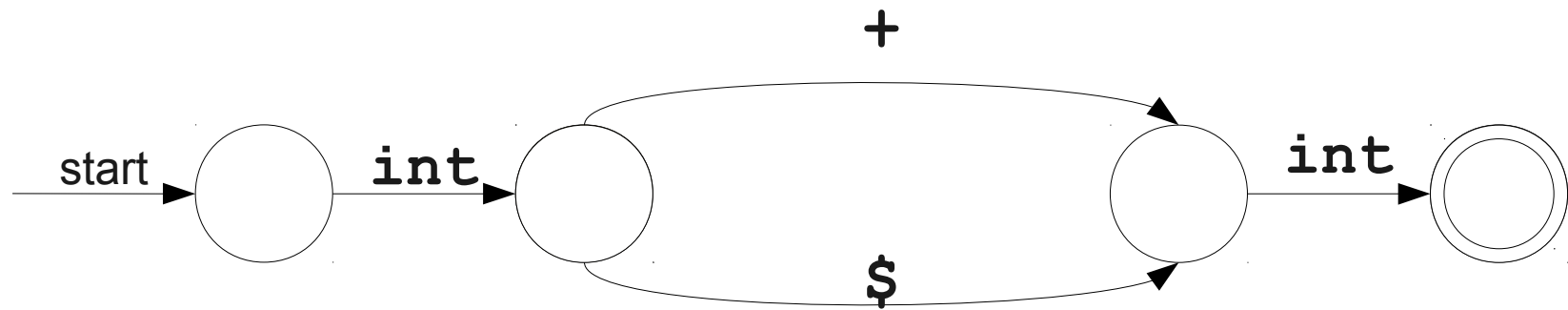

Why is this Interesting?

Why is this Interesting?

```
public class identifier { .* }
```

Why is this Interesting?

Why is this Interesting?

Parsing as intersection immediately provides polynomial-time algorithms for tasks that would seem problematic otherwise [...] without imposing restrictions on the CF grammar used in the parsing. Although its basic component is old, it is a relatively new and little-studied subject[.]

- Grune and Jacobs, pg 441

What Needs to Change?

- **Completer** and **predictor** steps are both fine.
- **Scanner** step needs to work across transitions, not from character-to-character.
- More formally:
 - For each item $A \rightarrow u \cdot tv @n$ in the k th item set, if there is a transition on t from state k to state j , add $A \rightarrow ut \cdot v @n$ to the j th item set.
- Additionally, accept if **any accepting state** has the item $S \rightarrow E \cdot @1$.
- **Cannot scan from left-to-right**; must consider all sets on each iteration.

A Simple Question

- Given the (ambiguous) grammar

$$S \rightarrow E$$
$$E \rightarrow E + E$$
$$E \rightarrow \text{int}$$
$$E \rightarrow (E)$$

- Determine whether there is some string generated by the grammar that has the form $(??)$, where $?$ represents any symbol in the grammar.

Our Automaton

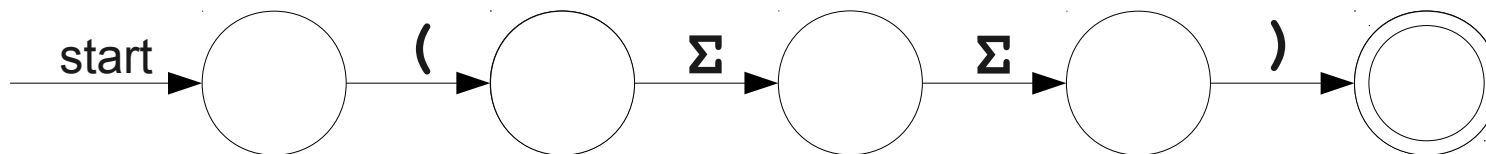

$S \rightarrow E$
 $E \rightarrow E + E$
 $E \rightarrow \text{int}$
 $E \rightarrow (E)$

Earley on DFAs

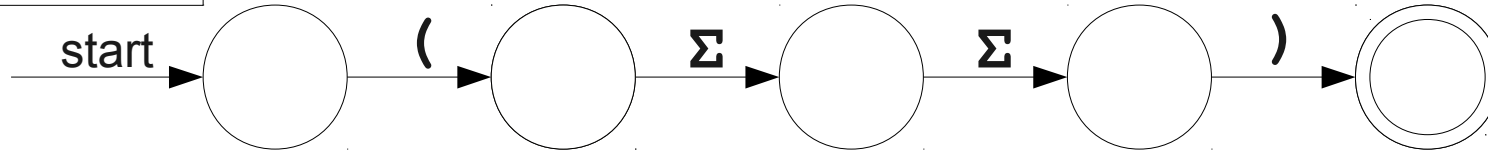

$S \rightarrow E$
 $E \rightarrow E + E$
 $E \rightarrow \text{int}$
 $E \rightarrow (E)$

Earley on DFAs

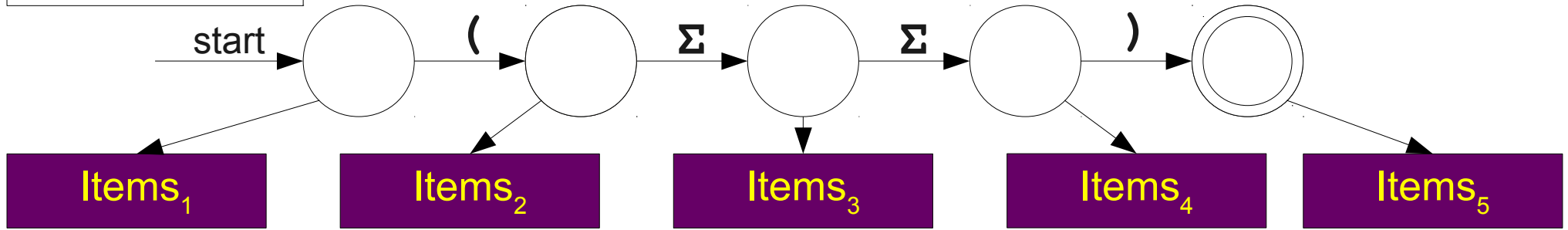

$S \rightarrow E$
 $E \rightarrow E + E$
 $E \rightarrow \text{int}$
 $E \rightarrow (E)$

Earley on DFAs

SCAN
COMPLETE
PREDICT

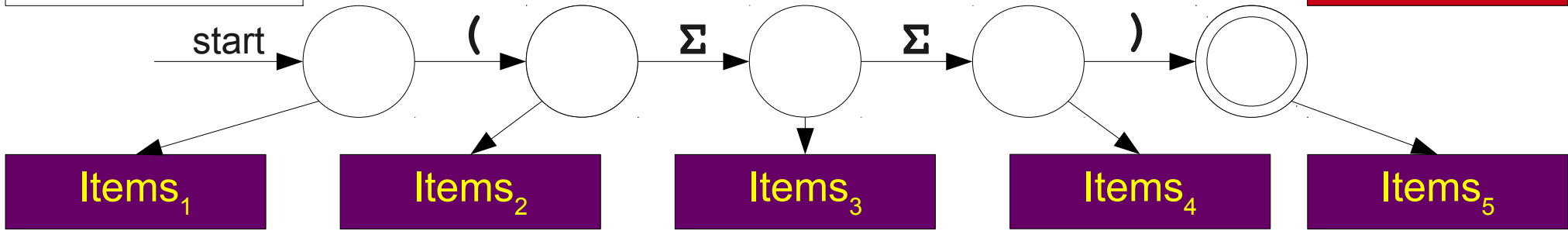

$S \rightarrow E$
 $E \rightarrow E + E$
 $E \rightarrow \text{int}$
 $E \rightarrow (E)$

Earley on DFAs

SCAN
 COMPLETE
 PREDICT

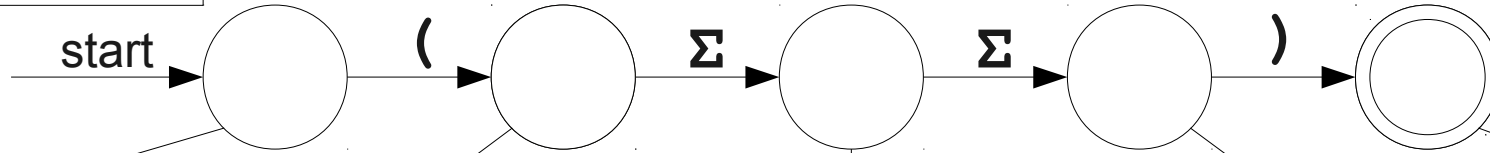

Items₁
 $S \rightarrow \cdot E @1$

Items₂

Items₃

Items₄

Items₅

$S \rightarrow E$
 $E \rightarrow E + E$
 $E \rightarrow \text{int}$
 $E \rightarrow (E)$

Earley on DFAs

SCAN
 COMPLETE
 PREDICT

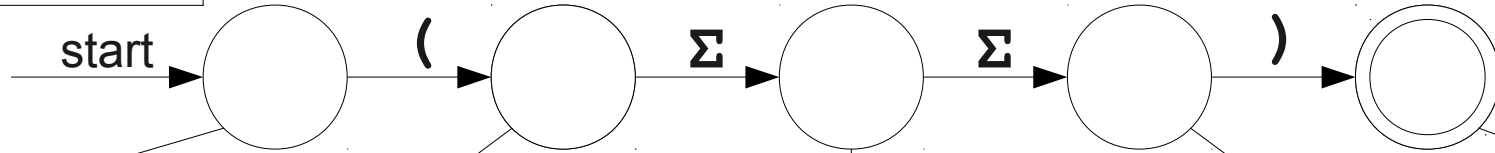

Items₁
 $S \rightarrow \cdot E @1$

Items₂

Items₃

Items₄

Items₅

$S \rightarrow E$
 $E \rightarrow E + E$
 $E \rightarrow \text{int}$
 $E \rightarrow (E)$

Earley on DFAs

SCAN
 COMPLETE
 PREDICT

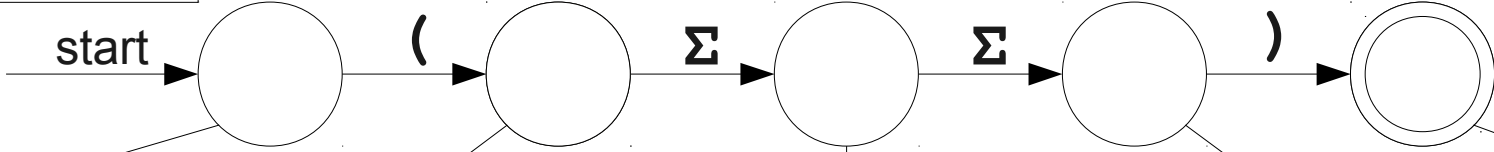

- Items₁**
- $S \rightarrow \cdot E @1$
 - $E \rightarrow \cdot E + E @1$
 - $E \rightarrow \cdot (E) @1$
 - $E \rightarrow \cdot \text{int} @1$

Items₂

Items₃

Items₄

Items₅

$S \rightarrow E$
 $E \rightarrow E + E$
 $E \rightarrow \text{int}$
 $E \rightarrow (E)$

Earley on DFAs

SCAN
 COMPLETE
 PREDICT

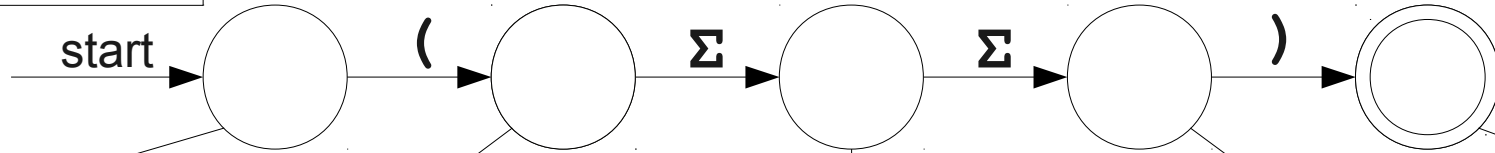

Items ₁
$S \rightarrow \cdot E @1$
$E \rightarrow \cdot E + E @1$
$E \rightarrow \cdot (E) @1$
$E \rightarrow \cdot \text{int} @1$

Items₂

Items₃

Items₄

Items₅

$S \rightarrow E$
 $E \rightarrow E + E$
 $E \rightarrow \text{int}$
 $E \rightarrow (E)$

Earley on DFAs

SCAN
 COMPLETE
 PREDICT

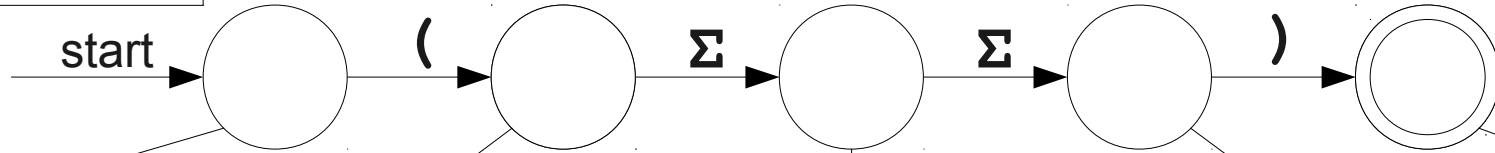

Items₁
 $S \rightarrow \cdot E @1$
 $E \rightarrow \cdot E + E @1$
 $E \rightarrow \cdot (E) @1$
 $E \rightarrow \cdot \text{int} @1$

Items₂
 $E \rightarrow (\cdot E) @1$

Items₃

Items₄

Items₅

$S \rightarrow E$
 $E \rightarrow E + E$
 $E \rightarrow \text{int}$
 $E \rightarrow (E)$

Earley on DFAs

SCAN
 COMPLETE
 PREDICT

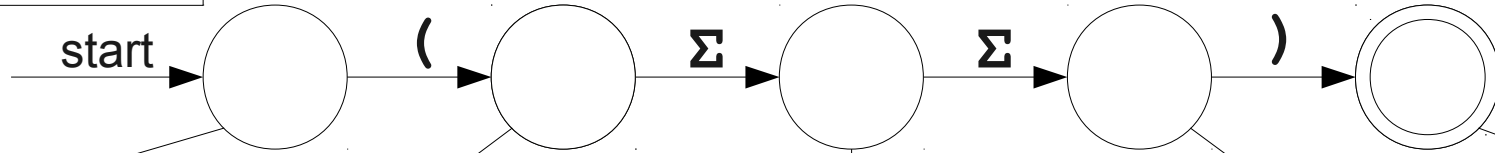

Items₁
 $S \rightarrow \cdot E @1$
 $E \rightarrow \cdot E + E @1$
 $E \rightarrow \cdot (E) @1$
 $E \rightarrow \cdot \text{int} @1$

Items₂
 $E \rightarrow (\cdot E) @1$

Items₃

Items₄

Items₅

$S \rightarrow E$
 $E \rightarrow E + E$
 $E \rightarrow \text{int}$
 $E \rightarrow (E)$

Earley on DFAs

SCAN
 COMPLETE
 PREDICT

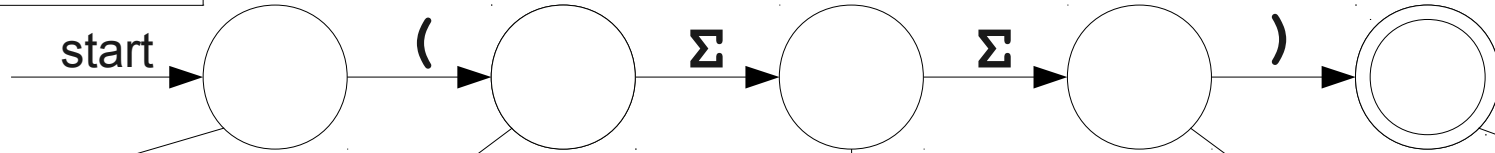

Items₁
 $S \rightarrow \cdot E @1$
 $E \rightarrow \cdot E + E @1$
 $E \rightarrow \cdot (E) @1$
 $E \rightarrow \cdot \text{int} @1$

Items₂
 $E \rightarrow (\cdot E) @1$

Items₃

Items₄

Items₅

$S \rightarrow E$
 $E \rightarrow E + E$
 $E \rightarrow \text{int}$
 $E \rightarrow (E)$

Earley on DFAs

SCAN
 COMPLETE
 PREDICT

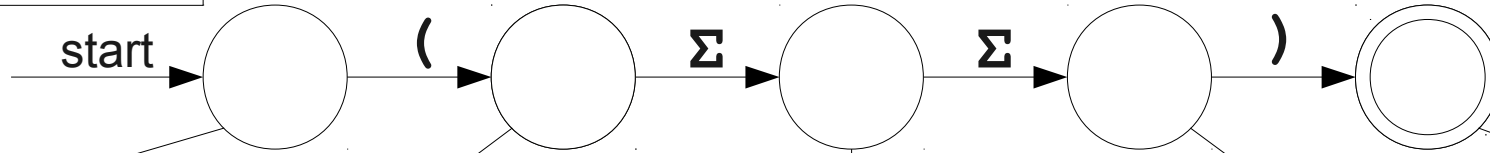

Items ₁
$S \rightarrow \cdot E @1$
$E \rightarrow \cdot E + E @1$
$E \rightarrow \cdot (E) @1$
$E \rightarrow \cdot \text{int} @1$

Items ₂
$E \rightarrow (\cdot E) @1$
$E \rightarrow \cdot E + E @2$
$E \rightarrow \cdot (E) @2$
$E \rightarrow \cdot \text{int} @2$

Items ₃

Items ₄

Items ₅

$S \rightarrow E$
 $E \rightarrow E + E$
 $E \rightarrow \text{int}$
 $E \rightarrow (E)$

Earley on DFAs

SCAN
 COMPLETE
 PREDICT

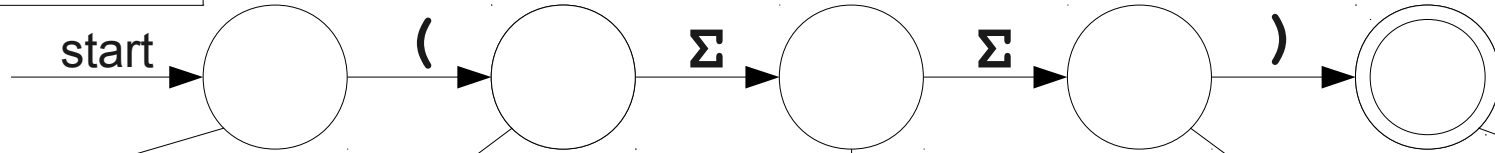

Items₁

$S \rightarrow \cdot E @1$
$E \rightarrow \cdot E + E @1$
$E \rightarrow \cdot (E) @1$
$E \rightarrow \cdot \text{int} @1$

Items₂

$E \rightarrow (\cdot E) @1$
$E \rightarrow \cdot E + E @2$
$E \rightarrow \cdot (E) @2$
$E \rightarrow \cdot \text{int} @2$

Items₃

Items₄

Items₅

$S \rightarrow E$
 $E \rightarrow E + E$
 $E \rightarrow \text{int}$
 $E \rightarrow (E)$

Earley on DFAs

SCAN
 COMPLETE
 PREDICT

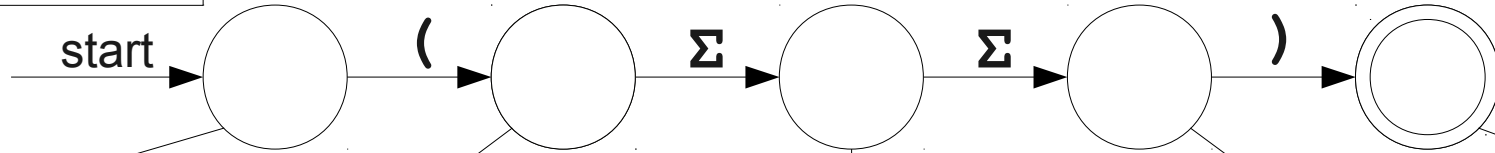

Items ₁
$S \rightarrow \cdot E @1$
$E \rightarrow \cdot E + E @1$
$E \rightarrow \cdot (E) @1$
$E \rightarrow \cdot \text{int} @1$

Items ₂
$E \rightarrow (\cdot E) @1$
$E \rightarrow \cdot E + E @2$
$E \rightarrow \cdot (E) @2$
$E \rightarrow \cdot \text{int} @2$

Items ₃
$E \rightarrow (\cdot E) @2$
$E \rightarrow \text{int} \cdot @2$

Items ₄

Items ₅

$S \rightarrow E$
 $E \rightarrow E + E$
 $E \rightarrow \text{int}$
 $E \rightarrow (E)$

Earley on DFAs

SCAN
 COMPLETE
 PREDICT

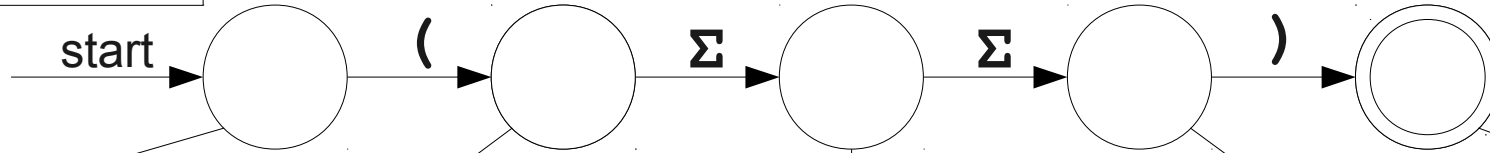

Items₁

$S \rightarrow \cdot E @1$
$E \rightarrow \cdot E + E @1$
$E \rightarrow \cdot (E) @1$
$E \rightarrow \cdot \text{int} @1$

Items₂

$E \rightarrow (\cdot E) @1$
$E \rightarrow \cdot E + E @2$
$E \rightarrow \cdot (E) @2$
$E \rightarrow \cdot \text{int} @2$

Items₃

$E \rightarrow (\cdot E) @2$
$E \rightarrow \text{int} \cdot @2$

Items₄

Items₅

$S \rightarrow E$
 $E \rightarrow E + E$
 $E \rightarrow \text{int}$
 $E \rightarrow (E)$

Earley on DFAs

SCAN
 COMPLETE
 PREDICT

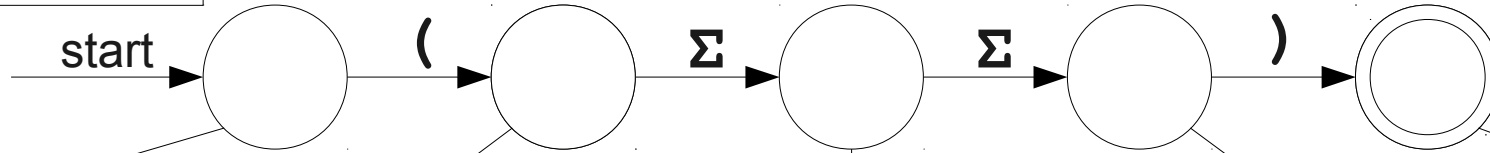

Items₁

$S \rightarrow \cdot E @1$
$E \rightarrow \cdot E + E @1$
$E \rightarrow \cdot (E) @1$
$E \rightarrow \cdot \text{int} @1$

Items₂

$E \rightarrow (\cdot E) @1$
$E \rightarrow \cdot E + E @2$
$E \rightarrow \cdot (E) @2$
$E \rightarrow \cdot \text{int} @2$

Items₃

$E \rightarrow (\cdot E) @2$
$E \rightarrow \text{int} \cdot @2$
$E \rightarrow (E \cdot) @1$
$E \rightarrow E \cdot + E @2$

Items₄

Items₅

$S \rightarrow E$
 $E \rightarrow E + E$
 $E \rightarrow \text{int}$
 $E \rightarrow (E)$

Earley on DFAs

SCAN
 COMPLETE
 PREDICT

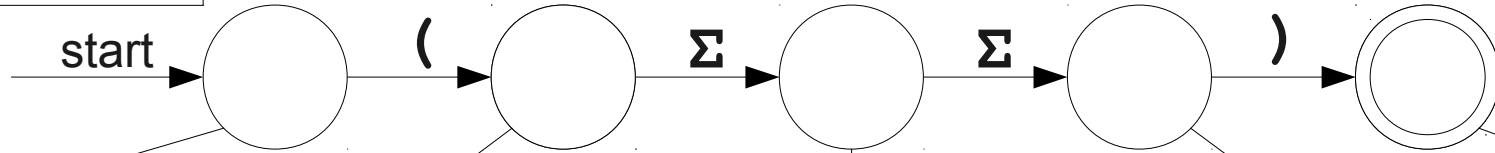

Items ₁
$S \rightarrow \cdot E @1$
$E \rightarrow \cdot E + E @1$
$E \rightarrow \cdot (E) @1$
$E \rightarrow \cdot \text{int} @1$

Items ₂
$E \rightarrow (\cdot E) @1$
$E \rightarrow \cdot E + E @2$
$E \rightarrow \cdot (E) @2$
$E \rightarrow \cdot \text{int} @2$

Items ₃
$E \rightarrow (\cdot E) @2$
$E \rightarrow \text{int} \cdot @2$
$E \rightarrow (E \cdot) @1$
$E \rightarrow E \cdot + E @2$

Items ₄

Items ₅

$S \rightarrow E$
 $E \rightarrow E + E$
 $E \rightarrow \text{int}$
 $E \rightarrow (E)$

Earley on DFAs

SCAN
 COMPLETE
 PREDICT

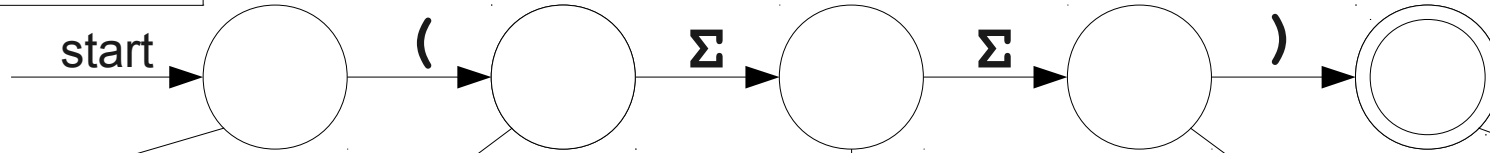

Items₁

$S \rightarrow \cdot E @1$
$E \rightarrow \cdot E + E @1$
$E \rightarrow \cdot (E) @1$
$E \rightarrow \cdot \text{int} @1$

Items₂

$E \rightarrow (\cdot E) @1$
$E \rightarrow \cdot E + E @2$
$E \rightarrow \cdot (E) @2$
$E \rightarrow \cdot \text{int} @2$

Items₃

$E \rightarrow (\cdot E) @2$
$E \rightarrow \text{int} \cdot @2$
$E \rightarrow (E \cdot) @1$
$E \rightarrow E \cdot + E @2$
$E \rightarrow \cdot E + E @3$
$E \rightarrow \cdot (E) @3$
$E \rightarrow \cdot \text{int} @3$

Items₄

Items₅

$S \rightarrow E$
 $E \rightarrow E + E$
 $E \rightarrow \text{int}$
 $E \rightarrow (E)$

Earley on DFAs

SCAN
 COMPLETE
 PREDICT

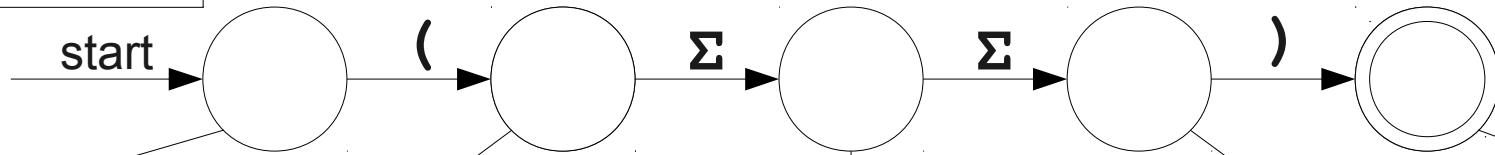

Items₁

$S \rightarrow \cdot E @1$
$E \rightarrow \cdot E + E @1$
$E \rightarrow \cdot (E) @1$
$E \rightarrow \cdot \text{int} @1$

Items₂

$E \rightarrow (\cdot E) @1$
$E \rightarrow \cdot E + E @2$
$E \rightarrow \cdot (E) @2$
$E \rightarrow \cdot \text{int} @2$

Items₃

$E \rightarrow (\cdot E) @2$
$E \rightarrow \text{int} \cdot @2$
$E \rightarrow (E \cdot) @1$
$E \rightarrow E \cdot + E @2$
$E \rightarrow \cdot E + E @3$
$E \rightarrow \cdot (E) @3$
$E \rightarrow \cdot \text{int} @3$

Items₄

Items₅

$S \rightarrow E$
 $E \rightarrow E + E$
 $E \rightarrow \text{int}$
 $E \rightarrow (E)$

Earley on DFAs

SCAN
 COMPLETE
 PREDICT

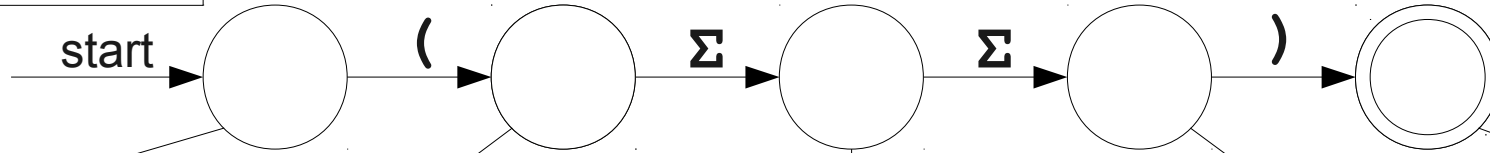

Items₁

$S \rightarrow \cdot E @1$
$E \rightarrow \cdot E + E @1$
$E \rightarrow \cdot (E) @1$
$E \rightarrow \cdot \text{int} @1$

Items₂

$E \rightarrow (\cdot E) @1$
$E \rightarrow \cdot E + E @2$
$E \rightarrow \cdot (E) @2$
$E \rightarrow \cdot \text{int} @2$

Items₃

$E \rightarrow (\cdot E) @2$
$E \rightarrow \text{int} \cdot @2$
$E \rightarrow (E \cdot) @1$
$E \rightarrow E \cdot + E @2$
$E \rightarrow \cdot E + E @3$
$E \rightarrow \cdot (E) @3$
$E \rightarrow \cdot \text{int} @3$

Items₄

$E \rightarrow (E) \cdot @1$
$E \rightarrow (\cdot E) @3$
$E \rightarrow \text{int} \cdot @3$
$E \rightarrow E + \cdot E @2$

Items₅

$S \rightarrow E$
 $E \rightarrow E + E$
 $E \rightarrow \text{int}$
 $E \rightarrow (E)$

Earley on DFAs

SCAN
 COMPLETE
 PREDICT

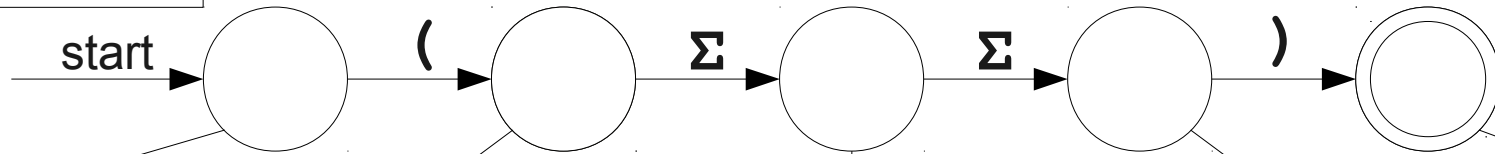

Items₁

$S \rightarrow \cdot E @1$
$E \rightarrow \cdot E + E @1$
$E \rightarrow \cdot (E) @1$
$E \rightarrow \cdot \text{int} @1$

Items₂

$E \rightarrow (\cdot E) @1$
$E \rightarrow \cdot E + E @2$
$E \rightarrow \cdot (E) @2$
$E \rightarrow \cdot \text{int} @2$

Items₃

$E \rightarrow (\cdot E) @2$
$E \rightarrow \text{int} \cdot @2$
$E \rightarrow (E \cdot) @1$
$E \rightarrow E \cdot + E @2$
$E \rightarrow \cdot E + E @3$
$E \rightarrow \cdot (E) @3$
$E \rightarrow \cdot \text{int} @3$

Items₄

$E \rightarrow (E) \cdot @1$
$E \rightarrow (\cdot E) @3$
$E \rightarrow \text{int} \cdot @3$
$E \rightarrow E + \cdot E @2$

Items₅

$S \rightarrow E$
 $E \rightarrow E + E$
 $E \rightarrow \text{int}$
 $E \rightarrow (E)$

Earley on DFAs

SCAN
 COMPLETE
 PREDICT

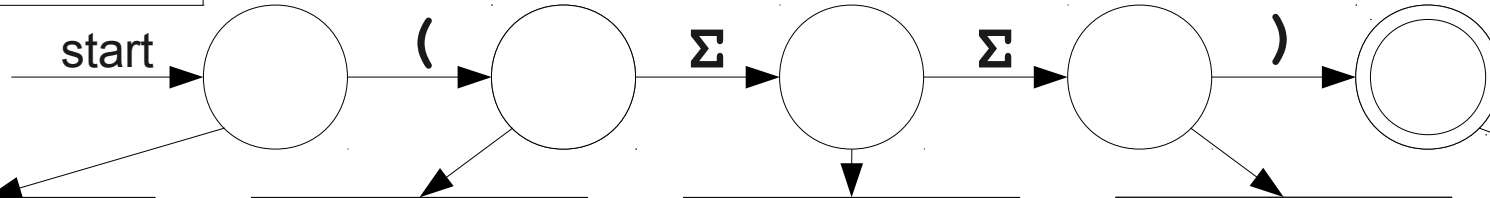

Items₁

$S \rightarrow \cdot E @1$
$E \rightarrow \cdot E + E @1$
$E \rightarrow \cdot (E) @1$
$E \rightarrow \cdot \text{int} @1$

Items₂

$E \rightarrow (\cdot E) @1$
$E \rightarrow \cdot E + E @2$
$E \rightarrow \cdot (E) @2$
$E \rightarrow \cdot \text{int} @2$

Items₃

$E \rightarrow (\cdot E) @2$
$E \rightarrow \text{int} \cdot @2$
$E \rightarrow (E \cdot) @1$
$E \rightarrow E \cdot + E @2$
$E \rightarrow \cdot E + E @3$
$E \rightarrow \cdot (E) @3$
$E \rightarrow \cdot \text{int} @3$

Items₄

$E \rightarrow (E) \cdot @1$
$E \rightarrow (\cdot E) @3$
$E \rightarrow \text{int} \cdot @3$
$E \rightarrow E + \cdot E @2$
$S \rightarrow E \cdot @1$
$E \rightarrow E \cdot + E @1$

Items₅

$S \rightarrow E$
 $E \rightarrow E + E$
 $E \rightarrow \text{int}$
 $E \rightarrow (E)$

Earley on DFAs

SCAN
 COMPLETE
 PREDICT

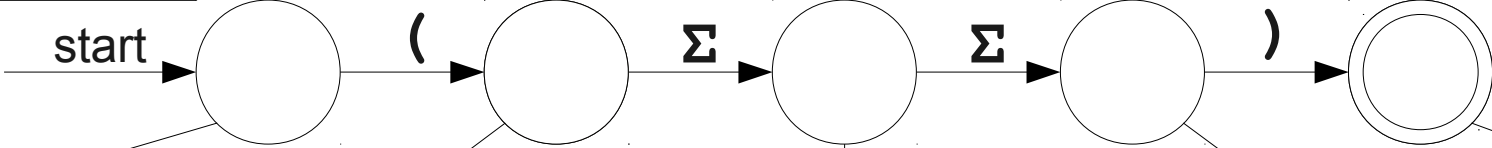

Items₁

$S \rightarrow \cdot E @1$
$E \rightarrow \cdot E + E @1$
$E \rightarrow \cdot (E) @1$
$E \rightarrow \cdot \text{int} @1$

Items₂

$E \rightarrow (\cdot E) @1$
$E \rightarrow \cdot E + E @2$
$E \rightarrow \cdot (E) @2$
$E \rightarrow \cdot \text{int} @2$

Items₃

$E \rightarrow (\cdot E) @2$
$E \rightarrow \text{int} \cdot @2$
$E \rightarrow (E \cdot) @1$
$E \rightarrow E \cdot + E @2$
$E \rightarrow \cdot E + E @3$
$E \rightarrow \cdot (E) @3$
$E \rightarrow \cdot \text{int} @3$

Items₄

$E \rightarrow (E) \cdot @1$
$E \rightarrow (\cdot E) @3$
$E \rightarrow \text{int} \cdot @3$
$E \rightarrow E + \cdot E @2$
$S \rightarrow E \cdot @1$
$E \rightarrow E \cdot + E @1$
$E \rightarrow (E \cdot) @2$
$E \rightarrow E \cdot + E @3$

Items₅

$S \rightarrow E$
 $E \rightarrow E + E$
 $E \rightarrow \text{int}$
 $E \rightarrow (E)$

Earley on DFAs

SCAN
 COMPLETE
 PREDICT

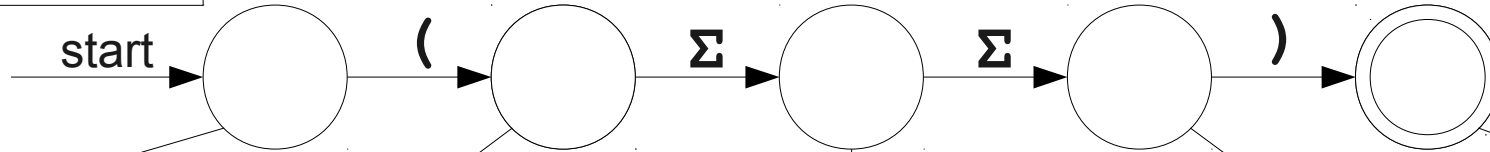

Items₁

$S \rightarrow \cdot E @1$
$E \rightarrow \cdot E + E @1$
$E \rightarrow \cdot (E) @1$
$E \rightarrow \cdot \text{int} @1$

Items₂

$E \rightarrow (\cdot E) @1$
$E \rightarrow \cdot E + E @2$
$E \rightarrow \cdot (E) @2$
$E \rightarrow \cdot \text{int} @2$

Items₃

$E \rightarrow (\cdot E) @2$
$E \rightarrow \text{int} \cdot @2$
$E \rightarrow (E \cdot) @1$
$E \rightarrow E \cdot + E @2$
$E \rightarrow \cdot E + E @3$
$E \rightarrow \cdot (E) @3$
$E \rightarrow \cdot \text{int} @3$

Items₄

$E \rightarrow (E) \cdot @1$
$E \rightarrow (\cdot E) @3$
$E \rightarrow \text{int} \cdot @3$
$E \rightarrow E + \cdot E @2$
$S \rightarrow E \cdot @1$
$E \rightarrow E \cdot + E @1$
$E \rightarrow (E \cdot) @2$
$E \rightarrow E \cdot + E @3$

Items₅

--

$S \rightarrow E$
 $E \rightarrow E + E$
 $E \rightarrow \text{int}$
 $E \rightarrow (E)$

Earley on DFAs

SCAN
 COMPLETE
 PREDICT

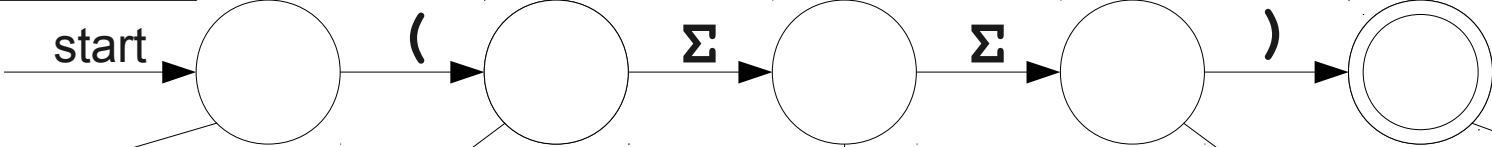

Items₁

$S \rightarrow \cdot E @1$
$E \rightarrow \cdot E + E @1$
$E \rightarrow \cdot (E) @1$
$E \rightarrow \cdot \text{int} @1$

Items₂

$E \rightarrow (\cdot E) @1$
$E \rightarrow \cdot E + E @2$
$E \rightarrow \cdot (E) @2$
$E \rightarrow \cdot \text{int} @2$

Items₃

$E \rightarrow (\cdot E) @2$
$E \rightarrow \text{int} \cdot @2$
$E \rightarrow (E \cdot) @1$
$E \rightarrow E \cdot + E @2$
$E \rightarrow \cdot E + E @3$
$E \rightarrow \cdot (E) @3$
$E \rightarrow \cdot \text{int} @3$

Items₄

$E \rightarrow (E) \cdot @1$
$E \rightarrow (\cdot E) @3$
$E \rightarrow \text{int} \cdot @3$
$E \rightarrow E + \cdot E @2$
$S \rightarrow E \cdot @1$
$E \rightarrow E \cdot + E @1$
$E \rightarrow (E \cdot) @2$
$E \rightarrow E \cdot + E @3$
$E \rightarrow \cdot E + E @4$
$E \rightarrow \cdot (E) @4$
$E \rightarrow \cdot \text{int} @4$

Items₅

$S \rightarrow E$
 $E \rightarrow E + E$
 $E \rightarrow \text{int}$
 $E \rightarrow (E)$

Earley on DFAs

SCAN
COMPLETE
PREDICT

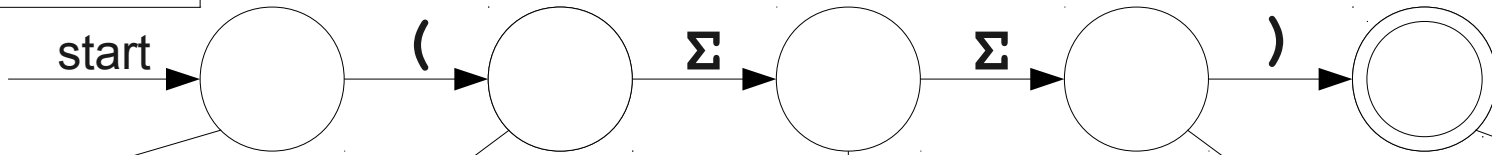

Items ₁
$S \rightarrow \cdot E @1$
$E \rightarrow \cdot E + E @1$
$E \rightarrow \cdot (E) @1$
$E \rightarrow \cdot \text{int} @1$

Items ₂
$E \rightarrow (\cdot E) @1$
$E \rightarrow \cdot E + E @2$
$E \rightarrow \cdot (E) @2$
$E \rightarrow \cdot \text{int} @2$

Items ₃
$E \rightarrow (\cdot E) @2$
$E \rightarrow \text{int} \cdot @2$
$E \rightarrow (E \cdot) @1$
$E \rightarrow E \cdot + E @2$
$E \rightarrow \cdot E + E @3$
$E \rightarrow \cdot (E) @3$
$E \rightarrow \cdot \text{int} @3$

Items ₄
$E \rightarrow (E) \cdot @1$
$E \rightarrow (\cdot E) @3$
$E \rightarrow \text{int} \cdot @3$
$E \rightarrow E + \cdot E @2$
$S \rightarrow E \cdot @1$
$E \rightarrow E \cdot + E @1$
$E \rightarrow (E \cdot) @2$
$E \rightarrow E \cdot + E @3$
$E \rightarrow \cdot E + E @4$
$E \rightarrow \cdot (E) @4$
$E \rightarrow \cdot \text{int} @4$

Items ₅

$S \rightarrow E$
 $E \rightarrow E + E$
 $E \rightarrow \text{int}$
 $E \rightarrow (E)$

Earley on DFAs

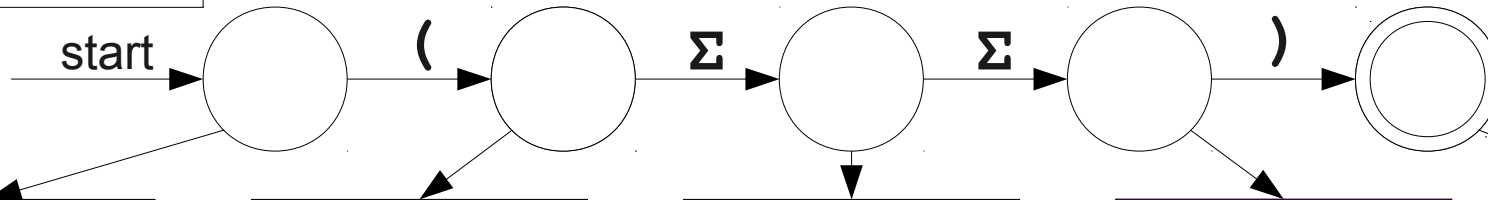
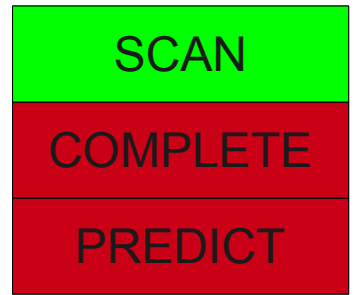

Items ₁
$S \rightarrow \cdot E @1$
$E \rightarrow \cdot E + E @1$
$E \rightarrow \cdot (E) @1$
$E \rightarrow \cdot \text{int} @1$

Items ₂
$E \rightarrow (\cdot E) @1$
$E \rightarrow \cdot E + E @2$
$E \rightarrow \cdot (E) @2$
$E \rightarrow \cdot \text{int} @2$

Items ₃
$E \rightarrow (\cdot E) @2$
$E \rightarrow \text{int} \cdot @2$
$E \rightarrow (E \cdot) @1$
$E \rightarrow E \cdot + E @2$
$E \rightarrow \cdot E + E @3$
$E \rightarrow \cdot (E) @3$
$E \rightarrow \cdot \text{int} @3$

Items ₄
$E \rightarrow (E) \cdot @1$
$E \rightarrow (\cdot E) @3$
$E \rightarrow \text{int} \cdot @3$
$E \rightarrow E + \cdot E @2$
$S \rightarrow E \cdot @1$
$E \rightarrow E \cdot + E @1$
$E \rightarrow (E \cdot) @2$
$E \rightarrow E \cdot + E @3$
$E \rightarrow \cdot E + E @4$
$E \rightarrow \cdot (E) @4$
$E \rightarrow \cdot \text{int} @4$

Items ₅
$E \rightarrow (E) \cdot @2$

$S \rightarrow E$
 $E \rightarrow E + E$
 $E \rightarrow \text{int}$
 $E \rightarrow (E)$

Earley on DFAs

SCAN
 COMPLETE
 PREDICT

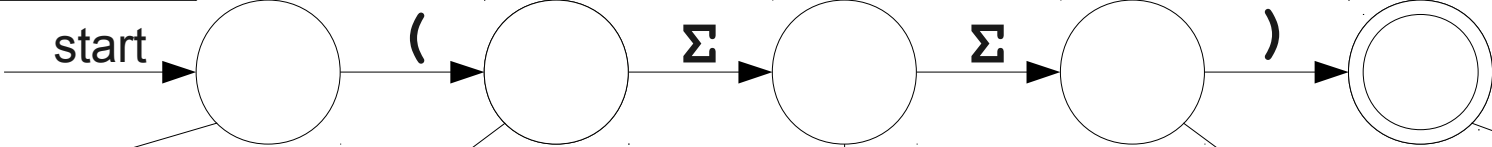

Items ₁
$S \rightarrow \cdot E @1$
$E \rightarrow \cdot E + E @1$
$E \rightarrow \cdot (E) @1$
$E \rightarrow \cdot \text{int} @1$

Items ₂
$E \rightarrow (\cdot E) @1$
$E \rightarrow \cdot E + E @2$
$E \rightarrow \cdot (E) @2$
$E \rightarrow \cdot \text{int} @2$

Items ₃
$E \rightarrow (\cdot E) @2$
$E \rightarrow \text{int} \cdot @2$
$E \rightarrow (E \cdot) @1$
$E \rightarrow E \cdot + E @2$
$E \rightarrow \cdot E + E @3$
$E \rightarrow \cdot (E) @3$
$E \rightarrow \cdot \text{int} @3$

Items ₄
$E \rightarrow (E) \cdot @1$
$E \rightarrow (\cdot E) @3$
$E \rightarrow \text{int} \cdot @3$
$E \rightarrow E + \cdot E @2$
$S \rightarrow E \cdot @1$
$E \rightarrow E \cdot + E @1$
$E \rightarrow (E \cdot) @2$
$E \rightarrow E \cdot + E @3$
$E \rightarrow \cdot E + E @4$
$E \rightarrow \cdot (E) @4$
$E \rightarrow \cdot \text{int} @4$

Items ₅
$E \rightarrow (E) \cdot @2$

$S \rightarrow E$
 $E \rightarrow E + E$
 $E \rightarrow \text{int}$
 $E \rightarrow (E)$

Earley on DFAs

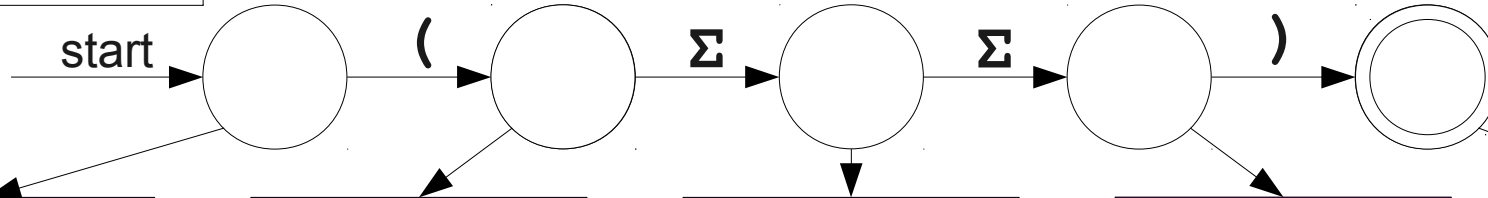
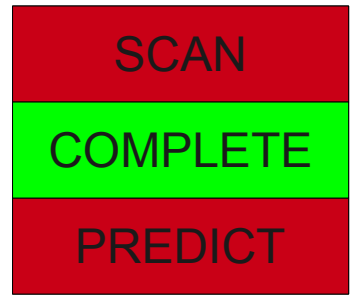

Items ₁
$S \rightarrow \cdot E @1$
$E \rightarrow \cdot E + E @1$
$E \rightarrow \cdot (E) @1$
$E \rightarrow \cdot \text{int} @1$

Items ₂
$E \rightarrow (\cdot E) @1$
$E \rightarrow \cdot E + E @2$
$E \rightarrow \cdot (E) @2$
$E \rightarrow \cdot \text{int} @2$

Items ₃
$E \rightarrow (\cdot E) @2$
$E \rightarrow \text{int} \cdot @2$
$E \rightarrow (E \cdot) @1$
$E \rightarrow E \cdot + E @2$
$E \rightarrow \cdot E + E @3$
$E \rightarrow \cdot (E) @3$
$E \rightarrow \cdot \text{int} @3$

Items ₄
$E \rightarrow (E) \cdot @1$
$E \rightarrow (\cdot E) @3$
$E \rightarrow \text{int} \cdot @3$
$E \rightarrow E + \cdot E @2$
$S \rightarrow E \cdot @1$
$E \rightarrow E \cdot + E @1$
$E \rightarrow (E \cdot) @2$
$E \rightarrow E \cdot + E @3$
$E \rightarrow \cdot E + E @4$
$E \rightarrow \cdot (E) @4$
$E \rightarrow \cdot \text{int} @4$

Items ₅
$E \rightarrow (E) \cdot @2$
$E \rightarrow (E \cdot) @1$
$E \rightarrow E \cdot + E @2$

$S \rightarrow E$
 $E \rightarrow E + E$
 $E \rightarrow \text{int}$
 $E \rightarrow (E)$

Earley on DFAs

SCAN
 COMPLETE
 PREDICT

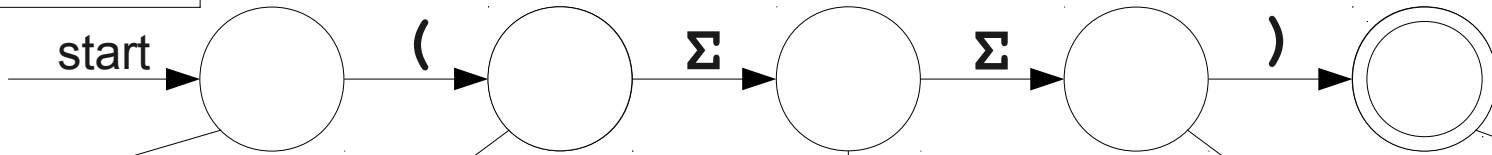

Items ₁
$S \rightarrow \cdot E @1$
$E \rightarrow \cdot E + E @1$
$E \rightarrow \cdot (E) @1$
$E \rightarrow \cdot \text{int} @1$

Items ₂
$E \rightarrow (\cdot E) @1$
$E \rightarrow \cdot E + E @2$
$E \rightarrow \cdot (E) @2$
$E \rightarrow \cdot \text{int} @2$

Items ₃
$E \rightarrow (\cdot E) @2$
$E \rightarrow \text{int} \cdot @2$
$E \rightarrow (E \cdot) @1$
$E \rightarrow E \cdot + E @2$
$E \rightarrow \cdot E + E @3$
$E \rightarrow \cdot (E) @3$
$E \rightarrow \cdot \text{int} @3$

Items ₄
$E \rightarrow (E) \cdot @1$
$E \rightarrow (\cdot E) @3$
$E \rightarrow \text{int} \cdot @3$
$E \rightarrow E + \cdot E @2$
$S \rightarrow E \cdot @1$
$E \rightarrow E \cdot + E @1$
$E \rightarrow (E \cdot) @2$
$E \rightarrow E \cdot + E @3$
$E \rightarrow \cdot E + E @4$
$E \rightarrow \cdot (E) @4$
$E \rightarrow \cdot \text{int} @4$

Items ₅
$E \rightarrow (E) \cdot @2$
$E \rightarrow (E \cdot) @1$
$E \rightarrow E \cdot + E @2$

$S \rightarrow E$
 $E \rightarrow E + E$
 $E \rightarrow \text{int}$
 $E \rightarrow (E)$

Earley on DFAs

SCAN
 COMPLETE
 PREDICT

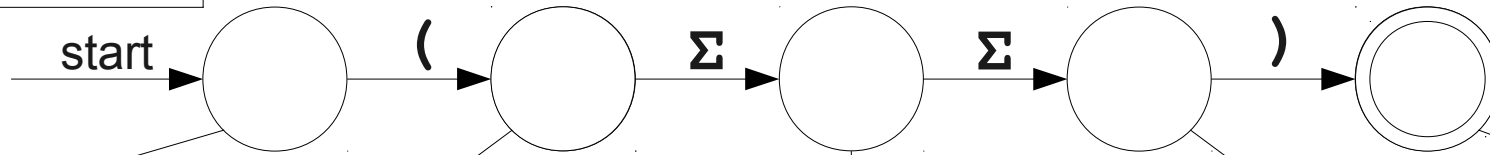

Items ₁
$S \rightarrow \cdot E @1$
$E \rightarrow \cdot E + E @1$
$E \rightarrow \cdot (E) @1$
$E \rightarrow \cdot \text{int} @1$

Items ₂
$E \rightarrow (\cdot E) @1$
$E \rightarrow \cdot E + E @2$
$E \rightarrow \cdot (E) @2$
$E \rightarrow \cdot \text{int} @2$

Items ₃
$E \rightarrow (\cdot E) @2$
$E \rightarrow \text{int} \cdot @2$
$E \rightarrow (E \cdot) @1$
$E \rightarrow E \cdot + E @2$
$E \rightarrow \cdot E + E @3$
$E \rightarrow \cdot (E) @3$
$E \rightarrow \cdot \text{int} @3$

Items ₄
$E \rightarrow (E) \cdot @1$
$E \rightarrow (\cdot E) @3$
$E \rightarrow \text{int} \cdot @3$
$E \rightarrow E + \cdot E @2$
$S \rightarrow E \cdot @1$
$E \rightarrow E \cdot + E @1$
$E \rightarrow (E \cdot) @2$
$E \rightarrow E \cdot + E @3$
$E \rightarrow \cdot E + E @4$
$E \rightarrow \cdot (E) @4$
$E \rightarrow \cdot \text{int} @4$

Items ₅
$E \rightarrow (E) \cdot @2$
$E \rightarrow (E \cdot) @1$
$E \rightarrow E \cdot + E @2$

Parsing DFAs

- Similar logic to parsing strings: build a parse forest grammar.
- Intuitively, filters grammar through DFA to produce a new grammar.
- Example: Filter grammar for expressions to only allow one pair of parentheses:

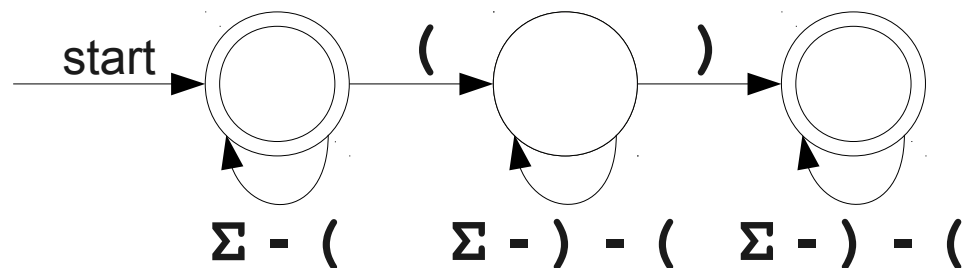

$S \rightarrow E$
 $E \rightarrow E + E$
 $E \rightarrow \text{int}$
 $E \rightarrow (E)$

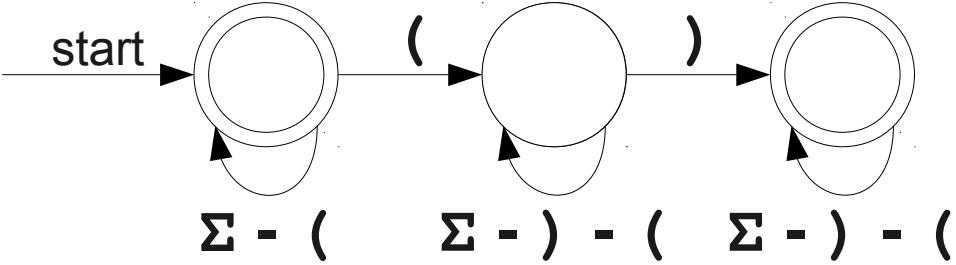

$S \rightarrow E$
 $E \rightarrow E + E$
 $E \rightarrow \text{int}$
 $E \rightarrow (E)$

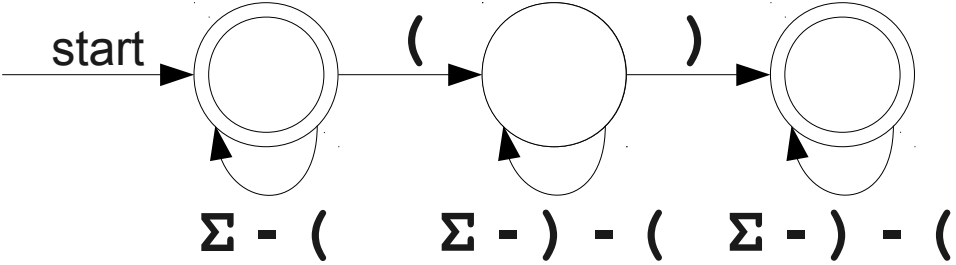

Items₁

Items₂

Items₃

$S \rightarrow E$
 $E \rightarrow E + E$
 $E \rightarrow \text{int}$
 $E \rightarrow (E)$

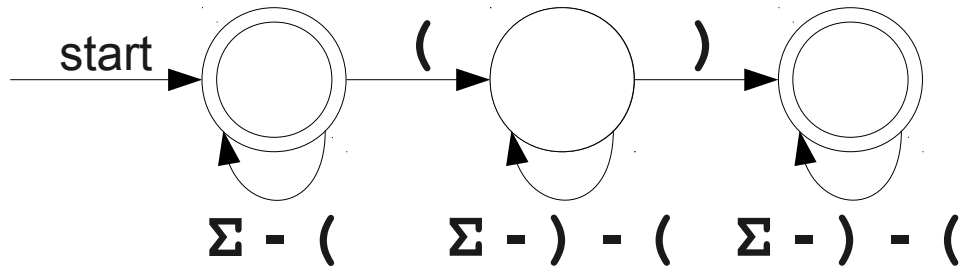

SCAN
 COMPLETE
 PREDICT

Items₁

Items₂

Items₃

$S \rightarrow E$
 $E \rightarrow E + E$
 $E \rightarrow \text{int}$
 $E \rightarrow (E)$

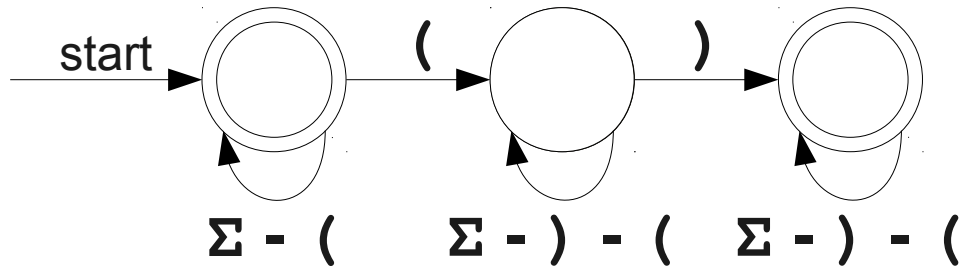

SCAN
 COMPLETE
 PREDICT

Items₁
 $S \rightarrow \cdot E @1$

Items₂

Items₃

$S \rightarrow E$
 $E \rightarrow E + E$
 $E \rightarrow \text{int}$
 $E \rightarrow (E)$

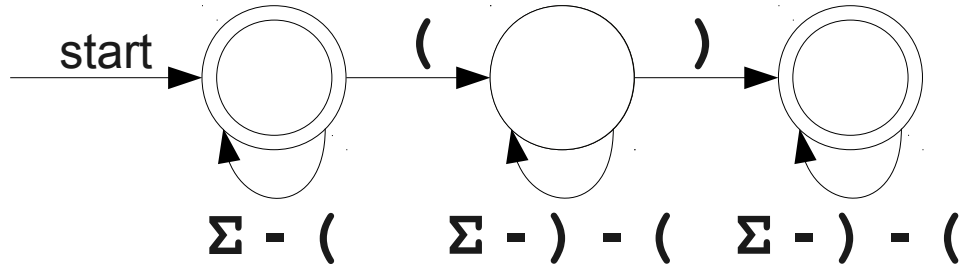

SCAN
 COMPLETE
 PREDICT

Items₁
 $S \rightarrow \cdot E @1$

Items₂

Items₃

$S \rightarrow E$
 $E \rightarrow E + E$
 $E \rightarrow \text{int}$
 $E \rightarrow (E)$

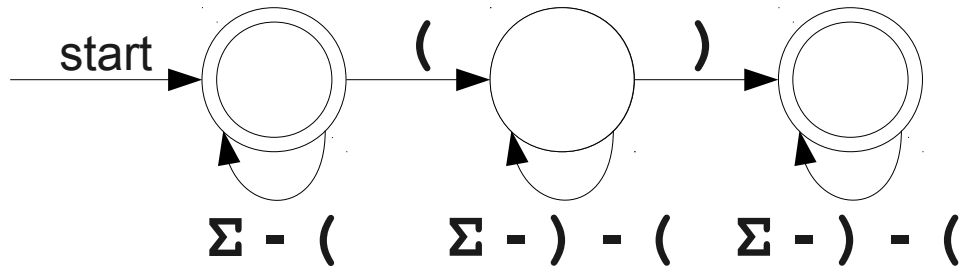

SCAN
 COMPLETE
 PREDICT

Items ₁
$S \rightarrow \cdot E @1$
$E \rightarrow \cdot E + E @1$
$E \rightarrow \cdot (E) @1$
$E \rightarrow \cdot \text{int} @1$

Items₂

Items₃

$S \rightarrow E$
 $E \rightarrow E + E$
 $E \rightarrow \text{int}$
 $E \rightarrow (E)$

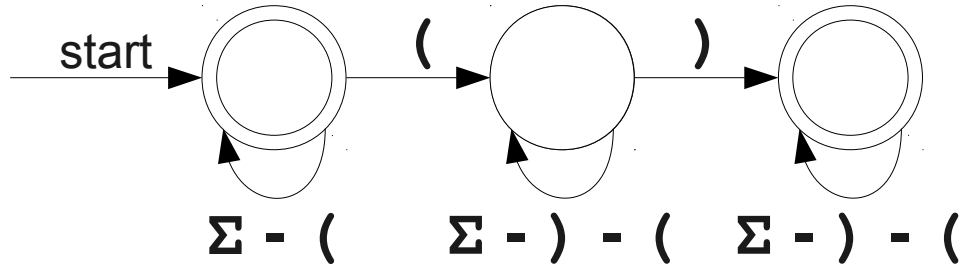

SCAN
 COMPLETE
 PREDICT

Items ₁
$S \rightarrow \cdot E @1$
$E \rightarrow \cdot E + E @1$
$E \rightarrow \cdot (E) @1$
$E \rightarrow \cdot \text{int} @1$

Items₂

Items₃

$S \rightarrow E$
 $E \rightarrow E + E$
 $E \rightarrow \text{int}$
 $E \rightarrow (E)$

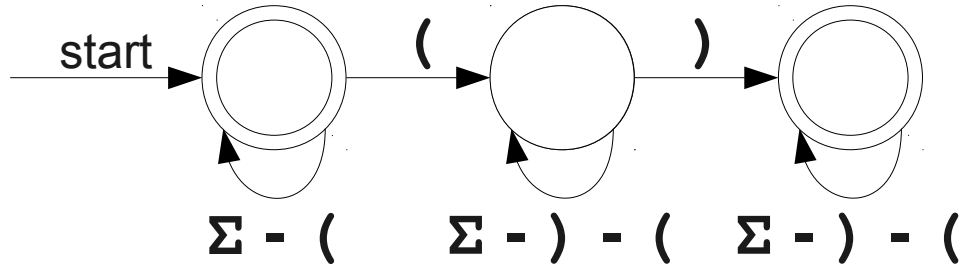

SCAN
 COMPLETE
 PREDICT

Items₁
 $S \rightarrow \cdot E @1$
 $E \rightarrow \cdot E + E @1$
 $E \rightarrow \cdot (E) @1$
 $E \rightarrow \cdot \text{int} @1$

Items₂
 $E \rightarrow (\cdot E) @1$

Items₃

$S \rightarrow E$
 $E \rightarrow E + E$
 $E \rightarrow \text{int}$
 $E \rightarrow (E)$

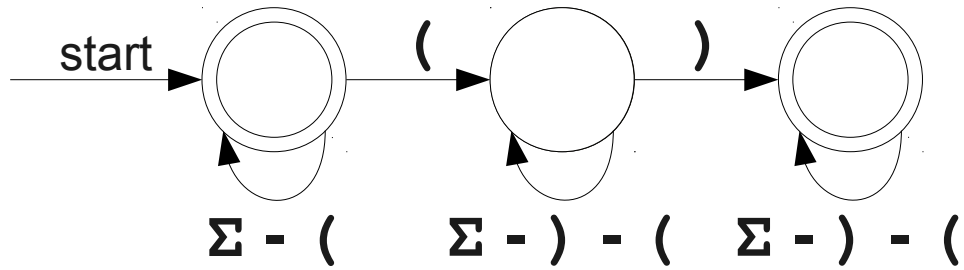

SCAN
 COMPLETE
 PREDICT

Items₁
 $S \rightarrow \cdot E @1$
 $E \rightarrow \cdot E + E @1$
 $E \rightarrow \cdot (E) @1$
 $E \rightarrow \cdot \text{int} @1$
 $E \rightarrow \text{int} \cdot @1$

Items₂
 $E \rightarrow (\cdot E) @1$

Items₃

$S \rightarrow E$
 $E \rightarrow E + E$
 $E \rightarrow \text{int}$
 $E \rightarrow (E)$

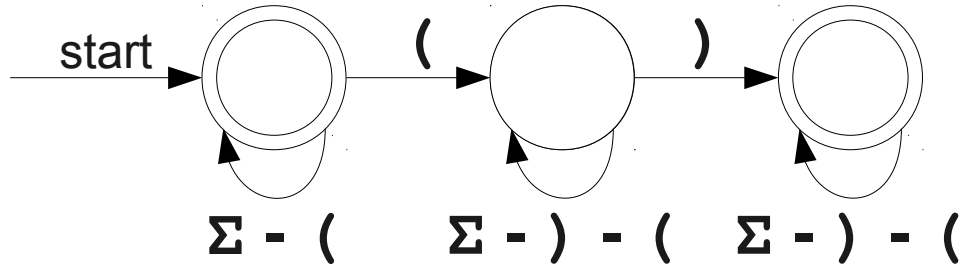

SCAN
 COMPLETE
 PREDICT

Items ₁
$S \rightarrow \cdot E @1$
$E \rightarrow \cdot E + E @1$
$E \rightarrow \cdot (E) @1$
$E \rightarrow \cdot \text{int} @1$
$E \rightarrow \text{int} \cdot @1$

Items ₂
$E \rightarrow (\cdot E) @1$

Items ₃

$S \rightarrow E$
 $E \rightarrow E + E$
 $E \rightarrow \text{int}$
 $E \rightarrow (E)$

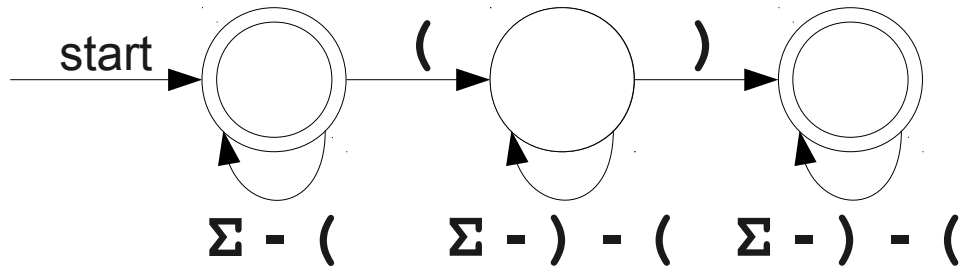

SCAN
 COMPLETE
 PREDICT

$E_{1-1} \rightarrow \text{int}_{1-1}$

Items ₁	Items ₂	Items ₃
S → · E @1	E → (· E) @1	
E → · E + E @1		
E → · (E) @1		
E → · int @1		
E → int · @1		

$S \rightarrow E$
 $E \rightarrow E + E$
 $E \rightarrow \text{int}$
 $E \rightarrow (E)$

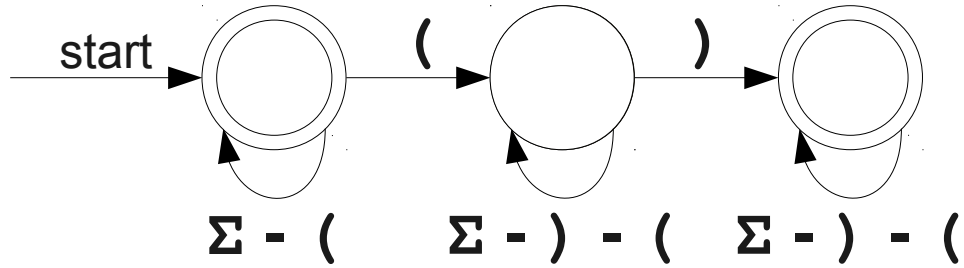

SCAN
 COMPLETE
 PREDICT

$E_{1-1} \rightarrow \text{int}_{1-1}$

Items ₁	Items ₂	Items ₃
$S \rightarrow \cdot E @1$	$E \rightarrow (\cdot E) @1$	
$E \rightarrow \cdot E + E @1$		
$E \rightarrow \cdot (E) @1$		
$E \rightarrow \cdot \text{int} @1$		
$E \rightarrow \text{int} \cdot @1$		
$S \rightarrow E \cdot @1$		
$E \rightarrow E \cdot + E @1$		

$S \rightarrow E$
 $E \rightarrow E + E$
 $E \rightarrow \text{int}$
 $E \rightarrow (E)$

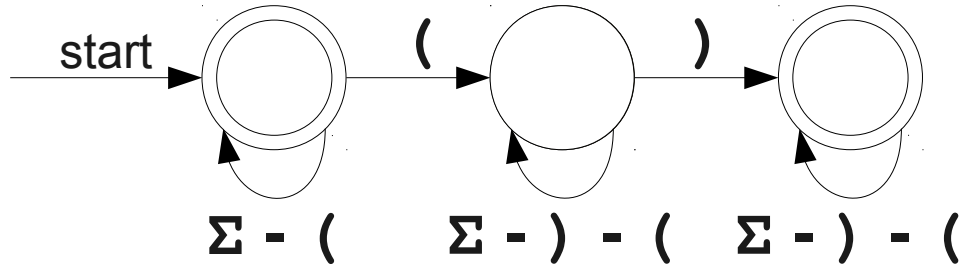

SCAN
 COMPLETE
 PREDICT

$E_{1-1} \rightarrow \text{int}_{1-1}$
 $S_{1-1} \rightarrow E_{1-1}$

Items ₁	Items ₂	Items ₃
$S \rightarrow \cdot E @1$	$E \rightarrow (\cdot E) @1$	
$E \rightarrow \cdot E + E @1$		
$E \rightarrow \cdot (E) @1$		
$E \rightarrow \cdot \text{int} @1$		
$E \rightarrow \text{int} \cdot @1$		
$S \rightarrow E \cdot @1$		
$E \rightarrow E \cdot + E @1$		

$S \rightarrow E$
 $E \rightarrow E + E$
 $E \rightarrow \text{int}$
 $E \rightarrow (E)$

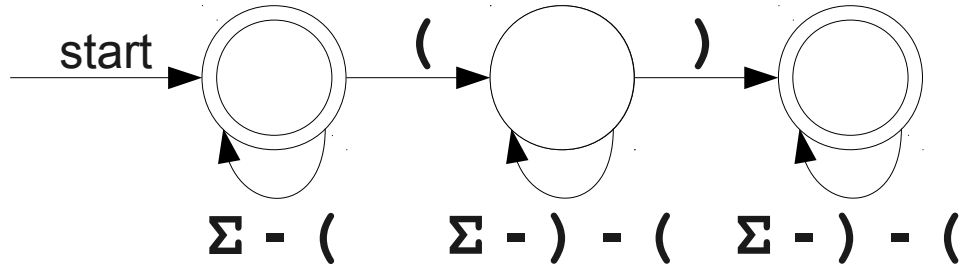

SCAN
 COMPLETE
 PREDICT

$E_{1-1} \rightarrow \text{int}_{1-1}$
 $S_{1-1} \rightarrow E_{1-1}$

Items ₁	Items ₂	Items ₃
$S \rightarrow \cdot E @1$	$E \rightarrow (\cdot E) @1$	
$E \rightarrow \cdot E + E @1$		
$E \rightarrow \cdot (E) @1$		
$E \rightarrow \cdot \text{int} @1$		
$E \rightarrow \text{int} \cdot @1$		
$S \rightarrow E \cdot @1$		
$E \rightarrow E \cdot + E @1$		

$S \rightarrow E$
 $E \rightarrow E + E$
 $E \rightarrow \text{int}$
 $E \rightarrow (E)$

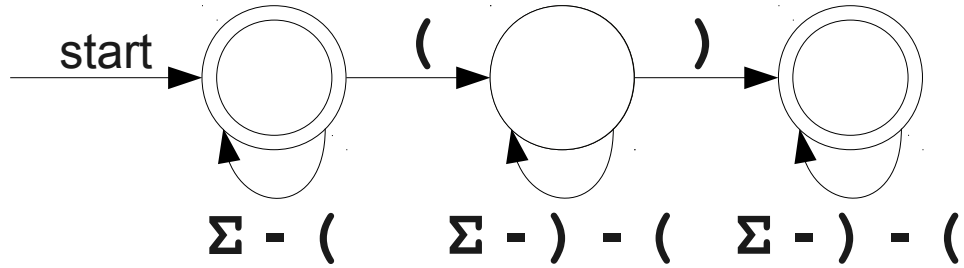

SCAN
 COMPLETE
 PREDICT

$E_{1-1} \rightarrow \text{int}_{1-1}$
 $S_{1-1} \rightarrow E_{1-1}$

Items ₁	Items ₂	Items ₃
$S \rightarrow \cdot E @1$	$E \rightarrow (\cdot E) @1$	
$E \rightarrow \cdot E + E @1$	$E \rightarrow \cdot E + E @2$	
$E \rightarrow \cdot (E) @1$	$E \rightarrow \cdot (E) @2$	
$E \rightarrow \cdot \text{int} @1$	$E \rightarrow \cdot \text{int} @2$	
$E \rightarrow \text{int} \cdot @1$		
$S \rightarrow E \cdot @1$		
$E \rightarrow E \cdot + E @1$		

$S \rightarrow E$
 $E \rightarrow E + E$
 $E \rightarrow \text{int}$
 $E \rightarrow (E)$

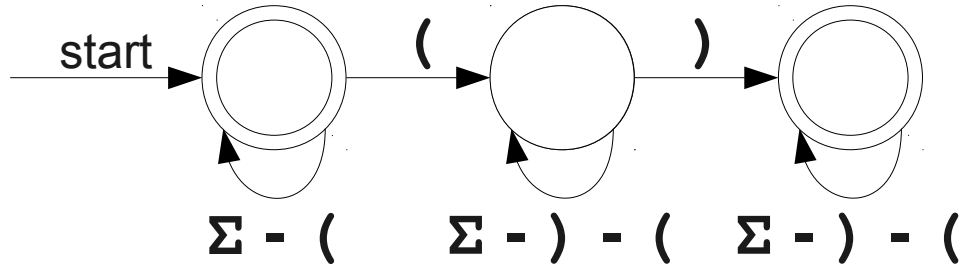

SCAN
 COMPLETE
 PREDICT

$E_{1-1} \rightarrow \text{int}_{1-1}$
 $S_{1-1} \rightarrow E_{1-1}$

Items ₁	Items ₂	Items ₃
$S \rightarrow \cdot E @1$	$E \rightarrow (\cdot E) @1$	
$E \rightarrow \cdot E + E @1$	$E \rightarrow \cdot E + E @2$	
$E \rightarrow \cdot (E) @1$	$E \rightarrow \cdot (E) @2$	
$E \rightarrow \cdot \text{int} @1$	$E \rightarrow \cdot \text{int} @2$	
$E \rightarrow \text{int} \cdot @1$		
$S \rightarrow E \cdot @1$		
$E \rightarrow E \cdot + E @1$		

$S \rightarrow E$
 $E \rightarrow E + E$
 $E \rightarrow \mathbf{int}$
 $E \rightarrow (E)$

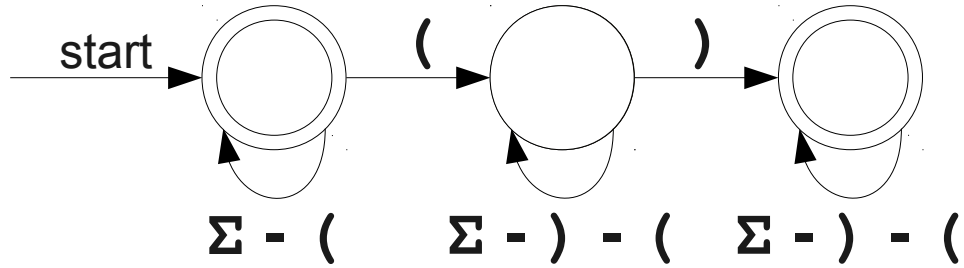

SCAN
 COMPLETE
 PREDICT

$E_{1-1} \rightarrow \mathbf{int}_{1-1}$
 $S_{1-1} \rightarrow E_{1-1}$

Items ₁	Items ₂	Items ₃
$S \rightarrow \cdot E @1$	$E \rightarrow (\cdot E) @1$	
$E \rightarrow \cdot E + E @1$	$E \rightarrow \cdot E + E @2$	
$E \rightarrow \cdot (E) @1$	$E \rightarrow \cdot (E) @2$	
$E \rightarrow \cdot \mathbf{int} @1$	$E \rightarrow \cdot \mathbf{int} @2$	
$E \rightarrow \mathbf{int} \cdot @1$		
$S \rightarrow E \cdot @1$		
$E \rightarrow E \cdot + E @1$		
$E \rightarrow E + \cdot E @1$		

$S \rightarrow E$
 $E \rightarrow E + E$
 $E \rightarrow \text{int}$
 $E \rightarrow (E)$

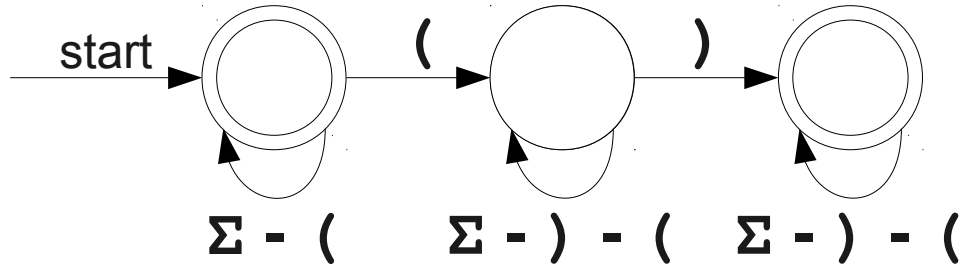

SCAN
COMPLETE
PREDICT

$E_{1-1} \rightarrow \text{int}_{1-1}$
 $S_{1-1} \rightarrow E_{1-1}$

Items ₁	Items ₂	Items ₃
$S \rightarrow \cdot E @1$	$E \rightarrow (\cdot E) @1$	
$E \rightarrow \cdot E + E @1$	$E \rightarrow \cdot E + E @2$	
$E \rightarrow \cdot (E) @1$	$E \rightarrow \cdot (E) @2$	
$E \rightarrow \cdot \text{int} @1$	$E \rightarrow \cdot \text{int} @2$	
$E \rightarrow \text{int} \cdot @1$	$E \rightarrow \text{int} \cdot @2$	
$S \rightarrow E \cdot @1$		
$E \rightarrow E \cdot + E @1$		
$E \rightarrow E + \cdot E @1$		

$S \rightarrow E$
 $E \rightarrow E + E$
 $E \rightarrow \text{int}$
 $E \rightarrow (E)$

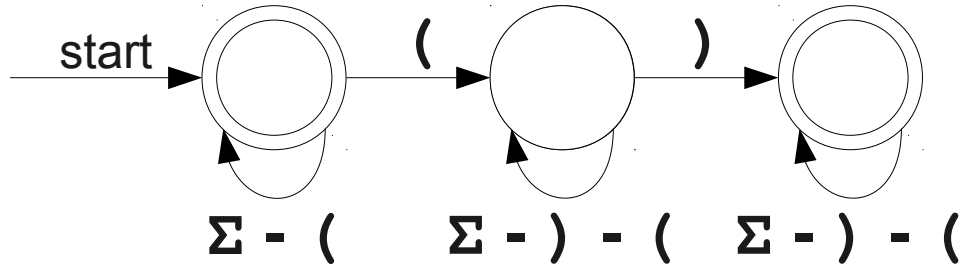

SCAN
 COMPLETE
 PREDICT

$E_{1-1} \rightarrow \text{int}_{1-1}$
 $S_{1-1} \rightarrow E_{1-1}$

Items ₁	Items ₂	Items ₃
$S \rightarrow \cdot E @1$	$E \rightarrow (\cdot E) @1$	
$E \rightarrow \cdot E + E @1$	$E \rightarrow \cdot E + E @2$	
$E \rightarrow \cdot (E) @1$	$E \rightarrow \cdot (E) @2$	
$E \rightarrow \cdot \text{int} @1$	$E \rightarrow \cdot \text{int} @2$	
$E \rightarrow \text{int} \cdot @1$	$E \rightarrow \text{int} \cdot @2$	
$S \rightarrow E \cdot @1$		
$E \rightarrow E \cdot + E @1$		
$E \rightarrow E + \cdot E @1$		

$S \rightarrow E$
 $E \rightarrow E + E$
 $E \rightarrow \text{int}$
 $E \rightarrow (E)$

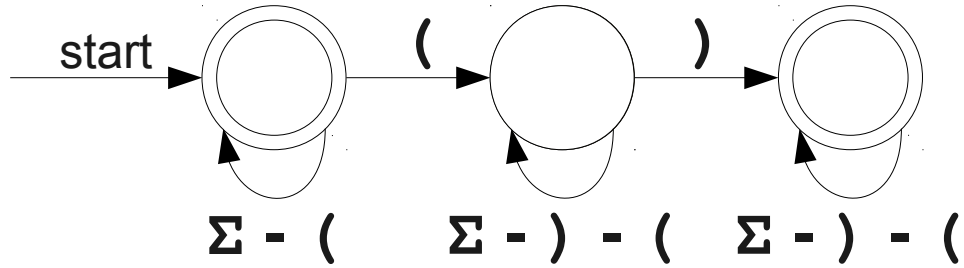

SCAN
 COMPLETE
 PREDICT

$E_{1-1} \rightarrow \text{int}_{1-1}$
 $S_{1-1} \rightarrow E_{1-1}$
 $E_{2-2} \rightarrow \text{int}_{2-2}$

Items ₁	Items ₂	Items ₃
$S \rightarrow \cdot E @1$	$E \rightarrow (\cdot E) @1$	
$E \rightarrow \cdot E + E @1$	$E \rightarrow \cdot E + E @2$	
$E \rightarrow \cdot (E) @1$	$E \rightarrow \cdot (E) @2$	
$E \rightarrow \cdot \text{int} @1$	$E \rightarrow \cdot \text{int} @2$	
$E \rightarrow \text{int} \cdot @1$	$E \rightarrow \text{int} \cdot @2$	
$S \rightarrow E \cdot @1$		
$E \rightarrow E \cdot + E @1$		
$E \rightarrow E + \cdot E @1$		

$S \rightarrow E$
 $E \rightarrow E + E$
 $E \rightarrow \text{int}$
 $E \rightarrow (E)$

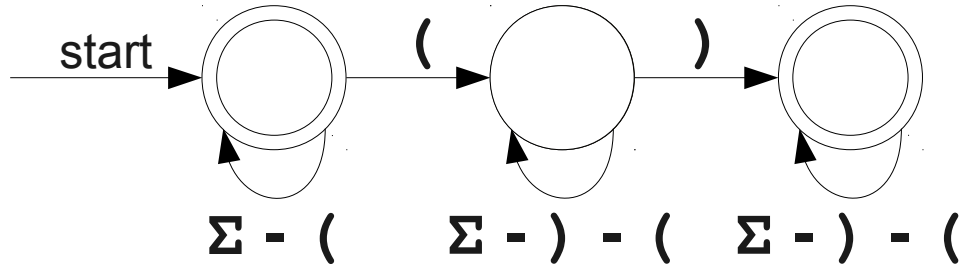

SCAN
 COMPLETE
 PREDICT

$E_{1-1} \rightarrow \text{int}_{1-1}$
 $S_{1-1} \rightarrow E_{1-1}$
 $E_{2-2} \rightarrow \text{int}_{2-2}$

Items ₁	Items ₂	Items ₃
$S \rightarrow \cdot E @1$	$E \rightarrow (\cdot E) @1$	
$E \rightarrow \cdot E + E @1$	$E \rightarrow \cdot E + E @2$	
$E \rightarrow \cdot (E) @1$	$E \rightarrow \cdot (E) @2$	
$E \rightarrow \cdot \text{int} @1$	$E \rightarrow \cdot \text{int} @2$	
$E \rightarrow \text{int} \cdot @1$	$E \rightarrow \text{int} \cdot @2$	
$S \rightarrow E \cdot @1$	$E \rightarrow (E \cdot) @1$	
$E \rightarrow E \cdot + E @1$	$E \rightarrow E \cdot + E @2$	
$E \rightarrow E + \cdot E @1$		

$S \rightarrow E$
 $E \rightarrow E + E$
 $E \rightarrow \text{int}$
 $E \rightarrow (E)$

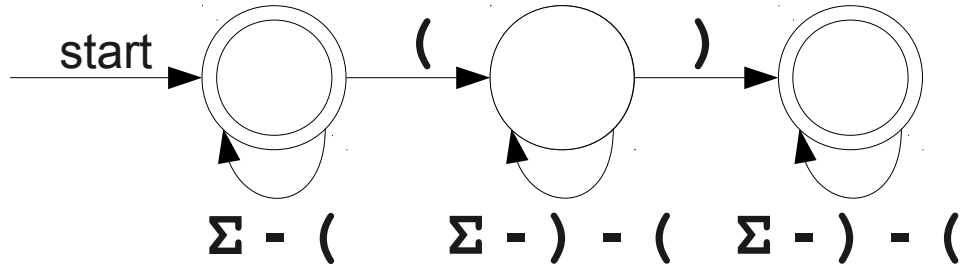

SCAN
 COMPLETE
 PREDICT

$E_{1-1} \rightarrow \text{int}_{1-1}$
 $S_{1-1} \rightarrow E_{1-1}$
 $E_{2-2} \rightarrow \text{int}_{2-2}$

Items ₁	Items ₂	Items ₃
$S \rightarrow \cdot E @1$	$E \rightarrow (\cdot E) @1$	
$E \rightarrow \cdot E + E @1$	$E \rightarrow \cdot E + E @2$	
$E \rightarrow \cdot (E) @1$	$E \rightarrow \cdot (E) @2$	
$E \rightarrow \cdot \text{int} @1$	$E \rightarrow \cdot \text{int} @2$	
$E \rightarrow \text{int} \cdot @1$	$E \rightarrow \text{int} \cdot @2$	
$S \rightarrow E \cdot @1$	$E \rightarrow (E \cdot) @1$	
$E \rightarrow E \cdot + E @1$	$E \rightarrow E \cdot + E @2$	
$E \rightarrow E + \cdot E @1$		
$E \rightarrow E + E \cdot @1$		

$S \rightarrow E$
 $E \rightarrow E + E$
 $E \rightarrow \text{int}$
 $E \rightarrow (E)$

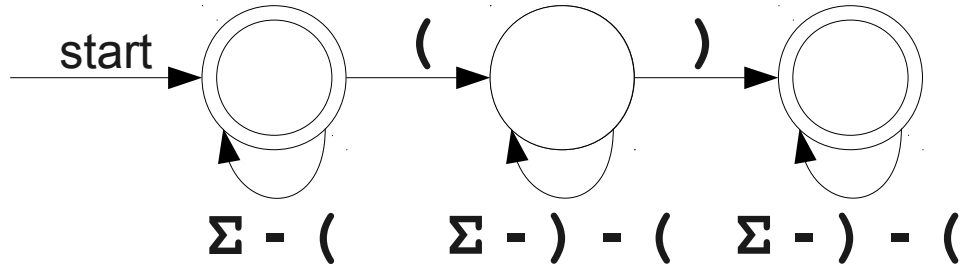

SCAN
 COMPLETE
 PREDICT

$E_{1-1} \rightarrow \text{int}_{1-1}$
 $S_{1-1} \rightarrow E_{1-1}$
 $E_{2-2} \rightarrow \text{int}_{2-2}$
 $E_{1-1} \rightarrow E_{1-1} +_{1-1} E_{1-1}$

Items ₁	Items ₂	Items ₃
$S \rightarrow \cdot E @1$	$E \rightarrow (\cdot E) @1$	
$E \rightarrow \cdot E + E @1$	$E \rightarrow \cdot E + E @2$	
$E \rightarrow \cdot (E) @1$	$E \rightarrow \cdot (E) @2$	
$E \rightarrow \cdot \text{int} @1$	$E \rightarrow \cdot \text{int} @2$	
$E \rightarrow \text{int} \cdot @1$	$E \rightarrow \text{int} \cdot @2$	
$S \rightarrow E \cdot @1$	$E \rightarrow (E \cdot) @1$	
$E \rightarrow E \cdot + E @1$	$E \rightarrow E \cdot + E @2$	
$E \rightarrow E + \cdot E @1$		
$E \rightarrow E + E \cdot @1$		

$S \rightarrow E$
 $E \rightarrow E + E$
 $E \rightarrow \text{int}$
 $E \rightarrow (E)$

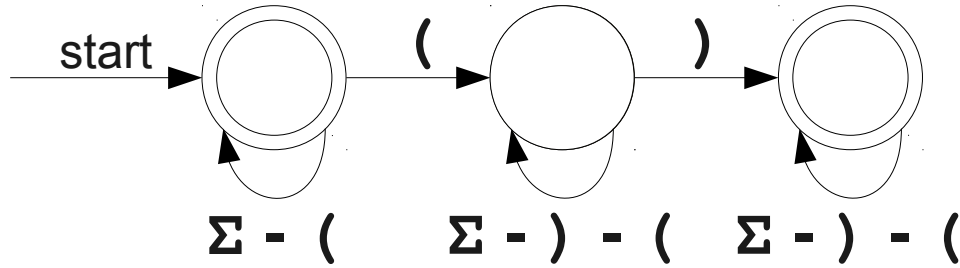

SCAN
 COMPLETE
 PREDICT

$E_{1-1} \rightarrow \text{int}_{1-1}$
 $S_{1-1} \rightarrow E_{1-1}$
 $E_{2-2} \rightarrow \text{int}_{2-2}$
 $E_{1-1} \rightarrow E_{1-1} +_{1-1} E_{1-1}$

Items ₁	Items ₂	Items ₃
$S \rightarrow \cdot E @1$	$E \rightarrow (\cdot E) @1$	
$E \rightarrow \cdot E + E @1$	$E \rightarrow \cdot E + E @2$	
$E \rightarrow \cdot (E) @1$	$E \rightarrow \cdot (E) @2$	
$E \rightarrow \cdot \text{int} @1$	$E \rightarrow \cdot \text{int} @2$	
$E \rightarrow \text{int} \cdot @1$	$E \rightarrow \text{int} \cdot @2$	
$S \rightarrow E \cdot @1$	$E \rightarrow (E \cdot) @1$	
$E \rightarrow E \cdot + E @1$	$E \rightarrow E \cdot + E @2$	
$E \rightarrow E + \cdot E @1$		
$E \rightarrow E + E \cdot @1$		

$S \rightarrow E$
 $E \rightarrow E + E$
 $E \rightarrow \text{int}$
 $E \rightarrow (E)$

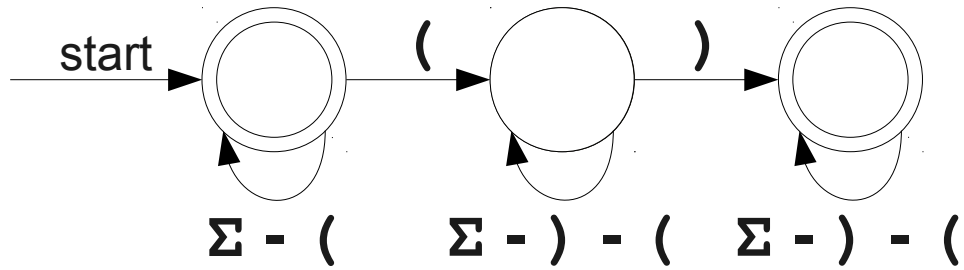

SCAN
COMPLETE
PREDICT

$E_{1-1} \rightarrow \text{int}_{1-1}$
 $S_{1-1} \rightarrow E_{1-1}$
 $E_{2-2} \rightarrow \text{int}_{2-2}$
 $E_{1-1} \rightarrow E_{1-1} +_{1-1} E_{1-1}$

Items ₁	Items ₂	Items ₃
$S \rightarrow \cdot E @1$	$E \rightarrow (\cdot E) @1$	
$E \rightarrow \cdot E + E @1$	$E \rightarrow \cdot E + E @2$	
$E \rightarrow \cdot (E) @1$	$E \rightarrow \cdot (E) @2$	
$E \rightarrow \cdot \text{int} @1$	$E \rightarrow \cdot \text{int} @2$	
$E \rightarrow \text{int} \cdot @1$	$E \rightarrow \text{int} \cdot @2$	
$S \rightarrow E \cdot @1$	$E \rightarrow (E \cdot) @1$	
$E \rightarrow E \cdot + E @1$	$E \rightarrow E \cdot + E @2$	
$E \rightarrow E + \cdot E @1$		
$E \rightarrow E + E \cdot @1$		

$S \rightarrow E$
 $E \rightarrow E + E$
 $E \rightarrow \text{int}$
 $E \rightarrow (E)$

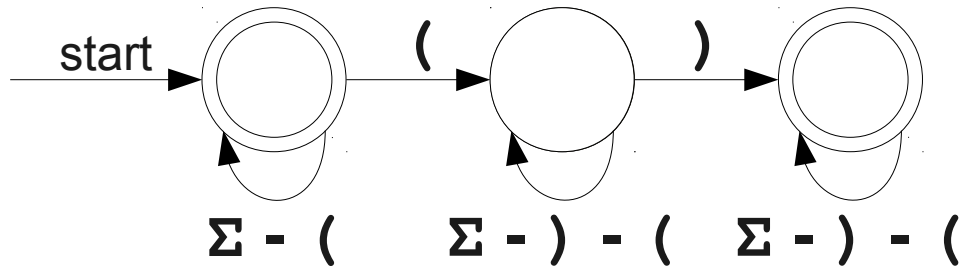

SCAN
COMPLETE
PREDICT

$E_{1-1} \rightarrow \text{int}_{1-1}$
 $S_{1-1} \rightarrow E_{1-1}$
 $E_{2-2} \rightarrow \text{int}_{2-2}$
 $E_{1-1} \rightarrow E_{1-1} +_{1-1} E_{1-1}$

Items ₁	Items ₂	Items ₃
$S \rightarrow \cdot E @1$	$E \rightarrow (\cdot E) @1$	$E \rightarrow (E) \cdot @1$
$E \rightarrow \cdot E + E @1$	$E \rightarrow \cdot E + E @2$	
$E \rightarrow \cdot (E) @1$	$E \rightarrow \cdot (E) @2$	
$E \rightarrow \cdot \text{int} @1$	$E \rightarrow \cdot \text{int} @2$	
$E \rightarrow \text{int} \cdot @1$	$E \rightarrow \text{int} \cdot @2$	
$S \rightarrow E \cdot @1$	$E \rightarrow (E \cdot) @1$	
$E \rightarrow E \cdot + E @1$	$E \rightarrow E \cdot + E @2$	
$E \rightarrow E + \cdot E @1$		
$E \rightarrow E + E \cdot @1$		

$S \rightarrow E$
 $E \rightarrow E + E$
 $E \rightarrow \text{int}$
 $E \rightarrow (E)$

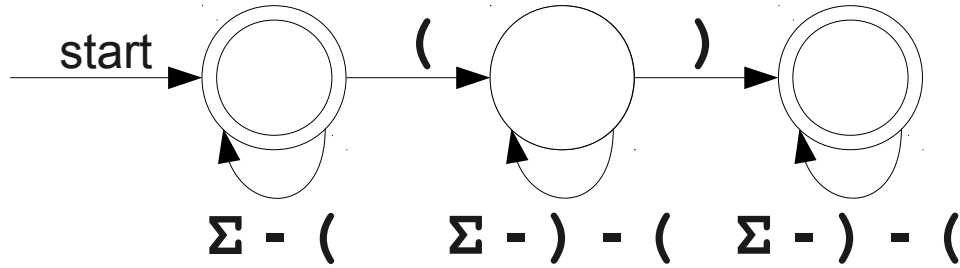

SCAN
COMPLETE
PREDICT

$E_{1-1} \rightarrow \text{int}_{1-1}$
 $S_{1-1} \rightarrow E_{1-1}$
 $E_{2-2} \rightarrow \text{int}_{2-2}$
 $E_{1-1} \rightarrow E_{1-1} +_{1-1} E_{1-1}$

Items ₁
$S \rightarrow \cdot E @1$
$E \rightarrow \cdot E + E @1$
$E \rightarrow \cdot (E) @1$
$E \rightarrow \cdot \text{int} @1$
$E \rightarrow \text{int} \cdot @1$
$S \rightarrow E \cdot @1$
$E \rightarrow E \cdot + E @1$
$E \rightarrow E + \cdot E @1$
$E \rightarrow E + E \cdot @1$

Items ₂
$E \rightarrow (\cdot E) @1$
$E \rightarrow \cdot E + E @2$
$E \rightarrow \cdot (E) @2$
$E \rightarrow \cdot \text{int} @2$
$E \rightarrow \text{int} \cdot @2$
$E \rightarrow (E \cdot) @1$
$E \rightarrow E \cdot + E @2$
$E \rightarrow E + \cdot E @2$

Items ₃
$E \rightarrow (E) \cdot @1$

$S \rightarrow E$
 $E \rightarrow E + E$
 $E \rightarrow \text{int}$
 $E \rightarrow (E)$

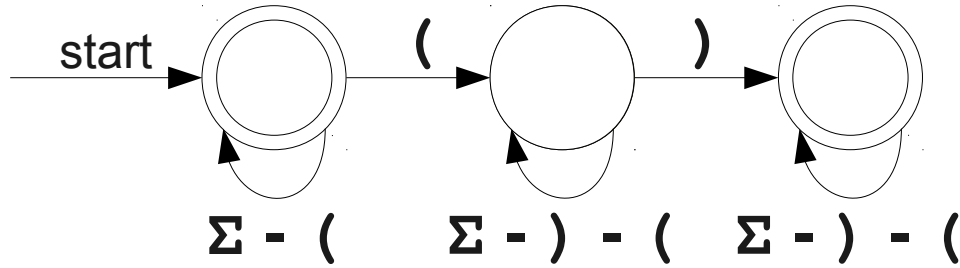

SCAN
 COMPLETE
 PREDICT

$E_{1-1} \rightarrow \text{int}_{1-1}$
 $S_{1-1} \rightarrow E_{1-1}$
 $E_{2-2} \rightarrow \text{int}_{2-2}$
 $E_{1-1} \rightarrow E_{1-1} +_{1-1} E_{1-1}$

Items ₁	Items ₂	Items ₃
$S \rightarrow \cdot E @1$	$E \rightarrow (\cdot E) @1$	$E \rightarrow (E) \cdot @1$
$E \rightarrow \cdot E + E @1$	$E \rightarrow \cdot E + E @2$	
$E \rightarrow \cdot (E) @1$	$E \rightarrow \cdot (E) @2$	
$E \rightarrow \cdot \text{int} @1$	$E \rightarrow \cdot \text{int} @2$	
$E \rightarrow \text{int} \cdot @1$	$E \rightarrow \text{int} \cdot @2$	
$S \rightarrow E \cdot @1$	$E \rightarrow (E \cdot) @1$	
$E \rightarrow E \cdot + E @1$	$E \rightarrow E \cdot + E @2$	
$E \rightarrow E + \cdot E @1$	$E \rightarrow E + \cdot E @2$	
$E \rightarrow E + E \cdot @1$		

$S \rightarrow E$
 $E \rightarrow E + E$
 $E \rightarrow \text{int}$
 $E \rightarrow (E)$

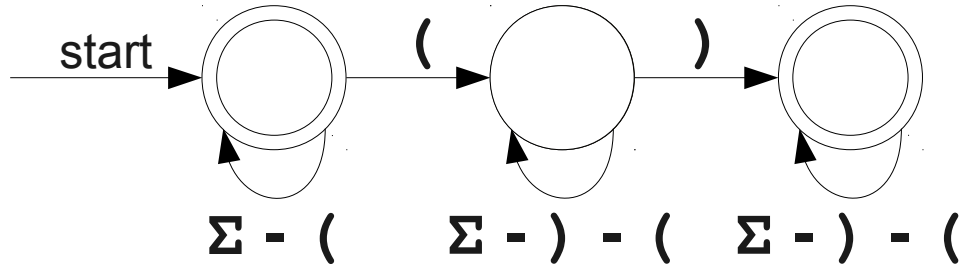

SCAN
 COMPLETE
 PREDICT

$E_{1-1} \rightarrow \text{int}_{1-1}$
 $S_{1-1} \rightarrow E_{1-1}$
 $E_{2-2} \rightarrow \text{int}_{2-2}$
 $E_{1-1} \rightarrow E_{1-1} +_{1-1} E_{1-1}$
 $E_{1-3} \rightarrow (_{1-2} E_{2-2})_{2-3}$

Items ₁	Items ₂	Items ₃
$S \rightarrow \cdot E @1$	$E \rightarrow (\cdot E) @1$	$E \rightarrow (E) \cdot @1$
$E \rightarrow \cdot E + E @1$	$E \rightarrow \cdot E + E @2$	
$E \rightarrow \cdot (E) @1$	$E \rightarrow \cdot (E) @2$	
$E \rightarrow \cdot \text{int} @1$	$E \rightarrow \cdot \text{int} @2$	
$E \rightarrow \text{int} \cdot @1$	$E \rightarrow \text{int} \cdot @2$	
$S \rightarrow E \cdot @1$	$E \rightarrow (E \cdot) @1$	
$E \rightarrow E \cdot + E @1$	$E \rightarrow E \cdot + E @2$	
$E \rightarrow E + \cdot E @1$	$E \rightarrow E + \cdot E @2$	
$E \rightarrow E + E \cdot @1$		

$S \rightarrow E$
 $E \rightarrow E + E$
 $E \rightarrow \mathbf{int}$
 $E \rightarrow (E)$

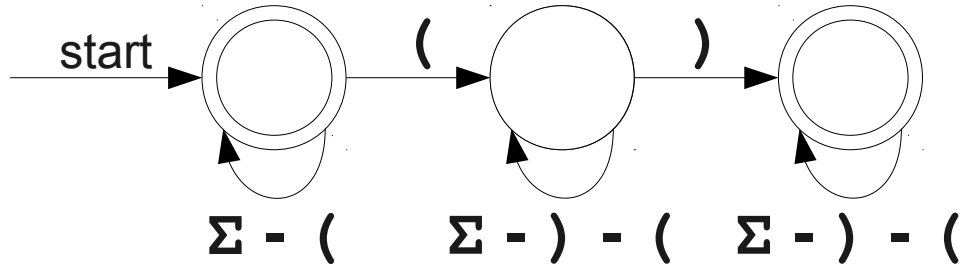

SCAN
 COMPLETE
 PREDICT

$E_{1-1} \rightarrow \mathbf{int}_{1-1}$
 $S_{1-1} \rightarrow E_{1-1}$
 $E_{2-2} \rightarrow \mathbf{int}_{2-2}$
 $E_{1-1} \rightarrow E_{1-1} +_{1-1} E_{1-1}$
 $E_{1-3} \rightarrow (_{1-2} E_{2-2})_{2-3}$

Items ₁	Items ₂	Items ₃
$S \rightarrow \cdot E @1$	$E \rightarrow (\cdot E) @1$	$E \rightarrow (E) \cdot @1$
$E \rightarrow \cdot E + E @1$	$E \rightarrow \cdot E + E @2$	$S \rightarrow E \cdot @1$
$E \rightarrow \cdot (E) @1$	$E \rightarrow \cdot (E) @2$	$E \rightarrow E \cdot + E @1$
$E \rightarrow \cdot \mathbf{int} @1$	$E \rightarrow \cdot \mathbf{int} @2$	$E \rightarrow E + E \cdot @1$
$E \rightarrow \mathbf{int} \cdot @1$	$E \rightarrow \mathbf{int} \cdot @2$	
$S \rightarrow E \cdot @1$	$E \rightarrow (E \cdot) @1$	
$E \rightarrow E \cdot + E @1$	$E \rightarrow E \cdot + E @2$	
$E \rightarrow E + \cdot E @1$	$E \rightarrow E + \cdot E @2$	
$E \rightarrow E + E \cdot @1$		

$S \rightarrow E$
 $E \rightarrow E + E$
 $E \rightarrow \text{int}$
 $E \rightarrow (E)$

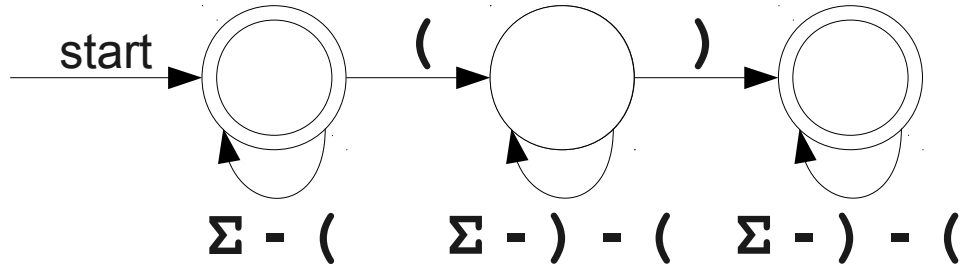

SCAN
 COMPLETE
 PREDICT

$E_{1-1} \rightarrow \text{int}_{1-1}$
 $S_{1-1} \rightarrow E_{1-1}$
 $E_{2-2} \rightarrow \text{int}_{2-2}$
 $E_{1-1} \rightarrow E_{1-1} +_{1-1} E_{1-1}$
 $E_{1-3} \rightarrow (_{1-2} E_{2-2})_{2-3}$
 $S_{1-3} \rightarrow E_{1-3}$

Items ₁	Items ₂	Items ₃
$S \rightarrow \cdot E @1$	$E \rightarrow (\cdot E) @1$	$E \rightarrow (E) \cdot @1$
$E \rightarrow \cdot E + E @1$	$E \rightarrow \cdot E + E @2$	$S \rightarrow E \cdot @1$
$E \rightarrow \cdot (E) @1$	$E \rightarrow \cdot (E) @2$	$E \rightarrow E \cdot + E @1$
$E \rightarrow \cdot \text{int} @1$	$E \rightarrow \cdot \text{int} @2$	$E \rightarrow E + E \cdot @1$
$E \rightarrow \text{int} \cdot @1$	$E \rightarrow \text{int} \cdot @2$	
$S \rightarrow E \cdot @1$	$E \rightarrow (E \cdot) @1$	
$E \rightarrow E \cdot + E @1$	$E \rightarrow E \cdot + E @2$	
$E \rightarrow E + \cdot E @1$	$E \rightarrow E + \cdot E @2$	
$E \rightarrow E + E \cdot @1$		

$S \rightarrow E$
 $E \rightarrow E + E$
 $E \rightarrow \text{int}$
 $E \rightarrow (E)$

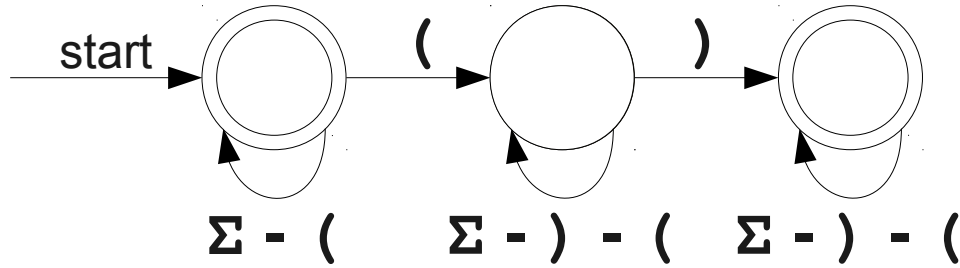

SCAN
 COMPLETE
 PREDICT

$E_{1-1} \rightarrow \text{int}_{1-1}$
 $S_{1-1} \rightarrow E_{1-1}$
 $E_{2-2} \rightarrow \text{int}_{2-2}$
 $E_{1-1} \rightarrow E_{1-1} +_{1-1} E_{1-1}$
 $E_{1-3} \rightarrow (_{1-2} E_{2-2})_{2-3}$
 $S_{1-3} \rightarrow E_{1-3}$
 $E_{1-3} \rightarrow E_{1-1} +_{1-1} E_{1-3}$

Items ₁
$S \rightarrow \cdot E @1$
$E \rightarrow \cdot E + E @1$
$E \rightarrow \cdot (E) @1$
$E \rightarrow \cdot \text{int} @1$
$E \rightarrow \text{int} \cdot @1$
$S \rightarrow E \cdot @1$
$E \rightarrow E \cdot + E @1$
$E \rightarrow E + \cdot E @1$
$E \rightarrow E + E \cdot @1$

Items ₂
$E \rightarrow (\cdot E) @1$
$E \rightarrow \cdot E + E @2$
$E \rightarrow \cdot (E) @2$
$E \rightarrow \cdot \text{int} @2$
$E \rightarrow \text{int} \cdot @2$
$E \rightarrow (E \cdot) @1$
$E \rightarrow E \cdot + E @2$
$E \rightarrow E + \cdot E @2$

Items ₃
$E \rightarrow (E) \cdot @1$
$S \rightarrow E \cdot @1$
$E \rightarrow E \cdot + E @1$
$E \rightarrow E + E \cdot @1$

$S \rightarrow E$
 $E \rightarrow E + E$
 $E \rightarrow \text{int}$
 $E \rightarrow (E)$

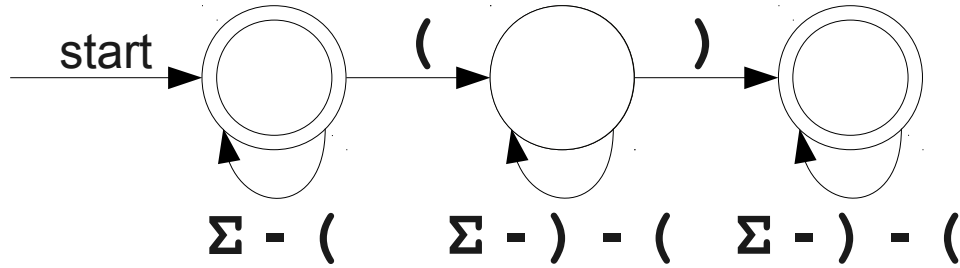

SCAN
 COMPLETE
 PREDICT

$E_{1-1} \rightarrow \text{int}_{1-1}$
 $S_{1-1} \rightarrow E_{1-1}$
 $E_{2-2} \rightarrow \text{int}_{2-2}$
 $E_{1-1} \rightarrow E_{1-1} +_{1-1} E_{1-1}$
 $E_{1-3} \rightarrow (_{1-2} E_{2-2})_{2-3}$
 $S_{1-3} \rightarrow E_{1-3}$
 $E_{1-3} \rightarrow E_{1-1} +_{1-1} E_{1-3}$

Items ₁
$S \rightarrow \cdot E @1$
$E \rightarrow \cdot E + E @1$
$E \rightarrow \cdot (E) @1$
$E \rightarrow \cdot \text{int} @1$
$E \rightarrow \text{int} \cdot @1$
$S \rightarrow E \cdot @1$
$E \rightarrow E \cdot + E @1$
$E \rightarrow E + \cdot E @1$
$E \rightarrow E + E \cdot @1$

Items ₂
$E \rightarrow (\cdot E) @1$
$E \rightarrow \cdot E + E @2$
$E \rightarrow \cdot (E) @2$
$E \rightarrow \cdot \text{int} @2$
$E \rightarrow \text{int} \cdot @2$
$E \rightarrow (E \cdot) @1$
$E \rightarrow E \cdot + E @2$
$E \rightarrow E + \cdot E @2$
$E \rightarrow E + E \cdot @2$

Items ₃
$E \rightarrow (E) \cdot @1$
$S \rightarrow E \cdot @1$
$E \rightarrow E \cdot + E @1$
$E \rightarrow E + E \cdot @1$

$S \rightarrow E$
 $E \rightarrow E + E$
 $E \rightarrow \text{int}$
 $E \rightarrow (E)$

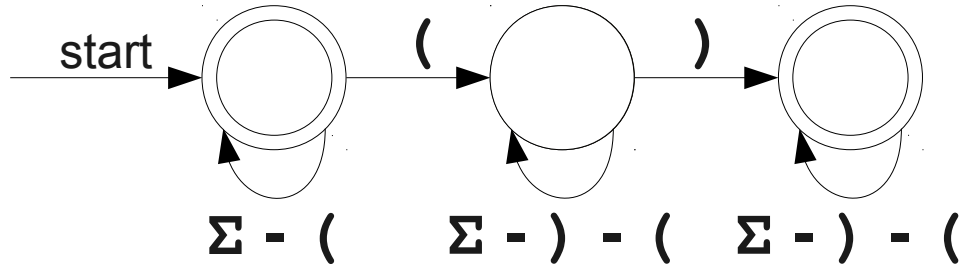

SCAN
 COMPLETE
 PREDICT

$E_{1-1} \rightarrow \text{int}_{1-1}$
 $S_{1-1} \rightarrow E_{1-1}$
 $E_{2-2} \rightarrow \text{int}_{2-2}$
 $E_{1-1} \rightarrow E_{1-1} +_{1-1} E_{1-1}$
 $E_{1-3} \rightarrow (_{1-2} E_{2-2})_{2-3}$
 $S_{1-3} \rightarrow E_{1-3}$
 $E_{1-3} \rightarrow E_{1-1} +_{1-1} E_{1-3}$
 $E_{2-2} \rightarrow E_{2-2} +_{2-2} E_{2-2}$

Items ₁
$S \rightarrow \cdot E @1$
$E \rightarrow \cdot E + E @1$
$E \rightarrow \cdot (E) @1$
$E \rightarrow \cdot \text{int} @1$
$E \rightarrow \text{int} \cdot @1$
$S \rightarrow E \cdot @1$
$E \rightarrow E \cdot + E @1$
$E \rightarrow E + \cdot E @1$
$E \rightarrow E + E \cdot @1$

Items ₂
$E \rightarrow (\cdot E) @1$
$E \rightarrow \cdot E + E @2$
$E \rightarrow \cdot (E) @2$
$E \rightarrow \cdot \text{int} @2$
$E \rightarrow \text{int} \cdot @2$
$E \rightarrow (E \cdot) @1$
$E \rightarrow E \cdot + E @2$
$E \rightarrow E + \cdot E @2$
$E \rightarrow E + E \cdot @2$

Items ₃
$E \rightarrow (E) \cdot @1$
$S \rightarrow E \cdot @1$
$E \rightarrow E \cdot + E @1$
$E \rightarrow E + E \cdot @1$

$S \rightarrow E$
 $E \rightarrow E + E$
 $E \rightarrow \text{int}$
 $E \rightarrow (E)$

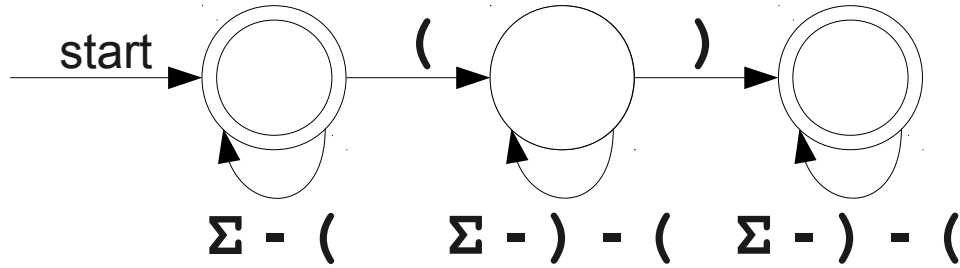

SCAN
 COMPLETE
 PREDICT

$E_{1-1} \rightarrow \text{int}_{1-1}$
 $S_{1-1} \rightarrow E_{1-1}$
 $E_{2-2} \rightarrow \text{int}_{2-2}$
 $E_{1-1} \rightarrow E_{1-1} +_{1-1} E_{1-1}$
 $E_{1-3} \rightarrow (_{1-2} E_{2-2})_{2-3}$
 $S_{1-3} \rightarrow E_{1-3}$
 $E_{1-3} \rightarrow E_{1-1} +_{1-1} E_{1-3}$
 $E_{2-2} \rightarrow E_{2-2} +_{2-2} E_{2-2}$

Items ₁
$S \rightarrow \cdot E @1$
$E \rightarrow \cdot E + E @1$
$E \rightarrow \cdot (E) @1$
$E \rightarrow \cdot \text{int} @1$
$E \rightarrow \text{int} \cdot @1$
$S \rightarrow E \cdot @1$
$E \rightarrow E \cdot + E @1$
$E \rightarrow E + \cdot E @1$
$E \rightarrow E + E \cdot @1$

Items ₂
$E \rightarrow (\cdot E) @1$
$E \rightarrow \cdot E + E @2$
$E \rightarrow \cdot (E) @2$
$E \rightarrow \cdot \text{int} @2$
$E \rightarrow \text{int} \cdot @2$
$E \rightarrow (E \cdot) @1$
$E \rightarrow E \cdot + E @2$
$E \rightarrow E + \cdot E @2$
$E \rightarrow E + E \cdot @2$

Items ₃
$E \rightarrow (E) \cdot @1$
$S \rightarrow E \cdot @1$
$E \rightarrow E \cdot + E @1$
$E \rightarrow E + E \cdot @1$

$S \rightarrow E$
 $E \rightarrow E + E$
 $E \rightarrow \mathbf{int}$
 $E \rightarrow (E)$

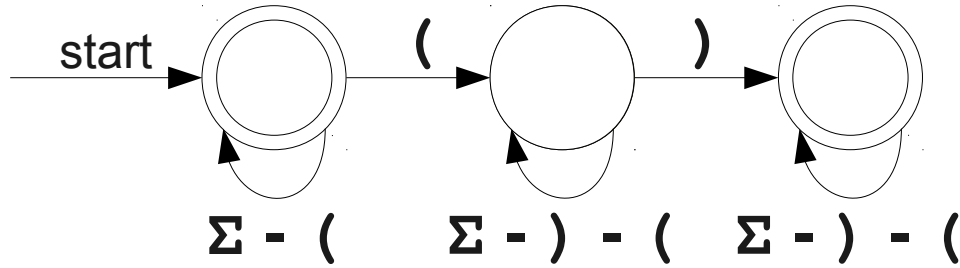

SCAN
COMPLETE
PREDICT

$E_{1-1} \rightarrow \mathbf{int}_{1-1}$
 $S_{1-1} \rightarrow E_{1-1}$
 $E_{2-2} \rightarrow \mathbf{int}_{2-2}$
 $E_{1-1} \rightarrow E_{1-1} +_{1-1} E_{1-1}$
 $E_{1-3} \rightarrow (_{1-2} E_{2-2})_{2-3}$
 $S_{1-3} \rightarrow E_{1-3}$
 $E_{1-3} \rightarrow E_{1-1} +_{1-1} E_{1-3}$
 $E_{2-2} \rightarrow E_{2-2} +_{2-2} E_{2-2}$

Items ₁
$S \rightarrow \cdot E @1$
$E \rightarrow \cdot E + E @1$
$E \rightarrow \cdot (E) @1$
$E \rightarrow \cdot \mathbf{int} @1$
$E \rightarrow \mathbf{int} \cdot @1$
$S \rightarrow E \cdot @1$
$E \rightarrow E \cdot + E @1$
$E \rightarrow E + \cdot E @1$
$E \rightarrow E + E \cdot @1$

Items ₂
$E \rightarrow (\cdot E) @1$
$E \rightarrow \cdot E + E @2$
$E \rightarrow \cdot (E) @2$
$E \rightarrow \cdot \mathbf{int} @2$
$E \rightarrow \mathbf{int} \cdot @2$
$E \rightarrow (E \cdot) @1$
$E \rightarrow E \cdot + E @2$
$E \rightarrow E + \cdot E @2$
$E \rightarrow E + E \cdot @2$

Items ₃
$E \rightarrow (E) \cdot @1$
$S \rightarrow E \cdot @1$
$E \rightarrow E \cdot + E @1$
$E \rightarrow E + E \cdot @1$

$S \rightarrow E$
 $E \rightarrow E + E$
 $E \rightarrow \text{int}$
 $E \rightarrow (E)$

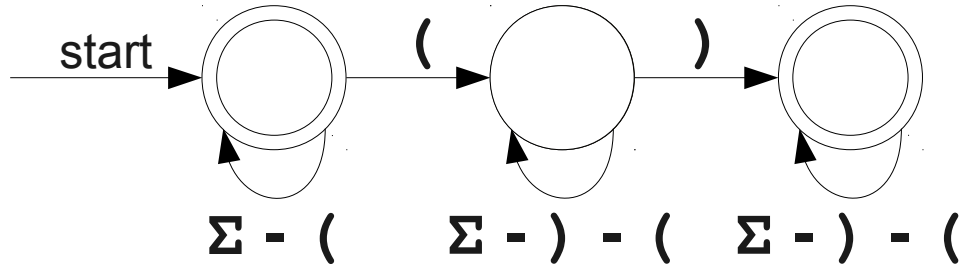

SCAN
 COMPLETE
 PREDICT

$E_{1-1} \rightarrow \text{int}_{1-1}$
 $S_{1-1} \rightarrow E_{1-1}$
 $E_{2-2} \rightarrow \text{int}_{2-2}$
 $E_{1-1} \rightarrow E_{1-1} +_{1-1} E_{1-1}$
 $E_{1-3} \rightarrow (_{1-2} E_{2-2})_{2-3}$
 $S_{1-3} \rightarrow E_{1-3}$
 $E_{1-3} \rightarrow E_{1-1} +_{1-1} E_{1-3}$
 $E_{2-2} \rightarrow E_{2-2} +_{2-2} E_{2-2}$

Items ₁	Items ₂	Items ₃
$S \rightarrow \cdot E @1$	$E \rightarrow (\cdot E) @1$	$E \rightarrow (E) \cdot @1$
$E \rightarrow \cdot E + E @1$	$E \rightarrow \cdot E + E @2$	$S \rightarrow E \cdot @1$
$E \rightarrow \cdot (E) @1$	$E \rightarrow \cdot (E) @2$	$E \rightarrow E \cdot + E @1$
$E \rightarrow \cdot \text{int} @1$	$E \rightarrow \cdot \text{int} @2$	$E \rightarrow E + E \cdot @1$
$E \rightarrow \text{int} \cdot @1$	$E \rightarrow \text{int} \cdot @2$	$E \rightarrow E + \cdot E @1$
$S \rightarrow E \cdot @1$	$E \rightarrow (E \cdot) @1$	
$E \rightarrow E \cdot + E @1$	$E \rightarrow E \cdot + E @2$	
$E \rightarrow E + \cdot E @1$	$E \rightarrow E + \cdot E @2$	
$E \rightarrow E + E \cdot @1$	$E \rightarrow E + E \cdot @2$	

$S \rightarrow E$
 $E \rightarrow E + E$
 $E \rightarrow \text{int}$
 $E \rightarrow (E)$

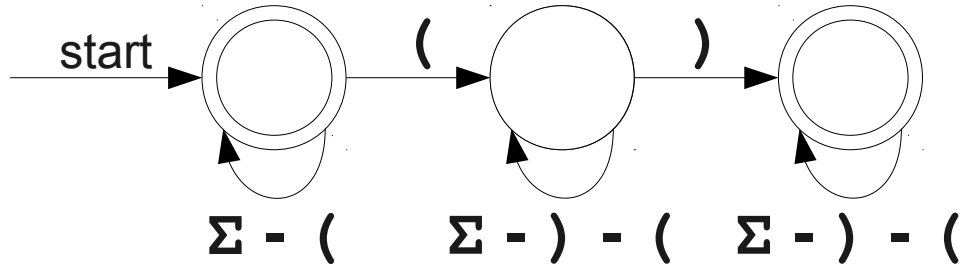

SCAN
 COMPLETE
 PREDICT

$E_{1-1} \rightarrow \text{int}_{1-1}$
 $S_{1-1} \rightarrow E_{1-1}$
 $E_{2-2} \rightarrow \text{int}_{2-2}$
 $E_{1-1} \rightarrow E_{1-1} +_{1-1} E_{1-1}$
 $E_{1-3} \rightarrow (_{1-2} E_{2-2})_{2-3}$
 $S_{1-3} \rightarrow E_{1-3}$
 $E_{1-3} \rightarrow E_{1-1} +_{1-1} E_{1-3}$
 $E_{2-2} \rightarrow E_{2-2} +_{2-2} E_{2-2}$

Items ₁	Items ₂	Items ₃
$S \rightarrow \cdot E @1$	$E \rightarrow (\cdot E) @1$	$E \rightarrow (E) \cdot @1$
$E \rightarrow \cdot E + E @1$	$E \rightarrow \cdot E + E @2$	$S \rightarrow E \cdot @1$
$E \rightarrow \cdot (E) @1$	$E \rightarrow \cdot (E) @2$	$E \rightarrow E \cdot + E @1$
$E \rightarrow \cdot \text{int} @1$	$E \rightarrow \cdot \text{int} @2$	$E \rightarrow E + E \cdot @1$
$E \rightarrow \text{int} \cdot @1$	$E \rightarrow \text{int} \cdot @2$	$E \rightarrow E + \cdot E @1$
$S \rightarrow E \cdot @1$	$E \rightarrow (E \cdot) @1$	
$E \rightarrow E \cdot + E @1$	$E \rightarrow E \cdot + E @2$	
$E \rightarrow E + \cdot E @1$	$E \rightarrow E + \cdot E @2$	
$E \rightarrow E + E \cdot @1$	$E \rightarrow E + E \cdot @2$	

$S \rightarrow E$
 $E \rightarrow E + E$
 $E \rightarrow \text{int}$
 $E \rightarrow (E)$

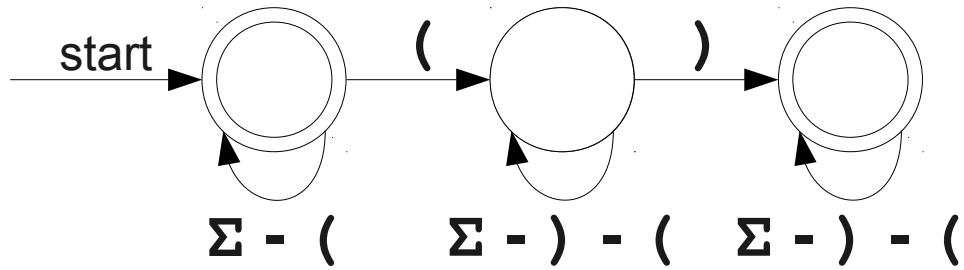

SCAN
 COMPLETE
 PREDICT

$E_{1-1} \rightarrow \text{int}_{1-1}$
 $S_{1-1} \rightarrow E_{1-1}$
 $E_{2-2} \rightarrow \text{int}_{2-2}$
 $E_{1-1} \rightarrow E_{1-1} +_{1-1} E_{1-1}$
 $E_{1-3} \rightarrow (_{1-2} E_{2-2})_{2-3}$
 $S_{1-3} \rightarrow E_{1-3}$
 $E_{1-3} \rightarrow E_{1-1} +_{1-1} E_{1-3}$
 $E_{2-2} \rightarrow E_{2-2} +_{2-2} E_{2-2}$

Items ₁	Items ₂	Items ₃
$S \rightarrow \cdot E @1$	$E \rightarrow (\cdot E) @1$	$E \rightarrow (E) \cdot @1$
$E \rightarrow \cdot E + E @1$	$E \rightarrow \cdot E + E @2$	$S \rightarrow E \cdot @1$
$E \rightarrow \cdot (E) @1$	$E \rightarrow \cdot (E) @2$	$E \rightarrow E \cdot + E @1$
$E \rightarrow \cdot \text{int} @1$	$E \rightarrow \cdot \text{int} @2$	$E \rightarrow E + E \cdot @1$
$E \rightarrow \text{int} \cdot @1$	$E \rightarrow \text{int} \cdot @2$	$E \rightarrow E + \cdot E @1$
$S \rightarrow E \cdot @1$	$E \rightarrow (E \cdot) @1$	
$E \rightarrow E \cdot + E @1$	$E \rightarrow E \cdot + E @2$	
$E \rightarrow E + \cdot E @1$	$E \rightarrow E + \cdot E @2$	
$E \rightarrow E + E \cdot @1$	$E \rightarrow E + E \cdot @2$	

$S \rightarrow E$
 $E \rightarrow E + E$
 $E \rightarrow \text{int}$
 $E \rightarrow (E)$

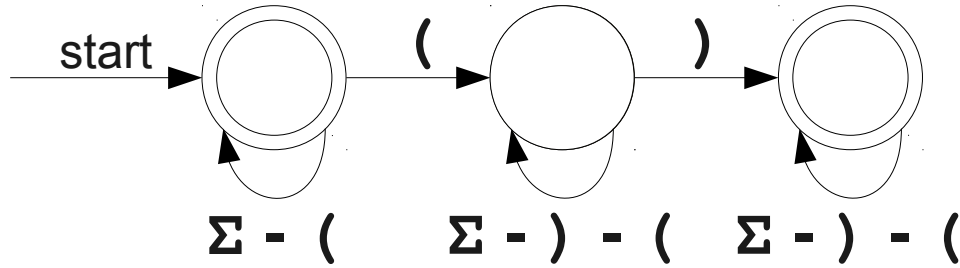

SCAN
 COMPLETE
 PREDICT

$E_{1-1} \rightarrow \text{int}_{1-1}$
 $S_{1-1} \rightarrow E_{1-1}$
 $E_{2-2} \rightarrow \text{int}_{2-2}$
 $E_{1-1} \rightarrow E_{1-1} +_{1-1} E_{1-1}$
 $E_{1-3} \rightarrow (_{1-2} E_{2-2})_{2-3}$
 $S_{1-3} \rightarrow E_{1-3}$
 $E_{1-3} \rightarrow E_{1-1} +_{1-1} E_{1-3}$
 $E_{2-2} \rightarrow E_{2-2} +_{2-2} E_{2-2}$

Items ₁	Items ₂	Items ₃
$S \rightarrow \cdot E @1$	$E \rightarrow (\cdot E) @1$	$E \rightarrow (E) \cdot @1$
$E \rightarrow \cdot E + E @1$	$E \rightarrow \cdot E + E @2$	$S \rightarrow E \cdot @1$
$E \rightarrow \cdot (E) @1$	$E \rightarrow \cdot (E) @2$	$E \rightarrow E \cdot + E @1$
$E \rightarrow \cdot \text{int} @1$	$E \rightarrow \cdot \text{int} @2$	$E \rightarrow E + E \cdot @1$
$E \rightarrow \text{int} \cdot @1$	$E \rightarrow \text{int} \cdot @2$	$E \rightarrow E + \cdot E @1$
$S \rightarrow E \cdot @1$	$E \rightarrow (E \cdot) @1$	$E \rightarrow \cdot E + E @3$
$E \rightarrow E \cdot + E @1$	$E \rightarrow E \cdot + E @2$	$E \rightarrow \cdot (E) @3$
$E \rightarrow E + \cdot E @1$	$E \rightarrow E + \cdot E @2$	$E \rightarrow \cdot \text{int} @3$
$E \rightarrow E + E \cdot @1$	$E \rightarrow E + E \cdot @2$	

$S \rightarrow E$
 $E \rightarrow E + E$
 $E \rightarrow \mathbf{int}$
 $E \rightarrow (E)$

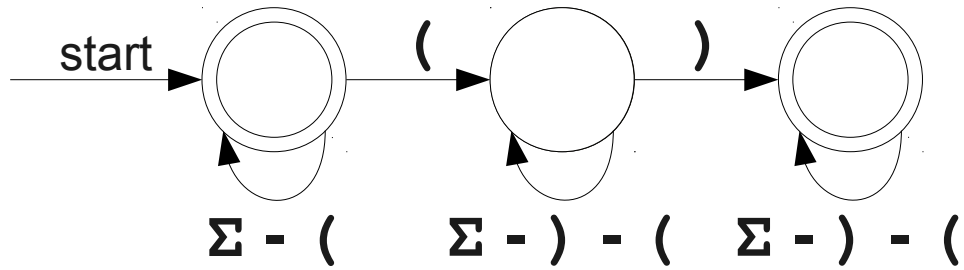

SCAN
COMPLETE
PREDICT

$E_{1-1} \rightarrow \mathbf{int}_{1-1}$
 $S_{1-1} \rightarrow E_{1-1}$
 $E_{2-2} \rightarrow \mathbf{int}_{2-2}$
 $E_{1-1} \rightarrow E_{1-1} +_{1-1} E_{1-1}$
 $E_{1-3} \rightarrow (_{1-2} E_{2-2})_{2-3}$
 $S_{1-3} \rightarrow E_{1-3}$
 $E_{1-3} \rightarrow E_{1-1} +_{1-1} E_{1-3}$
 $E_{2-2} \rightarrow E_{2-2} +_{2-2} E_{2-2}$

Items ₁	Items ₂	Items ₃
$S \rightarrow \cdot E @1$	$E \rightarrow (\cdot E) @1$	$E \rightarrow (E) \cdot @1$
$E \rightarrow \cdot E + E @1$	$E \rightarrow \cdot E + E @2$	$S \rightarrow E \cdot @1$
$E \rightarrow \cdot (E) @1$	$E \rightarrow \cdot (E) @2$	$E \rightarrow E \cdot + E @1$
$E \rightarrow \cdot \mathbf{int} @1$	$E \rightarrow \cdot \mathbf{int} @2$	$E \rightarrow E + E \cdot @1$
$E \rightarrow \mathbf{int} \cdot @1$	$E \rightarrow \mathbf{int} \cdot @2$	$E \rightarrow E + \cdot E @1$
$S \rightarrow E \cdot @1$	$E \rightarrow (E \cdot) @1$	$E \rightarrow \cdot E + E @3$
$E \rightarrow E \cdot + E @1$	$E \rightarrow E \cdot + E @2$	$E \rightarrow \cdot (E) @3$
$E \rightarrow E + \cdot E @1$	$E \rightarrow E + \cdot E @2$	$E \rightarrow \cdot \mathbf{int} @3$
$E \rightarrow E + E \cdot @1$	$E \rightarrow E + E \cdot @2$	

$S \rightarrow E$
 $E \rightarrow E + E$
 $E \rightarrow \text{int}$
 $E \rightarrow (E)$

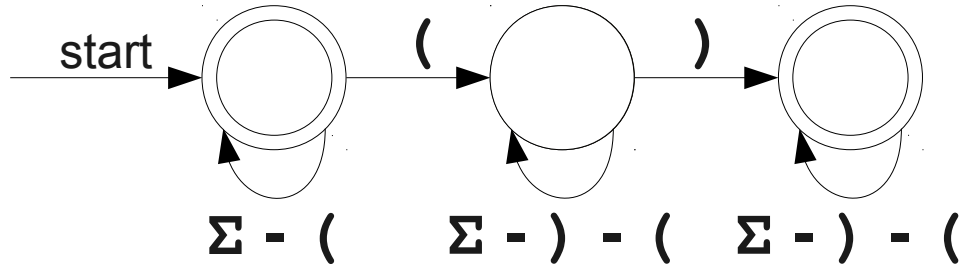

SCAN
COMPLETE
PREDICT

$E_{1-1} \rightarrow \text{int}_{1-1}$
 $S_{1-1} \rightarrow E_{1-1}$
 $E_{2-2} \rightarrow \text{int}_{2-2}$
 $E_{1-1} \rightarrow E_{1-1} +_{1-1} E_{1-1}$
 $E_{1-3} \rightarrow (_{1-2} E_{2-2})_{2-3}$
 $S_{1-3} \rightarrow E_{1-3}$
 $E_{1-3} \rightarrow E_{1-1} +_{1-1} E_{1-3}$
 $E_{2-2} \rightarrow E_{2-2} +_{2-2} E_{2-2}$

Items ₁	Items ₂	Items ₃
$S \rightarrow \cdot E @1$	$E \rightarrow (\cdot E) @1$	$E \rightarrow (E) \cdot @1$
$E \rightarrow \cdot E + E @1$	$E \rightarrow \cdot E + E @2$	$S \rightarrow E \cdot @1$
$E \rightarrow \cdot (E) @1$	$E \rightarrow \cdot (E) @2$	$E \rightarrow E \cdot + E @1$
$E \rightarrow \cdot \text{int} @1$	$E \rightarrow \cdot \text{int} @2$	$E \rightarrow E + E \cdot @1$
$E \rightarrow \text{int} \cdot @1$	$E \rightarrow \text{int} \cdot @2$	$E \rightarrow E + \cdot E @1$
$S \rightarrow E \cdot @1$	$E \rightarrow (E \cdot) @1$	$E \rightarrow \cdot E + E @3$
$E \rightarrow E \cdot + E @1$	$E \rightarrow E \cdot + E @2$	$E \rightarrow \cdot (E) @3$
$E \rightarrow E + \cdot E @1$	$E \rightarrow E + \cdot E @2$	$E \rightarrow \cdot \text{int} @3$
$E \rightarrow E + E \cdot @1$	$E \rightarrow E + E \cdot @2$	$E \rightarrow \text{int} \cdot @3$

$S \rightarrow E$
 $E \rightarrow E + E$
 $E \rightarrow \mathbf{int}$
 $E \rightarrow (E)$

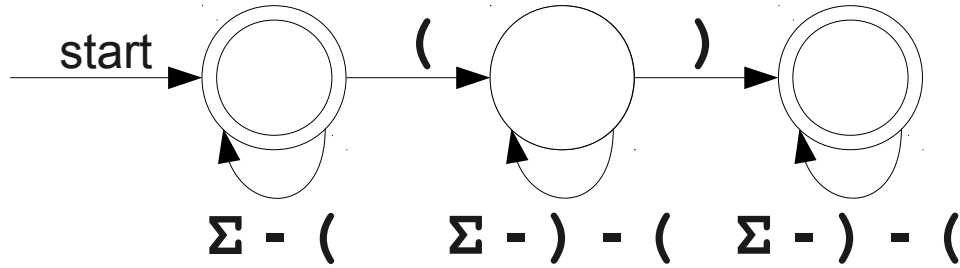

SCAN
 COMPLETE
 PREDICT

$E_{1-1} \rightarrow \mathbf{int}_{1-1}$
 $S_{1-1} \rightarrow E_{1-1}$
 $E_{2-2} \rightarrow \mathbf{int}_{2-2}$
 $E_{1-1} \rightarrow E_{1-1} +_{1-1} E_{1-1}$
 $E_{1-3} \rightarrow (_{1-2} E_{2-2})_{2-3}$
 $S_{1-3} \rightarrow E_{1-3}$
 $E_{1-3} \rightarrow E_{1-1} +_{1-1} E_{1-3}$
 $E_{2-2} \rightarrow E_{2-2} +_{2-2} E_{2-2}$

Items ₁	Items ₂	Items ₃
$S \rightarrow \cdot E @1$	$E \rightarrow (\cdot E) @1$	$E \rightarrow (E) \cdot @1$
$E \rightarrow \cdot E + E @1$	$E \rightarrow \cdot E + E @2$	$S \rightarrow E \cdot @1$
$E \rightarrow \cdot (E) @1$	$E \rightarrow \cdot (E) @2$	$E \rightarrow E \cdot + E @1$
$E \rightarrow \cdot \mathbf{int} @1$	$E \rightarrow \cdot \mathbf{int} @2$	$E \rightarrow E + E \cdot @1$
$E \rightarrow \mathbf{int} \cdot @1$	$E \rightarrow \mathbf{int} \cdot @2$	$E \rightarrow E + \cdot E @1$
$S \rightarrow E \cdot @1$	$E \rightarrow (E \cdot) @1$	$E \rightarrow \cdot E + E @3$
$E \rightarrow E \cdot + E @1$	$E \rightarrow E \cdot + E @2$	$E \rightarrow \cdot (E) @3$
$E \rightarrow E + \cdot E @1$	$E \rightarrow E + \cdot E @2$	$E \rightarrow \cdot \mathbf{int} @3$
$E \rightarrow E + E \cdot @1$	$E \rightarrow E + E \cdot @2$	$E \rightarrow \mathbf{int} \cdot @3$

$S \rightarrow E$
 $E \rightarrow E + E$
 $E \rightarrow \mathbf{int}$
 $E \rightarrow (E)$

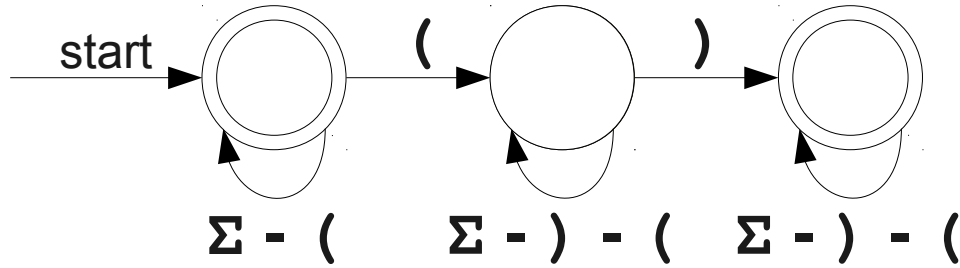

SCAN
 COMPLETE
 PREDICT

$E_{1-1} \rightarrow \mathbf{int}_{1-1}$
 $S_{1-1} \rightarrow E_{1-1}$
 $E_{2-2} \rightarrow \mathbf{int}_{2-2}$
 $E_{1-1} \rightarrow E_{1-1} +_{1-1} E_{1-1}$
 $E_{1-3} \rightarrow (_{1-2} E_{2-2})_{2-3}$
 $S_{1-3} \rightarrow E_{1-3}$
 $E_{1-3} \rightarrow E_{1-1} +_{1-1} E_{1-3}$
 $E_{2-2} \rightarrow E_{2-2} +_{2-2} E_{2-2}$
 $E_{3-3} \rightarrow \mathbf{int}_{3-3}$

Items ₁	Items ₂	Items ₃
$S \rightarrow \cdot E @1$	$E \rightarrow (\cdot E) @1$	$E \rightarrow (E) \cdot @1$
$E \rightarrow \cdot E + E @1$	$E \rightarrow \cdot E + E @2$	$S \rightarrow E \cdot @1$
$E \rightarrow \cdot (E) @1$	$E \rightarrow \cdot (E) @2$	$E \rightarrow E \cdot + E @1$
$E \rightarrow \cdot \mathbf{int} @1$	$E \rightarrow \cdot \mathbf{int} @2$	$E \rightarrow E + E \cdot @1$
$E \rightarrow \mathbf{int} \cdot @1$	$E \rightarrow \mathbf{int} \cdot @2$	$E \rightarrow E + \cdot E @1$
$S \rightarrow E \cdot @1$	$E \rightarrow (E \cdot) @1$	$E \rightarrow \cdot E + E @3$
$E \rightarrow E \cdot + E @1$	$E \rightarrow E \cdot + E @2$	$E \rightarrow \cdot (E) @3$
$E \rightarrow E + \cdot E @1$	$E \rightarrow E + \cdot E @2$	$E \rightarrow \cdot \mathbf{int} @3$
$E \rightarrow E + E \cdot @1$	$E \rightarrow E + E \cdot @2$	$E \rightarrow \mathbf{int} \cdot @3$

$S \rightarrow E$
 $E \rightarrow E + E$
 $E \rightarrow \text{int}$
 $E \rightarrow (E)$

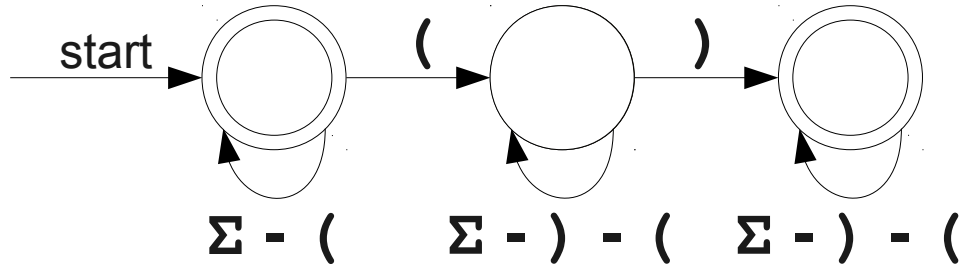

SCAN
 COMPLETE
 PREDICT

$E_{1-1} \rightarrow \text{int}_{1-1}$
 $S_{1-1} \rightarrow E_{1-1}$
 $E_{2-2} \rightarrow \text{int}_{2-2}$
 $E_{1-1} \rightarrow E_{1-1} +_{1-1} E_{1-1}$
 $E_{1-3} \rightarrow (_{1-2} E_{2-2})_{2-3}$
 $S_{1-3} \rightarrow E_{1-3}$
 $E_{1-3} \rightarrow E_{1-1} +_{1-1} E_{1-3}$
 $E_{2-2} \rightarrow E_{2-2} +_{2-2} E_{2-2}$
 $E_{3-3} \rightarrow \text{int}_{3-3}$

Items ₁	Items ₂	Items ₃
$S \rightarrow \cdot E @1$	$E \rightarrow (\cdot E) @1$	$E \rightarrow (E) \cdot @1$
$E \rightarrow \cdot E + E @1$	$E \rightarrow \cdot E + E @2$	$S \rightarrow E \cdot @1$
$E \rightarrow \cdot (E) @1$	$E \rightarrow \cdot (E) @2$	$E \rightarrow E \cdot + E @1$
$E \rightarrow \cdot \text{int} @1$	$E \rightarrow \cdot \text{int} @2$	$E \rightarrow E + E \cdot @1$
$E \rightarrow \text{int} \cdot @1$	$E \rightarrow \text{int} \cdot @2$	$E \rightarrow E + \cdot E @1$
$S \rightarrow E \cdot @1$	$E \rightarrow (E \cdot) @1$	$E \rightarrow \cdot E + E @3$
$E \rightarrow E \cdot + E @1$	$E \rightarrow E \cdot + E @2$	$E \rightarrow \cdot (E) @3$
$E \rightarrow E + \cdot E @1$	$E \rightarrow E + \cdot E @2$	$E \rightarrow \cdot \text{int} @3$
$E \rightarrow E + E \cdot @1$	$E \rightarrow E + E \cdot @2$	$E \rightarrow \text{int} \cdot @3$
		$E \rightarrow E + E \cdot @1$
		$E \rightarrow E \cdot + E @3$

$S \rightarrow E$
 $E \rightarrow E + E$
 $E \rightarrow \mathbf{int}$
 $E \rightarrow (E)$

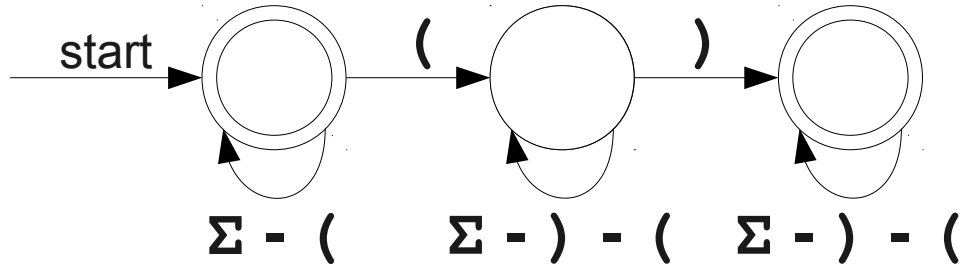

SCAN
 COMPLETE
 PREDICT

$E_{1-1} \rightarrow \mathbf{int}_{1-1}$
 $S_{1-1} \rightarrow E_{1-1}$
 $E_{2-2} \rightarrow \mathbf{int}_{2-2}$
 $E_{1-1} \rightarrow E_{1-1} +_{1-1} E_{1-1}$
 $E_{1-3} \rightarrow (_{1-2} E_{2-2})_{2-3}$
 $S_{1-3} \rightarrow E_{1-3}$
 $E_{1-3} \rightarrow E_{1-1} +_{1-1} E_{1-3}$
 $E_{2-2} \rightarrow E_{2-2} +_{2-2} E_{2-2}$
 $E_{3-3} \rightarrow \mathbf{int}_{3-3}$
 $E_{1-3} \rightarrow E_{1-3} +_{1-3} E_{3-3}$

Items ₁	Items ₂	Items ₃
$S \rightarrow \cdot E @1$	$E \rightarrow (\cdot E) @1$	$E \rightarrow (E) \cdot @1$
$E \rightarrow \cdot E + E @1$	$E \rightarrow \cdot E + E @2$	$S \rightarrow E \cdot @1$
$E \rightarrow \cdot (E) @1$	$E \rightarrow \cdot (E) @2$	$E \rightarrow E \cdot + E @1$
$E \rightarrow \cdot \mathbf{int} @1$	$E \rightarrow \cdot \mathbf{int} @2$	$E \rightarrow E + E \cdot @1$
$E \rightarrow \mathbf{int} \cdot @1$	$E \rightarrow \mathbf{int} \cdot @2$	$E \rightarrow E + \cdot E @1$
$S \rightarrow E \cdot @1$	$E \rightarrow (E \cdot) @1$	$E \rightarrow \cdot E + E @3$
$E \rightarrow E \cdot + E @1$	$E \rightarrow E \cdot + E @2$	$E \rightarrow \cdot (E) @3$
$E \rightarrow E + \cdot E @1$	$E \rightarrow E + \cdot E @2$	$E \rightarrow \cdot \mathbf{int} @3$
$E \rightarrow E + E \cdot @1$	$E \rightarrow E + E \cdot @2$	$E \rightarrow \mathbf{int} \cdot @3$
		$E \rightarrow E + E \cdot @1$
		$E \rightarrow E \cdot + E @3$

$S \rightarrow E$
 $E \rightarrow E + E$
 $E \rightarrow \mathbf{int}$
 $E \rightarrow (E)$

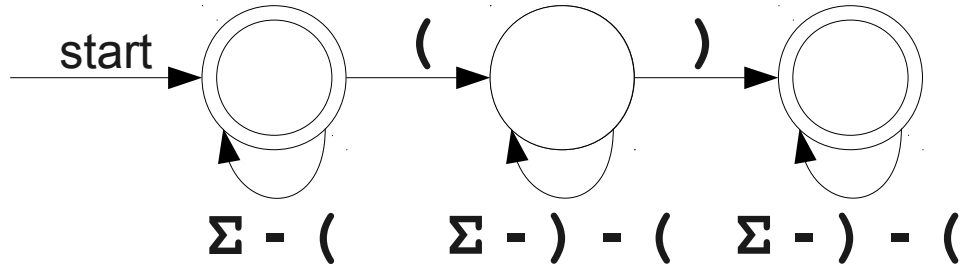

SCAN
 COMPLETE
 PREDICT

$E_{1-1} \rightarrow \mathbf{int}_{1-1}$
 $S_{1-1} \rightarrow E_{1-1}$
 $E_{2-2} \rightarrow \mathbf{int}_{2-2}$
 $E_{1-1} \rightarrow E_{1-1} +_{1-1} E_{1-1}$
 $E_{1-3} \rightarrow (_{1-2} E_{2-2})_{2-3}$
 $S_{1-3} \rightarrow E_{1-3}$
 $E_{1-3} \rightarrow E_{1-1} +_{1-1} E_{1-3}$
 $E_{2-2} \rightarrow E_{2-2} +_{2-2} E_{2-2}$
 $E_{3-3} \rightarrow \mathbf{int}_{3-3}$
 $E_{1-3} \rightarrow E_{1-3} +_{1-3} E_{3-3}$

Items ₁	Items ₂	Items ₃
$S \rightarrow \cdot E @1$	$E \rightarrow (\cdot E) @1$	$E \rightarrow (E) \cdot @1$
$E \rightarrow \cdot E + E @1$	$E \rightarrow \cdot E + E @2$	$S \rightarrow E \cdot @1$
$E \rightarrow \cdot (E) @1$	$E \rightarrow \cdot (E) @2$	$E \rightarrow E \cdot + E @1$
$E \rightarrow \cdot \mathbf{int} @1$	$E \rightarrow \cdot \mathbf{int} @2$	$E \rightarrow E + E \cdot @1$
$E \rightarrow \mathbf{int} \cdot @1$	$E \rightarrow \mathbf{int} \cdot @2$	$E \rightarrow E + \cdot E @1$
$S \rightarrow E \cdot @1$	$E \rightarrow (E \cdot) @1$	$E \rightarrow \cdot E + E @3$
$E \rightarrow E \cdot + E @1$	$E \rightarrow E \cdot + E @2$	$E \rightarrow \cdot (E) @3$
$E \rightarrow E + \cdot E @1$	$E \rightarrow E + \cdot E @2$	$E \rightarrow \cdot \mathbf{int} @3$
$E \rightarrow E + E \cdot @1$	$E \rightarrow E + E \cdot @2$	$E \rightarrow \mathbf{int} \cdot @3$
		$E \rightarrow E + E \cdot @1$
		$E \rightarrow E \cdot + E @3$

$S \rightarrow E$
 $E \rightarrow E + E$
 $E \rightarrow \text{int}$
 $E \rightarrow (E)$

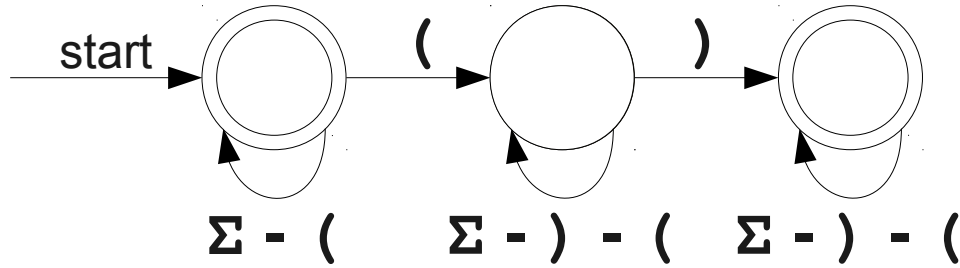

SCAN
COMPLETE
PREDICT

$E_{1-1} \rightarrow \text{int}_{1-1}$
 $S_{1-1} \rightarrow E_{1-1}$
 $E_{2-2} \rightarrow \text{int}_{2-2}$
 $E_{1-1} \rightarrow E_{1-1} +_{1-1} E_{1-1}$
 $E_{1-3} \rightarrow (_{1-2} E_{2-2})_{2-3}$
 $S_{1-3} \rightarrow E_{1-3}$
 $E_{1-3} \rightarrow E_{1-1} +_{1-1} E_{1-3}$
 $E_{2-2} \rightarrow E_{2-2} +_{2-2} E_{2-2}$
 $E_{3-3} \rightarrow \text{int}_{3-3}$
 $E_{1-3} \rightarrow E_{1-3} +_{1-3} E_{3-3}$

Items ₁
$S \rightarrow \cdot E @1$
$E \rightarrow \cdot E + E @1$
$E \rightarrow \cdot (E) @1$
$E \rightarrow \cdot \text{int} @1$
$E \rightarrow \text{int} \cdot @1$
$S \rightarrow E \cdot @1$
$E \rightarrow E \cdot + E @1$
$E \rightarrow E + \cdot E @1$
$E \rightarrow E + E \cdot @1$

Items ₂
$E \rightarrow (\cdot E) @1$
$E \rightarrow \cdot E + E @2$
$E \rightarrow \cdot (E) @2$
$E \rightarrow \cdot \text{int} @2$
$E \rightarrow \text{int} \cdot @2$
$E \rightarrow (E \cdot) @1$
$E \rightarrow E \cdot + E @2$
$E \rightarrow E + \cdot E @2$
$E \rightarrow E + E \cdot @2$

Items ₃
$E \rightarrow (E) \cdot @1$
$S \rightarrow E \cdot @1$
$E \rightarrow E \cdot + E @1$
$E \rightarrow E + E \cdot @1$
$E \rightarrow E + \cdot E @1$
$E \rightarrow \cdot E + E @3$
$E \rightarrow \cdot (E) @3$
$E \rightarrow \cdot \text{int} @3$
$E \rightarrow \text{int} \cdot @3$
$E \rightarrow E + E \cdot @1$
$E \rightarrow E \cdot + E @3$

$S \rightarrow E$
 $E \rightarrow E + E$
 $E \rightarrow \text{int}$
 $E \rightarrow (E)$

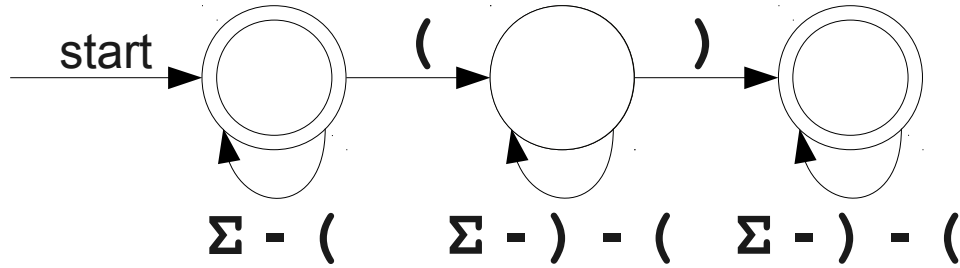

SCAN
COMPLETE
PREDICT

$E_{1-1} \rightarrow \text{int}_{1-1}$
 $S_{1-1} \rightarrow E_{1-1}$
 $E_{2-2} \rightarrow \text{int}_{2-2}$
 $E_{1-1} \rightarrow E_{1-1} +_{1-1} E_{1-1}$
 $E_{1-3} \rightarrow (_{1-2} E_{2-2})_{2-3}$
 $S_{1-3} \rightarrow E_{1-3}$
 $E_{1-3} \rightarrow E_{1-1} +_{1-1} E_{1-3}$
 $E_{2-2} \rightarrow E_{2-2} +_{2-2} E_{2-2}$
 $E_{3-3} \rightarrow \text{int}_{3-3}$
 $E_{1-3} \rightarrow E_{1-3} +_{1-3} E_{3-3}$

Items ₁
$S \rightarrow \cdot E @1$
$E \rightarrow \cdot E + E @1$
$E \rightarrow \cdot (E) @1$
$E \rightarrow \cdot \text{int} @1$
$E \rightarrow \text{int} \cdot @1$
$S \rightarrow E \cdot @1$
$E \rightarrow E \cdot + E @1$
$E \rightarrow E + \cdot E @1$
$E \rightarrow E + E \cdot @1$

Items ₂
$E \rightarrow (\cdot E) @1$
$E \rightarrow \cdot E + E @2$
$E \rightarrow \cdot (E) @2$
$E \rightarrow \cdot \text{int} @2$
$E \rightarrow \text{int} \cdot @2$
$E \rightarrow (E \cdot) @1$
$E \rightarrow E \cdot + E @2$
$E \rightarrow E + \cdot E @2$
$E \rightarrow E + E \cdot @2$

Items ₃
$E \rightarrow (E) \cdot @1$
$S \rightarrow E \cdot @1$
$E \rightarrow E \cdot + E @1$
$E \rightarrow E + E \cdot @1$
$E \rightarrow E + \cdot E @1$
$E \rightarrow \cdot E + E @3$
$E \rightarrow \cdot (E) @3$
$E \rightarrow \cdot \text{int} @3$
$E \rightarrow \text{int} \cdot @3$
$E \rightarrow E + E \cdot @1$
$E \rightarrow E \cdot + E @3$
$E \rightarrow E + \cdot E @3$

$S \rightarrow E$
 $E \rightarrow E + E$
 $E \rightarrow \mathbf{int}$
 $E \rightarrow (E)$

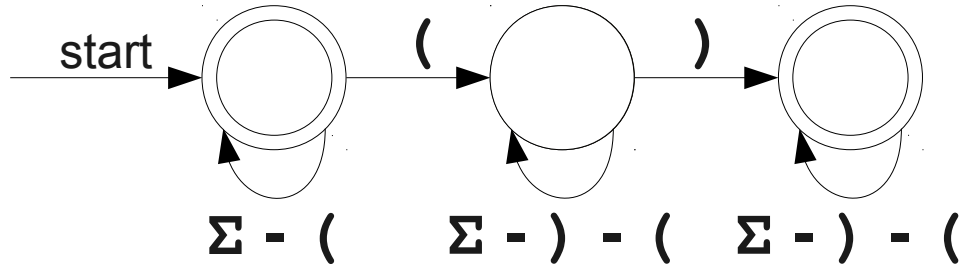

SCAN

COMPLETE

PREDICT

$E_{1-1} \rightarrow \mathbf{int}_{1-1}$
 $S_{1-1} \rightarrow E_{1-1}$
 $E_{2-2} \rightarrow \mathbf{int}_{2-2}$
 $E_{1-1} \rightarrow E_{1-1} +_{1-1} E_{1-1}$
 $E_{1-3} \rightarrow (_{1-2} E_{2-2})_{2-3}$
 $S_{1-3} \rightarrow E_{1-3}$
 $E_{1-3} \rightarrow E_{1-1} +_{1-1} E_{1-3}$
 $E_{2-2} \rightarrow E_{2-2} +_{2-2} E_{2-2}$
 $E_{3-3} \rightarrow \mathbf{int}_{3-3}$
 $E_{1-3} \rightarrow E_{1-3} +_{1-3} E_{3-3}$

Items ₁
$S \rightarrow \cdot E @1$
$E \rightarrow \cdot E + E @1$
$E \rightarrow \cdot (E) @1$
$E \rightarrow \cdot \mathbf{int} @1$
$E \rightarrow \mathbf{int} \cdot @1$
$S \rightarrow E \cdot @1$
$E \rightarrow E \cdot + E @1$
$E \rightarrow E + \cdot E @1$
$E \rightarrow E + E \cdot @1$

Items ₂
$E \rightarrow (\cdot E) @1$
$E \rightarrow \cdot E + E @2$
$E \rightarrow \cdot (E) @2$
$E \rightarrow \cdot \mathbf{int} @2$
$E \rightarrow \mathbf{int} \cdot @2$
$E \rightarrow (E \cdot) @1$
$E \rightarrow E \cdot + E @2$
$E \rightarrow E + \cdot E @2$
$E \rightarrow E + E \cdot @2$

Items ₃
$E \rightarrow (E) \cdot @1$
$S \rightarrow E \cdot @1$
$E \rightarrow E \cdot + E @1$
$E \rightarrow E + E \cdot @1$
$E \rightarrow E + \cdot E @1$
$E \rightarrow \cdot E + E @3$
$E \rightarrow \cdot (E) @3$
$E \rightarrow \cdot \mathbf{int} @3$
$E \rightarrow \mathbf{int} \cdot @3$
$E \rightarrow E + E \cdot @1$
$E \rightarrow E \cdot + E @3$
$E \rightarrow E + \cdot E @3$

$S \rightarrow E$
 $E \rightarrow E + E$
 $E \rightarrow \text{int}$
 $E \rightarrow (E)$

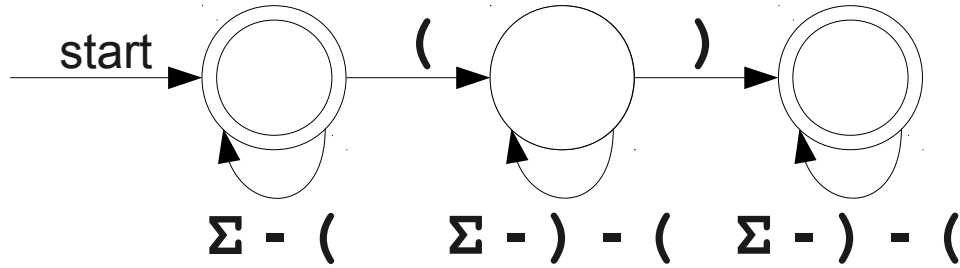

SCAN
 COMPLETE
 PREDICT

$E_{1-1} \rightarrow \text{int}_{1-1}$
 $S_{1-1} \rightarrow E_{1-1}$
 $E_{2-2} \rightarrow \text{int}_{2-2}$
 $E_{1-1} \rightarrow E_{1-1} +_{1-1} E_{1-1}$
 $E_{1-3} \rightarrow (_{1-2} E_{2-2})_{2-3}$
 $S_{1-3} \rightarrow E_{1-3}$
 $E_{1-3} \rightarrow E_{1-1} +_{1-1} E_{1-3}$
 $E_{2-2} \rightarrow E_{2-2} +_{2-2} E_{2-2}$
 $E_{3-3} \rightarrow \text{int}_{3-3}$
 $E_{1-3} \rightarrow E_{1-3} +_{1-3} E_{3-3}$

Items ₁
$S \rightarrow \cdot E @1$
$E \rightarrow \cdot E + E @1$
$E \rightarrow \cdot (E) @1$
$E \rightarrow \cdot \text{int} @1$
$E \rightarrow \text{int} \cdot @1$
$S \rightarrow E \cdot @1$
$E \rightarrow E \cdot + E @1$
$E \rightarrow E + \cdot E @1$
$E \rightarrow E + E \cdot @1$

Items ₂
$E \rightarrow (\cdot E) @1$
$E \rightarrow \cdot E + E @2$
$E \rightarrow \cdot (E) @2$
$E \rightarrow \cdot \text{int} @2$
$E \rightarrow \text{int} \cdot @2$
$E \rightarrow (E \cdot) @1$
$E \rightarrow E \cdot + E @2$
$E \rightarrow E + \cdot E @2$
$E \rightarrow E + E \cdot @2$

Items ₃
$E \rightarrow (E) \cdot @1$
$S \rightarrow E \cdot @1$
$E \rightarrow E \cdot + E @1$
$E \rightarrow E + E \cdot @1$
$E \rightarrow E + \cdot E @1$
$E \rightarrow \cdot E + E @3$
$E \rightarrow \cdot (E) @3$
$E \rightarrow \cdot \text{int} @3$
$E \rightarrow \text{int} \cdot @3$
$E \rightarrow E + E \cdot @1$
$E \rightarrow E \cdot + E @3$
$E \rightarrow E + \cdot E @3$
$E \rightarrow E + E \cdot @3$

$S \rightarrow E$
 $E \rightarrow E + E$
 $E \rightarrow \text{int}$
 $E \rightarrow (E)$

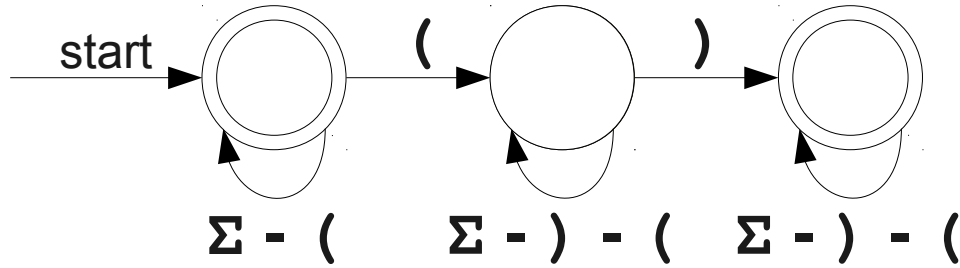

SCAN
 COMPLETE
 PREDICT

$E_{1-1} \rightarrow \text{int}_{1-1}$
 $S_{1-1} \rightarrow E_{1-1}$
 $E_{2-2} \rightarrow \text{int}_{2-2}$
 $E_{1-1} \rightarrow E_{1-1} +_{1-1} E_{1-1}$
 $E_{1-3} \rightarrow (_{1-2} E_{2-2})_{2-3}$
 $S_{1-3} \rightarrow E_{1-3}$
 $E_{1-3} \rightarrow E_{1-1} +_{1-1} E_{1-3}$
 $E_{2-2} \rightarrow E_{2-2} +_{2-2} E_{2-2}$
 $E_{3-3} \rightarrow \text{int}_{3-3}$
 $E_{1-3} \rightarrow E_{1-3} +_{1-3} E_{3-3}$
 $E_{3-3} \rightarrow E_{3-3} +_{3-3} E_{3-3}$

Items ₁
$S \rightarrow \cdot E @1$
$E \rightarrow \cdot E + E @1$
$E \rightarrow \cdot (E) @1$
$E \rightarrow \cdot \text{int} @1$
$E \rightarrow \text{int} \cdot @1$
$S \rightarrow E \cdot @1$
$E \rightarrow E \cdot + E @1$
$E \rightarrow E + \cdot E @1$
$E \rightarrow E + E \cdot @1$

Items ₂
$E \rightarrow (\cdot E) @1$
$E \rightarrow \cdot E + E @2$
$E \rightarrow \cdot (E) @2$
$E \rightarrow \cdot \text{int} @2$
$E \rightarrow \text{int} \cdot @2$
$E \rightarrow (E \cdot) @1$
$E \rightarrow E \cdot + E @2$
$E \rightarrow E + \cdot E @2$
$E \rightarrow E + E \cdot @2$

Items ₃
$E \rightarrow (E) \cdot @1$
$S \rightarrow E \cdot @1$
$E \rightarrow E \cdot + E @1$
$E \rightarrow E + E \cdot @1$
$E \rightarrow E + \cdot E @1$
$E \rightarrow \cdot E + E @3$
$E \rightarrow \cdot (E) @3$
$E \rightarrow \cdot \text{int} @3$
$E \rightarrow \text{int} \cdot @3$
$E \rightarrow E + E \cdot @1$
$E \rightarrow E \cdot + E @3$
$E \rightarrow E + \cdot E @3$
$E \rightarrow E + E \cdot @3$

$S \rightarrow E$
 $E \rightarrow E + E$
 $E \rightarrow \text{int}$
 $E \rightarrow (E)$

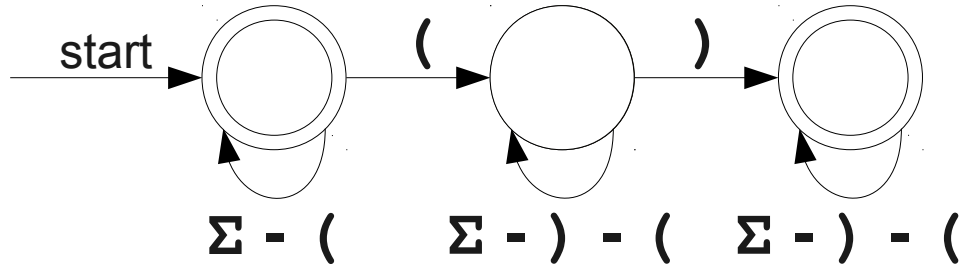

SCAN
 COMPLETE
 PREDICT

$E_{1-1} \rightarrow \text{int}_{1-1}$
 $S_{1-1} \rightarrow E_{1-1}$
 $E_{2-2} \rightarrow \text{int}_{2-2}$
 $E_{1-1} \rightarrow E_{1-1} +_{1-1} E_{1-1}$
 $E_{1-3} \rightarrow (_{1-2} E_{2-2})_{2-3}$
 $S_{1-3} \rightarrow E_{1-3}$
 $E_{1-3} \rightarrow E_{1-1} +_{1-1} E_{1-3}$
 $E_{2-2} \rightarrow E_{2-2} +_{2-2} E_{2-2}$
 $E_{3-3} \rightarrow \text{int}_{3-3}$
 $E_{1-3} \rightarrow E_{1-3} +_{1-3} E_{3-3}$
 $E_{3-3} \rightarrow E_{3-3} +_{3-3} E_{3-3}$

Items ₁
$S \rightarrow \cdot E @1$
$E \rightarrow \cdot E + E @1$
$E \rightarrow \cdot (E) @1$
$E \rightarrow \cdot \text{int} @1$
$E \rightarrow \text{int} \cdot @1$
$S \rightarrow E \cdot @1$
$E \rightarrow E \cdot + E @1$
$E \rightarrow E + \cdot E @1$
$E \rightarrow E + E \cdot @1$

Items ₂
$E \rightarrow (\cdot E) @1$
$E \rightarrow \cdot E + E @2$
$E \rightarrow \cdot (E) @2$
$E \rightarrow \cdot \text{int} @2$
$E \rightarrow \text{int} \cdot @2$
$E \rightarrow (E \cdot) @1$
$E \rightarrow E \cdot + E @2$
$E \rightarrow E + \cdot E @2$
$E \rightarrow E + E \cdot @2$

Items ₃
$E \rightarrow (E) \cdot @1$
$S \rightarrow E \cdot @1$
$E \rightarrow E \cdot + E @1$
$E \rightarrow E + E \cdot @1$
$E \rightarrow E + \cdot E @1$
$E \rightarrow \cdot E + E @3$
$E \rightarrow \cdot (E) @3$
$E \rightarrow \cdot \text{int} @3$
$E \rightarrow \text{int} \cdot @3$
$E \rightarrow E + E \cdot @1$
$E \rightarrow E \cdot + E @3$
$E \rightarrow E + \cdot E @3$
$E \rightarrow E + E \cdot @3$

$S \rightarrow E$
 $E \rightarrow E + E$
 $E \rightarrow \text{int}$
 $E \rightarrow (E)$

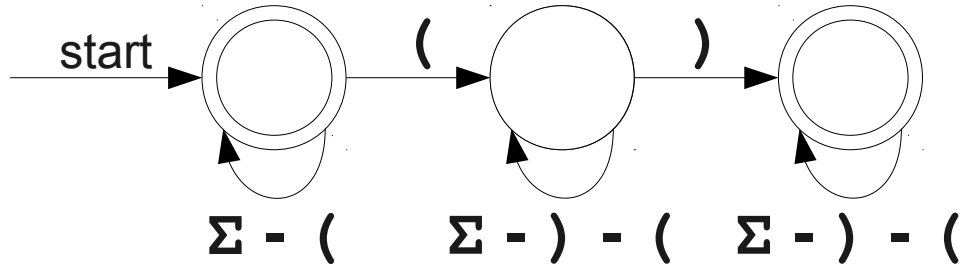

SCAN
 COMPLETE
 PREDICT

$E_{1-1} \rightarrow \text{int}_{1-1}$
 $S_{1-1} \rightarrow E_{1-1}$
 $E_{2-2} \rightarrow \text{int}_{2-2}$
 $E_{1-1} \rightarrow E_{1-1} +_{1-1} E_{1-1}$
 $E_{1-3} \rightarrow (_{1-2} E_{2-2})_{2-3}$
 $S_{1-3} \rightarrow E_{1-3}$
 $E_{1-3} \rightarrow E_{1-1} +_{1-1} E_{1-3}$
 $E_{2-2} \rightarrow E_{2-2} +_{2-2} E_{2-2}$
 $E_{3-3} \rightarrow \text{int}_{3-3}$
 $E_{1-3} \rightarrow E_{1-3} +_{1-3} E_{3-3}$
 $E_{3-3} \rightarrow E_{3-3} +_{3-3} E_{3-3}$

Items ₁
$S \rightarrow \cdot E @1$
$E \rightarrow \cdot E + E @1$
$E \rightarrow \cdot (E) @1$
$E \rightarrow \cdot \text{int} @1$
$E \rightarrow \text{int} \cdot @1$
$S \rightarrow E \cdot @1$
$E \rightarrow E \cdot + E @1$
$E \rightarrow E + \cdot E @1$
$E \rightarrow E + E \cdot @1$

Items ₂
$E \rightarrow (\cdot E) @1$
$E \rightarrow \cdot E + E @2$
$E \rightarrow \cdot (E) @2$
$E \rightarrow \cdot \text{int} @2$
$E \rightarrow \text{int} \cdot @2$
$E \rightarrow (E \cdot) @1$
$E \rightarrow E \cdot + E @2$
$E \rightarrow E + \cdot E @2$
$E \rightarrow E + E \cdot @2$

Items ₃
$E \rightarrow (E) \cdot @1$
$S \rightarrow E \cdot @1$
$E \rightarrow E \cdot + E @1$
$E \rightarrow E + E \cdot @1$
$E \rightarrow E + \cdot E @1$
$E \rightarrow \cdot E + E @3$
$E \rightarrow \cdot (E) @3$
$E \rightarrow \cdot \text{int} @3$
$E \rightarrow \text{int} \cdot @3$
$E \rightarrow E + E \cdot @1$
$E \rightarrow E \cdot + E @3$
$E \rightarrow E + \cdot E @3$
$E \rightarrow E + E \cdot @3$

$S \rightarrow E$
 $E \rightarrow E + E$
 $E \rightarrow \text{int}$
 $E \rightarrow (E)$

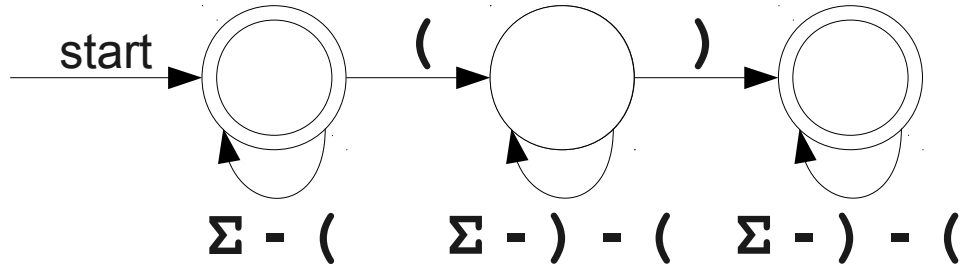

SCAN
 COMPLETE
 PREDICT

$S \rightarrow S_{1-1} \mid S_{1-3}$
 $E_{1-1} \rightarrow \text{int}_{1-1}$
 $S_{1-1} \rightarrow E_{1-1}$
 $E_{2-2} \rightarrow \text{int}_{2-2}$
 $E_{1-1} \rightarrow E_{1-1} +_{1-1} E_{1-1}$
 $E_{1-3} \rightarrow (_{1-2} E_{2-2})_{2-3}$
 $S_{1-3} \rightarrow E_{1-3}$
 $E_{1-3} \rightarrow E_{1-1} +_{1-1} E_{1-3}$
 $E_{2-2} \rightarrow E_{2-2} +_{2-2} E_{2-2}$
 $E_{3-3} \rightarrow \text{int}_{3-3}$
 $E_{1-3} \rightarrow E_{1-3} +_{1-3} E_{3-3}$
 $E_{3-3} \rightarrow E_{3-3} +_{3-3} E_{3-3}$

Items ₁
$S \rightarrow \cdot E @1$
$E \rightarrow \cdot E + E @1$
$E \rightarrow \cdot (E) @1$
$E \rightarrow \cdot \text{int} @1$
$E \rightarrow \text{int} \cdot @1$
$S \rightarrow E \cdot @1$
$E \rightarrow E \cdot + E @1$
$E \rightarrow E + \cdot E @1$
$E \rightarrow E + E \cdot @1$

Items ₂
$E \rightarrow (\cdot E) @1$
$E \rightarrow \cdot E + E @2$
$E \rightarrow \cdot (E) @2$
$E \rightarrow \cdot \text{int} @2$
$E \rightarrow \text{int} \cdot @2$
$E \rightarrow (E \cdot) @1$
$E \rightarrow E \cdot + E @2$
$E \rightarrow E + \cdot E @2$
$E \rightarrow E + E \cdot @2$

Items ₃
$E \rightarrow (E) \cdot @1$
$S \rightarrow E \cdot @1$
$E \rightarrow E \cdot + E @1$
$E \rightarrow E + E \cdot @1$
$E \rightarrow E + \cdot E @1$
$E \rightarrow \cdot E + E @3$
$E \rightarrow \cdot (E) @3$
$E \rightarrow \cdot \text{int} @3$
$E \rightarrow \text{int} \cdot @3$
$E \rightarrow E + E \cdot @1$
$E \rightarrow E \cdot + E @3$
$E \rightarrow E + \cdot E @3$
$E \rightarrow E + E \cdot @3$

Analyzing the Result

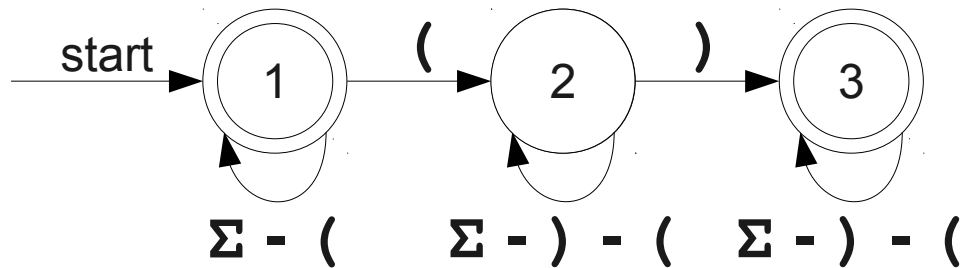

$$S \rightarrow S_{1-1}$$

$$S_{1-1} \rightarrow E_{1-1}$$

$$E_{1-1} \rightarrow \mathbf{int}_{1-1}$$

$$E_{1-1} \rightarrow E_{1-1} +_{1-1} E_{1-1}$$

$$S \rightarrow S_{1-3}$$

$$S_{1-3} \rightarrow E_{1-3}$$

$$E_{1-3} \rightarrow E_{1-1} +_{1-1} E_{1-3}$$

$$E_{1-3} \rightarrow E_{1-3} +_{1-3} E_{3-3}$$

$$E_{1-3} \rightarrow (_{1-2} E_{2-2})_{2-3}$$

$$E_{2-2} \rightarrow \mathbf{int}_{2-2}$$

$$E_{2-2} \rightarrow E_{2-2} +_{2-2} E_{2-2}$$

$$E_{3-3} \rightarrow \mathbf{int}_{3-3}$$

$$E_{3-3} \rightarrow E_{3-3} +_{3-3} E_{3-3}$$

Summary

- The **Earley algorithm** can be used to efficiently parse arbitrary CFGs.
- A **parse forest grammar** is a CFG encoding a (possibly infinite) family of parse trees.
- **Intersection parsing** treats parsing as the intersection of a CFG and a regular language.
- The **Earley-on-DFA algorithm** can be used to filter CFGs through a DFA to produce a new CFG.

Where to Go from Here

- GLR Parsing
 - **Generalized LR**
 - Conceptually similar to Earley, except based on an LR(0) automaton.
 - (Optionally) used by **bison**.
- Fast Earley Parsers
 - Many research papers discuss how to speed up Earley parsers; many are quite good.

Next Time

- **Semantic Analysis**
 - Overview of semantic analysis.
 - Scoping and symbol tables.
 - Introduction to types and type-checking.